

CPUC Self-Generation Incentive Program

Cost-Effectiveness of Distributed Generation Technologies

Final Report

Submitted to:

PG&E

Prepared by:

Itron, Inc.
2800 Fifth Street, Suite 110
Davis, CA 95618

February 9, 2011

ACKNOWLEDGMENTS

In the course of preparing this study, we relied on information from a variety of organizations and people. Information and time was shared generously by almost everyone we contacted. In addition, a number of individuals spent time examining and testing the early versions of the model as it was being developed, reviewed the interim results, and kindly provided us with comments and suggestions. We would like to acknowledge the following individuals for their contributions to this study:

- Our team members at Energy and Environmental Economics (E3), including Snuller Price, Eric Cutter, and Michael King, for sharing their economic framework on levelized costs, their helpful coordination on financial and economic issues, and their valuable contributions on storage costs and performance.
- Members of the California Clean DG Coalition, including Eric Wong, William Martini, Keith Davidson, Kirk Fowkes, Shonodeep Modak, Justin Rathke, Joel Martin, and many others, for taking the time and effort to test the early versions of the SGIPce model and for providing valuable feedback on the model and DG/CHP technology costs and performance.
- Dr. Scott Samuelson and Dr. Lori Schell for reviewing and providing constructive advice and suggestions on fuel cell costs and performance.
- Neal Reardon, Melissa Charles, and Molly Sterkel at the CPUC for their thoughtful guidance and helpful review of the draft documents, interim results, and early versions of the SGIPce model.

List of Abbreviations, Acronyms, and Model Designations Used in this Report

Common Abbreviations

Technologies

CHP	combined heat and power
DG	distributed generation
FC	fuel cells
GT	gas turbines
IC engines	internal combustion engines
MT	microturbines
ORC	Organic Rankine Cycle
PV	photovoltaic

Economics/Financing

EPBB	expected performance based buydown
LCOE	levelized cost of energy
MIRR	modified internal rate of return
PA	program administrator
PBI	performance based incentive
PCT	participant cost test
PPA	power purchase agreement
STRC	societal total resource cost
TRC	total resource cost

Emissions/Benefits

GHG	greenhouse gas
NEM	net energy metering
REC	renewable energy credit

SGIPce Modeling Technologies

DIRBGas	directed biogas
GNP	government/non-profit
NG	natural gas
NR	non-residential
OSB	on-site biogas

Model Designations

Fuel Cell

FC1200kW_NR_DIRBGas	1.2 MW, Non-Residential, Directed Biogas Fuel Cell (CHP)
FC1200kW_NR_NG	1.2 MW, Non-Residential, Natural Gas Fuel Cell (CHP)
FC1200kW_NR_OSBGas	1.2 MW, Non-Residential, Onsite Biogas (CHP)
FC1200kWe_NR_DIRBGas	1.2 MW, Non-Residential, Directed Biogas Fuel Cell, Non-CHP (i.e., Electric Only)
FC1200kWe_NR_NG	1.2 MW, Non-Residential, Natural Gas Fuel Cell, Non-CHP (i.e., Electric Only)
FC1200kWe_NR_OSBGas	1.2 MW, Non-Residential, Onsite Biogas Fuel Cell, Non-CHP (i.e., Electric Only)
FC5kW_RES_NG	5 kW, Residential, Natural Gas Fuel Cell, Non-CHP

Gas Turbine

GTg2to5MW_NR_DIRBGas	2 to 5 MW, Non-Residential, Directed Biogas Gas Turbine
GTg2to5MW_NR_NG	2 to 5 MW, Non-Residential, Natural Gas, Gas Turbine
GTg2to5MW_NR_OSBGas	2 to 5 MW, Non-Residential, Onsite Biogas, Gas Turbine
GTle2MW_NR_DIRBGas	less than 2 MW, Non-Residential, Directed Biogas, Gas Turbine
GTle2MW_NR_NG	less than 2 MW, Non-Residential, Natural Gas, Gas Turbine
GTle2MW_NR_OSBGas	less than 2 MW, Non-Residential, Onsite Biogas, Gas Turbine

Internal Combustion (IC) Engine

ICE1500kW_NR_DIRBGas	1500 kW, Non-Residential, Directed Biogas, IC engine
ICE1500kW_NR_NG	1500 kW, Non-Residential, Natural Gas, IC engine
ICE1500kW_NR_OSBGas	1500 kW, Non-Residential, Onsite Biogas, IC engine
ICE500kW_NR_DIRBGas	500 kW, Non-Residential, Directed Biogas, IC engine
ICE500kW_NR_NG	500 kW, Non-Residential, Natural Gas, IC engine
ICE500kW_NR_OSBGas	500 kW, Non-Residential, Onsite Biogas, IC engine

Microturbine

MT200kW_NR_DIRBGas	200 kW, Non-Residential, Directed Biogas, Microturbine
MT200kW_NR_NG	200 kW, Non-Residential, Natural Gas, Microturbine
MT200kW_NR_OSBGas	200 kW, Non-Residential, Onsite Biogas, Microturbine

Organic Rankine Cycle (ORC)

ORC500kW_NR_NA	500 kW, Non-Residential, No Fuel Specified, ORC
----------------	---

Storage

Storage1MW_NR_NA	1 MW, Non-Residential, No Fuel Specified, Storage
Storage25kW_NR_NA	25 kW, Non-Residential, No Fuel Specified, Storage
Storage25kW_Res_NA	25 kW, Residential, No Fuel Specified, Storage

Wind

WD1MW_NR_NA	1 MW, Non-Residential, No Fuel, Wind
-------------	--------------------------------------

Table of Contents

1 Executive Summary	1-1
2 Introduction and Background	2-1
2.1 Distributed Generation Resources in California	2-1
2.1.1 Defining Distributed Generation	2-1
2.1.2 Historical and Current Status of DG in California	2-1
2.2 Costs and Benefits of DG Technologies	2-2
2.2.1 Drivers to DG Technology Costs	2-3
2.2.2 Drivers to DG Technology Benefits	2-4
2.2.3 DG Cost-Effectiveness Project	2-6
3 Critical Inputs, Assumptions, and Cost-Effectiveness Methodology	3-1
3.1 Critical Inputs and Assumptions	3-1
3.1.1 Critical Inputs—Benefits	3-1
3.1.2 Critical Inputs—Costs	3-15
3.2 Cost-Effectiveness Methodology	3-20
3.2.1 Societal Total Resource Cost Test and the Total Resource Cost Test	3-20
3.2.2 Participant Test	3-25
3.2.3 Program Administrator Test	3-30
3.2.4 Levelized Results	3-33
3.2.5 Modified Internal Rate of Return	3-33
4 SGIPce Model Approach and Methodology	4-1
4.1 Overview	4-1
4.2 Model Objectives	4-1
4.3 Model Approach	4-2
4.4 Model Structure	4-3
4.4.1 Components	4-3
4.4.2 Functionality	4-5
4.4.3 Inputs	4-7
4.4.4 Outputs	4-9
5 Results and Observations	5-1
5.1 Societal TRC Results	5-1
5.1.1 Non-Combustion-Related Fuel Results	5-4
5.1.2 Natural Gas-Fueled Results	5-7
5.1.3 Directed Biogas Fuel Results	5-13
5.1.4 On-site Biogas-Fueled Results	5-16
5.1.5 Internal Combustion Engines	5-20
5.1.6 Fuel Cells	5-23
5.1.7 Microturbines	5-26
5.1.8 Gas Turbines	5-27
5.2 Participant Cost Test Results	5-30
5.2.1 Statewide Results	5-30

5.2.2 Fuel Cell Results	5-34
5.2.3 Gas Turbine Results.....	5-43
5.2.4 Microturbine Results.....	5-49
5.2.5 IC Engine Results.....	5-52
5.2.6 Wind Results	5-57
5.2.7 Organic Rankine Results.....	5-59
5.2.8 Storage Results.....	5-60
5.3 Comparing Societal Total Resource Cost and Participant Cost Test Results	5-63
5.4 Program Administrator Cost Test Results.....	5-66

Appendix A Examined DG Technologies A-1

A.1 Introduction.....	A-1
A.1.1 Treatment of DG Learning Curves and Costs	A-1
A.1.2 Treatment of Biogas Collection and Processing Costs.....	A-4
A.1.3 Biogas Cleanup Costs	A-7
A.1.4 Conclusions.....	A-12
A.2 Fuel Cells	A-13
A.2.1 Technology Summary	A-13
A.2.2 Past SGIP Applications.....	A-15
A.2.3 Technology Operating Characteristics.....	A-15
A.2.4 Current Technology Capital Costs.....	A-20
A.2.5 Technology Operating and Maintenance (O&M) Costs.....	A-22
A.2.6 Estimating Future Capital Costs	A-23
A.2.7 Impacts of Learning Curve on Capital Costs	A-25
A.3 Small Gas Turbines (<5MW)	A-26
A.3.1 Technology Summary	A-26
A.3.2 Technology Operating Characteristics.....	A-28
A.3.3 Current Technology Capital Costs	A-35
A.3.4 Technology Operating and Maintenance (O&M) Costs.....	A-37
A.3.5 Estimating Future Capital Costs	A-38
A.4 IC Engines.....	A-40
A.4.1 Technology Summary	A-40
A.4.2 Past SGIP Applications.....	A-41
A.4.3 Technology Operating Characteristics.....	A-43
A.4.4 Current Technology Capital Costs	A-50
A.4.5 Technology Operating and Maintenance (O&M) Costs.....	A-51
A.4.6 Estimating Future Capital Costs	A-52
A.4.7 Impact Of Learning Curve On Capital.....	A-53
A.5 Microturbines	A-54
A.5.1 Technology Summary	A-54
A.5.2 Past SGIP Applications.....	A-56
A.5.3 Technology Operating Characteristics.....	A-56
A.5.4 Current Technology Capital Costs	A-59
A.5.5 Conclusion on Capital Costs.....	A-60
A.5.6 Technology Operating and Maintenance (O&M) Costs.....	A-61
A.5.7 Estimating Future Capital Costs	A-62
A.6 Organic Rankine Cycle	A-64
A.6.1 Technology Summary	A-64
A.6.2 Technology Operating Characteristics.....	A-65
A.6.3 Current Technology Capital Costs	A-66
A.6.4 Technology Operating and Maintenance (O&M) Costs.....	A-69
A.6.5 Estimating Future Capital Costs	A-69
A.7 Wind	A-71

A.7.1 Technology Summary	A-71
A.7.2 Current Technology Capital Costs	A-77
A.7.3 Technology Operating and Maintenance (O&M) Costs	A-80
A.7.4 Estimating Future Capital Costs	A-83
A.8 Storage	A-87
A.8.1 Technology Summary	A-87
A.8.2 Current Technology Capital Costs	A-88
A.8.3 Technology Operating and Maintenance (O&M) Costs	A-89
A.8.4 Estimating Future Capital Costs	A-90
A.8.5 Storage Dispatch	A-90
Appendix B SGIPce User Guide	B-1
Appendix C Graphs and Tables	C-1

List of Figures

Figure 1-1: Statewide Societal Total Resource Cost..... 1-3

Figure 1-2: Statewide PCT Without an Incentive..... 1-5

Figure 2-1: Learning Curve for PV Module Prices (1976-2005) 2-4

Figure 4-1: SGIPce Model Flow 4-3

Figure 4-2: Climate Regions in California..... 4-10

Figure 5-1: Statewide Societal TRC Results by Non-Combustion Fuel Type
(2010 and 2016), No Incentives 5-5

Figure 5-2: STRC Levelized Cost and Benefit Components for Non-combustible
DG Technologies, PG&E Territory, No Rebate, 2010 5-6

Figure 5-3: Hourly Avoided Cost Values for PG&E Climate Zone 3 in 2010 5-7

Figure 5-4: Statewide Societal TRC Results by Natural Gas Fuel (2010 and
2016), No Incentives 5-9

Figure 5-5: STRC Levelized Cost and Benefits for Natural Gas Technologies,
PG&E Territory, No Rebate, 2010..... 5-11

Figure 5-6: Statewide Societal TRC Results by Directed Biogas Fuel (2010 and
2016), No Incentives 5-13

Figure 5-7: STRC Levelized Cost and Benefits for Directed Biogas
Technologies, PG&E Territory, No Rebate, 2010..... 5-15

Figure 5-8: Statewide Societal TRC Results for On-site Biogas Fuel (2010 and
2016), No Incentives 5-16

Figure 5-9: STRC Levelized Cost and Benefits for On-site Biogas Technologies,
PG&E Territory, No Rebate, 2010..... 5-18

Figure 5-10: STRC Levelized Cost and Benefits for IC Engines in PG&E's
Territory, Inland, No Rebate, 2010 5-22

Figure 5-11: STRC Levelized Cost and Benefits for Fuel Cells in PG&E's
Territory, Inland, No Rebate, 2010 5-25

Figure 5-12: STRC Test Levelized Costs and Benefits for Microturbines, PG&E,
Inland, No Rebate, 2010 5-27

Figure 5-13: STRC Levelized Cost and Benefits for Gas Turbines, PG&E Territory, No Rebate, 2010.....5-29

Figure 5-14: PCT Results for Electric-Only Fuel Cell, Natural Gas (PG&E)5-34

Figure 5-15: PCT Results for Electric-Only Fuel Cell, Directed Biogas (PG&E)...5-36

Figure 5-16: PCT Results for Electric-Only Fuel Cell: On-site Biogas (PG&E).....5-37

Figure 5-17: PCT Results for Fuel Cell with Heat Recovery: Natural Gas (PG&E)5-39

Figure 5-18: PCT Results for Fuel Cell with Heat Recovery, Directed Biogas (PG&E).....5-40

Figure 5-19: PCT Results for Fuel Cell with Heat Recovery, On-site Biogas (PG&E).....5-41

Figure 5-20: PCT Results for Gas Turbines 2 to 5 MW, Natural Gas (PG&E).....5-43

Figure 5-21: PCT Results for Gas Turbines 2 to 5 MW, Directed Biogas (PG&E)5-44

Figure 5-22: PCT Results for Gas Turbines 2 to 5 MW, On-site Biogas (PG&E) .5-45

Figure 5-23: PCT Results for Gas Turbines < 2 MW, Natural Gas (PG&E)5-46

Figure 5-24: PCT Results for Gas Turbines < 2 MW, Directed Biogas (PG&E) ...5-47

Figure 5-25: PCT Results for Gas Turbines < 2 MW, On-site Biogas (PG&E)5-48

Figure 5-26: PCT Results for Microturbines at 200 kW, Natural Gas (PG&E).....5-49

Figure 5-27: PCT Results for Microturbines at 200 kW, Directed Biogas (PG&E)5-50

Figure 5-28: PCT Results for MT at 200 kW, On-site Biogas (PG&E).....5-51

Figure 5-29: PCT Results for IC Engines at 500 kW, Natural Gas (PG&E).....5-52

Figure 5-30: PCT Results for IC Engines at 500 kW, Directed Biogas (PG&E)....5-53

Figure 5-31: PCT Results for IC Engines at 500 kW, On-site Biogas (PG&E)5-54

Figure 5-32: PCT Results for IC Engines at 1,500 kW, Natural Gas (PG&E).....5-55

Figure 5-33: PCT Results for IC Engines at 1,500 kW, Directed Biogas (PG&E).5-56

Figure 5-34: PCT Results for IC Engines at 1,500 kW, On-site Biogas (PG&E) ..5-57

Figure 5-35: PCT Results for Wind at 1 MW (PG&E)5-58

Figure 5-36: PCT Results for ORC at 500 kW (PG&E) 5-59

Figure 5-37: PCT Results for Storage at 1 MW (PG&E)..... 5-61

Figure 5-38: PCT Results for Storage at 25 kW (PG&E)..... 5-62

Figure A-1: Learning Curve for PV Modules, 1976-1992..... A-2

Figure A-2: Summary of Learning Curve DG Technology Cost Projections A-3

Figure A-3: Digester Cost Based on Number of Animals A-7

Figure A-4: Example Flow Diagram for Bio Gas Cleanup System (Microturbine) . A-8

Figure A-5: Biogas Cleanup Costs as a Function of Flow Rate..... A-9

Figure A-6: Basic Fuel Cell Schematic..... A-13

Figure A-7: Performance of UTC 400 over Time A-16

Figure A-8: Representative Fuel Cell Generation Profile (SDG&E)..... A-19

Figure A-9: Representative Fuel Cell Generation Profile (PG&E) A-19

Figure A-10: Approximate SOFC Cost Structure..... A-21

Figure A-11: Growth Data for Residential Fuel Cells..... A-23

Figure A-12: Learning Curve for Fuel Cell Energy Systems..... A-24

Figure A-13: Growth Data for Non-Residential Fuel Cell Systems A-24

Figure A-14: Effect of Learning Curves on Fuel Cell Capital Costs..... A-25

Figure A-15: Simple Schematic of a Gas Turbine System A-26

Figure A-16: Solar Turbines Saturn 20 Model, Available Power Graph A-29

Figure A-17: Kawasaki GPB15/30 Models, Available Power Graph..... A-29

Figure A-18: Degradation Factor versus Operation Hours A-30

Figure A-19: Representative Gas Turbine Generator Profile (SCG: Occupancy Application) A-33

Figure A-20: Representative Gas Turbine Generator Profile (SCG: Process Application) A-34

Figure A-21: Worldwide Production (MW) per Year for Small Gas Turbines (2006-2008)..... A-38

Figure A-22: Learning Curves for Gas Turbines..... A-39

Figure A-23: Combined Heat and Power System..... A-40

Figure A-24: Power Generation by Size in SGIP..... A-42

Figure A-25: Power Generation Worldwide and in SGIP..... A-42

Figure A-26: Efficiency Versus Part Load for IC Engines..... A-45

Figure A-27: Representative IC Engine Generator Profile (SCG: Occupancy Application) A-48

Figure A-28: Representative IC Engine Generator Profile (PG&E: Occupancy Application) A-49

Figure A-29: Learning Curve for IC Engine Systems (2008 to 2020) A-52

Figure A-30: Simple Schematic of Microturbine-Based CHP System..... A-54

Figure A-31: C65 Net Power & Efficiency vs. Ambient Temperature at Sea LevelA-57

Figure A-32: Learning Curves for Microturbines (2008 to 2020) A-63

Figure A-33: Simplified Rankine Cycle A-64

Figure A-34: ORC Market Evolution..... A-65

Figure A-35: Cost to Generate Power as a Function of Capital Cost in \$/kW A-68

Figure A-36: Cost to Generate Power as a Function of Compressor Operating Hours A-68

Figure A-37: Learning Curve for ORC Modules (European Market)..... A-70

Figure A-38: Wind Turbine Components..... A-71

Figure A-39: Scale of Wind Turbines..... A-73

Figure A-40: Trends in Installed Project and Turbine Unit Cost per Kilowatt of Rated Capacity..... A-79

Figure A-41: Wind Turbine O&M Costs over Time A-81

Figure A-42: Proportions of Lifetime Parts Costs A-82

Figure A-43: Recent Trends in Cost of Metal Inputs to Industry A-85

Figure A-44: Energy Storage Technology Landscape..... A-88

Figure A-45: Installed Capacity and Capital Costs for Li-ion A-90

List of Tables

Table 3-1: Benefits for the Cost-Effectiveness Tests.....3-2

Table 3-2: SGIPce Technology Operations Attributes.....3-4

Table 3-3: Non-Core Gas Rates Over Time 2010-39 (Nominal \$/Therm)3-5

Table 3-4: Electrical IOU Rates 2010-2039 (Nominal \$/kWh)3-6

Table 3-5: E3 CO₂ Emission Values 2010–2039 (Nominal \$ Per Ton of CO₂).....3-7

Table 3-6: SGIPce Technology Air Emissions.....3-8

Table 3-7: SGIPce Technology Progress Ratios and Capital Costs Over Time
(Nominal \$/kW)3-11

Table 3-8: SGIPce Technology Incentives (\$/kW).....3-13

Table 3-9: Technology ITC Percent and Depreciation Term3-15

Table 3-10: Costs for the Cost-Effectiveness Tests3-16

Table 3-11: Summary of Departing Load Exemption by Technology3-18

Table 5-1: Statewide Summary of Commercial Sector Societal TRC Results for
2010 and 2016, No Incentives.....5-3

Table 5-2: STRC Test Levelized Cost and Benefits for Non-combustible DG
Technologies, PG&E Territory, No Rebate, 2010.....5-6

Table 5-3: STRC Test Levelized Costs and Benefits for Natural Gas
Technologies, PG&E Territory, No Rebate, 2010.....5-10

Table 5-4: STRC Test Levelized Costs and Benefits for Directed Biogas
Technologies, PG&E Territory, No Rebate, 2010.....5-14

Table 5-5: STRC Test Levelized Costs and Benefits for On-site Biogas
Technologies, PG&E Territory, No Rebate, 2010.....5-17

Table 5-6: STRC Test Levelized Costs and Benefits for IC Engines, PG&E,
Inland, No Rebate, 20105-21

Table 5-7: STRC Test Levelized Costs and Benefits for Fuel Cells, PG&E,
Inland, No Rebate, 20105-24

Table 5-8: STRC Test Levelized Costs and Benefits for Microturbines, PG&E,
Inland, No Rebate, 20105-26

Table 5-9: STRC Test Levelized Costs and Benefits for Gas Turbines, PG&E, Inland, No Rebate, 2010 5-28

Table 5-10: Statewide Summary of Commercial Sector PCT Results for 2010 and 2016, No Incentives 5-31

Table 5-11: Statewide Summary of Commercial Sector Societal TRC Results for 2016 and PCT Results for 2010, No Incentives 5-65

Table 5-12: Statewide Summary of Commercial Sector PA Test Results for 2010 and 2016 5-67

Table A-1: Technology Inputs Used to Calculate Required Biogas Flow Rate.... A-10

Table A-2: Estimated Capital and O&M Costs of Biogas Capture for DG Technologies..... A-11

Table A-3: Estimated Total Biogas Clean Up Costs by DG Technology A-11

Table A-4: Estimated Levelized Biogas Costs..... A-12

Table A-5: Summary of SGIP Fuel Cell Characteristics as of 12/31/2009..... A-15

Table A-6: Non-Residential Fuel Cell Efficiencies from Vendor Specifications ... A-15

Table A-7: Measured Fuel Cell Electric Conversion Efficiencies (SGIP: 2008-09)A-17

Table A-8: Waste Heat Recovery from SGIP Fuel Cells (2009) A-17

Table A-9: Air Pollution Emissions Data..... A-18

Table A-10: Fuel Cell Capital Costs A-20

Table A-11: Estimated Fuel Cell O&M Costs A-22

Table A-12: Results of Learning Curve Data on Fuel Cell Costs..... A-25

Table A-13: List of Gas Turbine Manufacturers Commonly Represented in SGIPA-27

Table A-14: Summary of SGIP Gas Turbine Characteristics as of 12/31/2009... A-27

Table A-15: Electrical Efficiencies of Gas Turbines as Measured in the SGIP (2008-09)..... A-30

Table A-16: Useful Waste Heat Recovery from SGIP Gas Turbines (2009) A-31

Table A-17: Emissions for 1 MW and 5 MW Systems A-32

Table A-18: Capital Costs for Basic Installation Gas Turbines (2007 Pricing)..... A-35

Table A-19: SGIP Pricing vs. US EPA Catalog Pricing (\$/kW)..... A-36

Table A-20: Non-Fuel O&M Costs..... A-37

Table A-21: Annual Sales of Gas Turbines A-39

Table A-22: Summary of SGIP IC Engine Characteristics as of 12/31/2009 A-41

Table A-23: Performance Characteristics of Four Representative IC Engine Systems A-44

Table A-24: Electrical Efficiencies of IC Engines as Measured in the SGIP (2008-09)..... A-45

Table A-25: Useful Waste Heat Recovery from SGIP IC Engine Systems (2009)A-46

Table A-26: Typical Emission Characteristics of IC Engine Systems A-47

Table A-27: Typical NOx Emissions for IC Engine Systems A-47

Table A-28: Typical IC Engine System Capital Costs in California..... A-50

Table A-29: Typical Capital Cost for IC Engine Systems in the U.S..... A-51

Table A-30: O&M Costs for IC Engine Systems A-51

Table A-31: IC Engine Generation and CHP Capacity A-53

Table A-32: List of Microturbine Manufacturers..... A-55

Table A-33: Summary of SGIP Microturbine Characteristics as of 12/31/2009 A-56

Table A-34: Useful Waste Heat Recovery from SGIP Microturbine Systems (2009)..... A-58

Table A-35: Microturbine Emissions Characteristics A-58

Table A-36: Levelized Microturbine Equipment Costs..... A-59

Table A-37: Weighted Average Install Costs for Microturbines Installed in the SGIP A-60

Table A-38: Typical Microturbine Maintenance Costs* A-61

Table A-39: Summary of Microturbines Installed Capacity and Cost (Adapted from Capstone Annual Financial Reports)..... A-62

Table A-40: Estimated ORC Capital Costs..... A-67

Table A-41: ORC System Operating Costs A-69

Table A-42: Size Distribution on Number of Turbines Installed in United States. A-74

Table A-43: Wind Turbine Installation Element Unit Costs (\$/kW) A-77

Table A-44: Progress Ratios for Wind Energy Published in the Literature A-84

Table A-45: Li-ion Capital Costs..... A-89

1

Executive Summary

In August 2009, the California Public Utilities Commission (CPUC) adopted a cost-benefit methodology for evaluating distributed generation. In the final decision adopting the methodology, the Energy Division was directed to hire an independent entity to perform a cost-benefit analysis of the Self-Generation Incentive Program (SGIP) and California Solar Initiative (CSI) using the methodology adopted in the decision.¹ The purpose of this study is to evaluate the cost-effectiveness of distributed generation (DG) technologies using an economic model based on the adopted cost-benefit methodology. Results from the cost-effectiveness evaluation provide the framework and model to help the CPUC in identifying DG technologies eligible for the SGIP.²

In accordance with the adopted decision, DG cost-effectiveness is examined from three perspectives: society, participants, and Program Administrators.³ These perspectives are based on cost tests originally developed for evaluating cost-effectiveness of energy efficiency technologies, as outlined in the CPUC's Standard Practice Manual. The CPUC's 2009 adopted methodology modifies the cost tests so they can be used for evaluating DG technologies.

The societal version of the Total Resource Cost (STRC) test looks at the overall cost-effectiveness of DG technologies to society. Societal test results are examined at the current time (2010) and at 2016 (when the SGIP is designated to expire). The CPUC has directed that only DG technologies in which the societal benefits outweigh societal costs will be eligible for SGIP incentives. The Participant Cost test (PCT) examines the cost-effectiveness of the DG technology to the participant. If costs outweigh benefits, the technology is not cost-effective to the participant. The PCT can be used to help design an approach on incentives to be paid to the participant. The Program Administrator (PA) Cost test identifies the cost-effectiveness of DG technologies to the PAs.

¹ California Public Utilities Commission, Decision 09-08-026, August 2009, pg. 4 from http://docs.cpuc.ca.gov/word_pdf/FINAL_DECISION/105926.pdf

² CPUC, "Self-Generation Incentive Program (SGIP) Staff Proposal," September 2010.

³ The CPUC specifically excludes use of the Ratepayer Impact Measure (RIM) test in evaluating the cost-effectiveness of DG technologies in its decision (see D.09-08-026, pg. 25).

DG technologies evaluated in this study include technologies currently eligible under the SGIP or that have been eligible in the past under the SGIP, as well as technologies the CPUC requested be evaluated. As such, evaluated DG technologies include 25 different configurations of wind turbines; fossil-fueled as well as biogas-fueled⁴ internal combustion (IC) engines, microturbines, small-scale gas turbines, and fuel cells; Organic Rankine Cycle (ORC) systems; and electrical storage systems.⁵

The SGIP cost-effectiveness model (called SGIPce) developed in this study for evaluating cost-effectiveness of DG technologies is based on a variety of interwoven DG technology performance, cost, financial, and environmental information. In evaluating the cost-effectiveness of DG technologies, it became evident that interactions between these different components prevent “easy to see” patterns, especially within the Participant Cost test. Combinations of graphs and tables that identify cost and benefit components are presented in the Results section of this study to help identify the underlying reasons behind the results. In addition, the SGIPce model allows users to change inputs into the model to “test” different assumptions and better understand critical factors leading to the cost-effectiveness results.

Results of the STRC test show that nearly all of the evaluated DG technologies are cost-effective to society at either 2010 or 2016 given the input assumptions used in the Base Scenario. Exceptions include medium or large storage, and gas turbines in the 1,000 kW size range fueled by natural gas, directed biogas or on-site biogas. To review more of the results in detail for the STRC please see Section 5, pages 5-1 through 5-29. We have provided a summary of the 2016 results below as Figure 1-1.

⁴ Biogas refers to gas produced from the biological breakdown of organic matter occurring in landfills, wastewater treatment facilities, food processing plants and ponds (or lagoons) that store animal wastes.

⁵ Solar photovoltaic (PV) systems were not evaluated in this study because they were examined under the CSI cost-effectiveness study by Energy and Environmental Economics (E3).

Figure 1-1: Statewide Societal Total Resource Cost

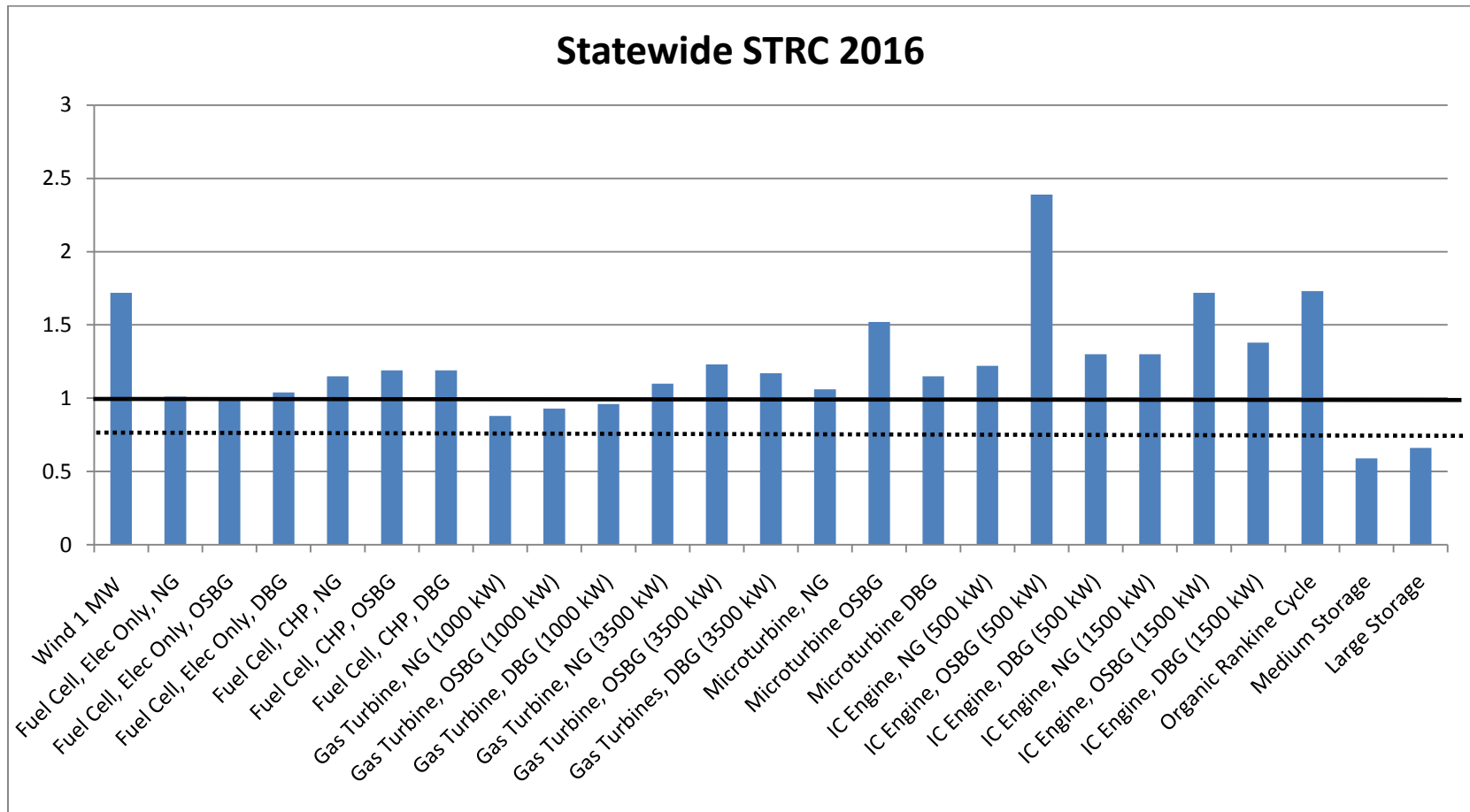

NG = Natural Gas; OSBG = On-site Biogas; DBG = Directed Biogas; CHP = Combined Heat and Power

The SGIPce model generates PCT results by DG technology, electric IOU territory, sector (e.g., commercial, residential, or government/non-profit) and geographical region (“coastal” and “inland”). Please see Section 5 for a comprehensive list of results and Figure 1-2 below for the 2010 results for the technologies without an incentive. Key findings of the PCTs modeled without an incentive include the following:

- The PCT results are always higher for PG&E and SCE than for SDG&E. SDG&E’s electrical rates are lower than PG&E and SCE for the commercial sector so the avoided bill benefit is lower for SDG&E.
- IC engines (1,500 kW) fueled by on-site biogas has the highest PCT value of any commercial system analyzed under the Base Scenario without incentives. The PCT is 1.81 for PG&E, 1.82 for SCE, and 1.54 for SDG&E. Note that IC engines (1,500 kW) fueled by on-site biogas also have a relatively high STRC. The STRC for IC engines (1,500 kW) is 1.5 in 2010 and 1.74 in 2016 for the statewide electricity weighted results.
- Wind and ORC pass the PCT for all three utilities without incentives. These two technologies also pass the STRC for all three utilities.
- IC engines (500 kW) have a PCT greater than 1.0 for natural gas, on-site biogas, and directed biogas-fueled systems without an incentive for PG&E and SCE. Natural gas and on-site biogas systems have PCT values of nearly 1.0 for SDG&E.
- Both electric-only fuel cells and fuel cells using waste heat recovery pass or nearly pass the PCT without an incentive when fueled by on-site biogas. The PCT values for systems fueled by natural gas and directed biogas are slightly lower, though still over 0.90 for PG&E and SCE.
- Gas turbines in the 2-5 MW range (modeled as 3.5 MW) pass the PCT when fueled by on-site biogas for all three utilities without an incentive. Gas turbines in this range also pass the PCT when fueled by natural gas in PG&E and SCE territory.
- Gas turbines in the less than 2 MW range (modeled as 1 MW) pass the PCT when fueled by on-site biogas for PG&E and SCE.
- Microturbines, regardless of fuel type, fail to pass the PCT without an incentive, but are very close to passing the test when fueled by natural gas, rather than on-site biogas or directed biogas.
- Storage fails to pass the PCT without an incentive by a wide margin for all utilities.

Figure 1-2: Statewide PCT Without an Incentive

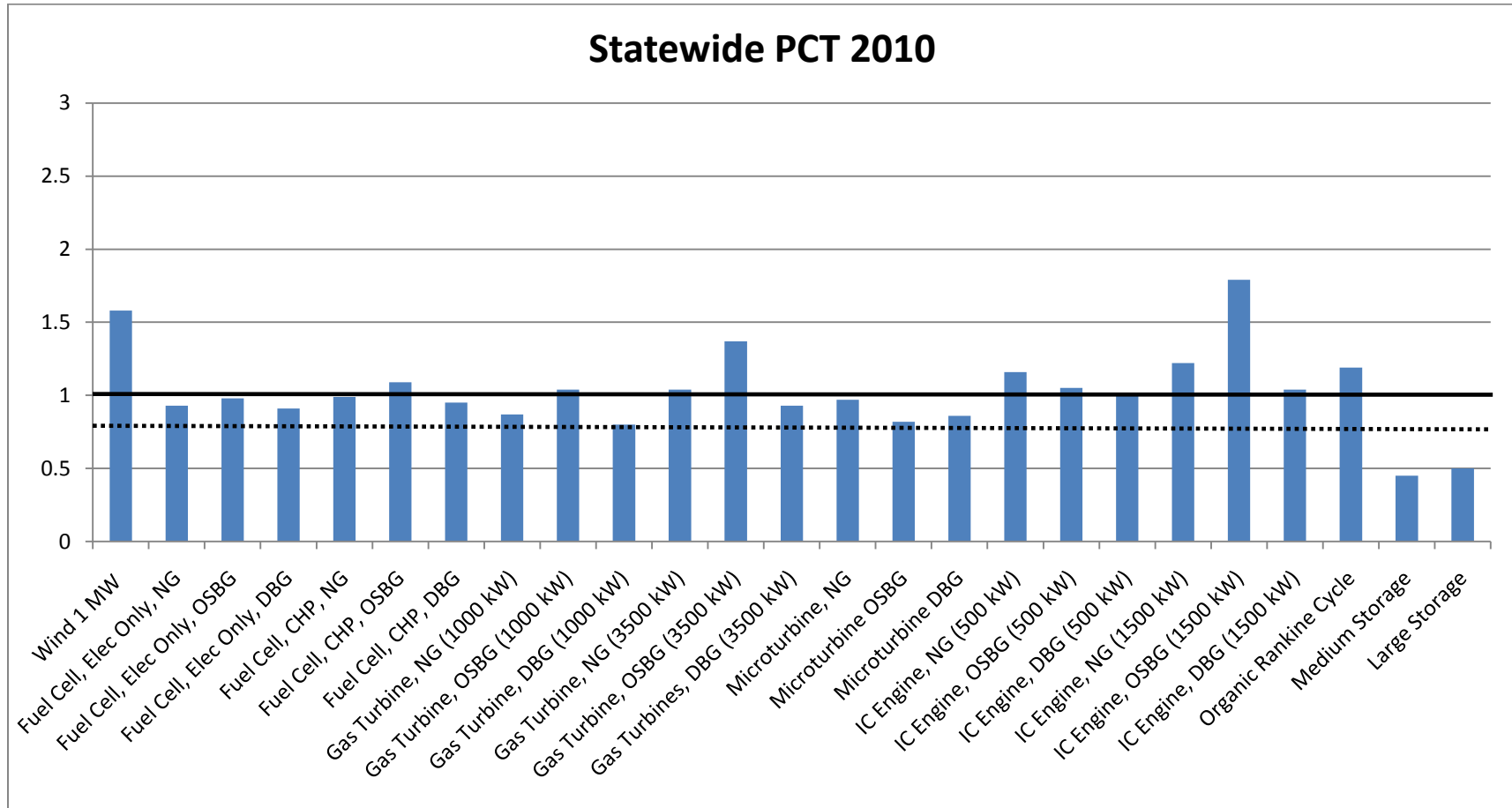

NG = Natural Gas; OSBG = On-site Biogas; DBG = Directed Biogas; CHP = Combined Heat and Power

To better understand how incentive levels may affect DG technologies, the study also examines the relationship between modified internal rates of return (MIRR) and incentive levels. The MIRR represents a financial evaluation of an investment's attractiveness and can be used to rank alternative investments. A higher MIRR value reflects a more attractive investment. Each IOU-specific PCT benefit-to-cost ratio has an associated MIRR value. Results for PG&E are provided in Section 5, and results for all of the IOUs are provided in Appendix C. In general, analyses of the MIRR show the following:

- For DG technologies that pass the PCT, the IOU-specific MIRR values fall between 10.3% and 17.4%.
- Generally, the MIRR values for DG technologies passing the PCT fall either in 10-11.9% range or 14+%. Very few of the systems with PCT greater than 1.0 have MIRR values from 12-13.9%.

The report is organized in the following manner:

- **Section 1:** This Executive Summary.
- **Section 2:** An introduction and background to DG technologies in California and the CPUC ruling on DG cost-effectiveness.
- **Section 3:** The critical inputs and assumptions used in the model and the study.
- **Section 4:** The modeling methodology and approach.
- **Section 5:** The results from the SGIPce model.
- **Appendix A:** Information on the costs and performance of DG technologies examined in this study.
- **Appendix B:** The SGIPce model user guide.
- **Appendix C:** Output of results for all the different combinations of DG technologies by utility, location, and sector.

2

Introduction and Background

2.1 Distributed Generation Resources in California

2.1.1 Defining Distributed Generation

The definition of what constitutes a distributed generation (DG) resource has evolved over time. Generally, DG resources are considered to be “small scale electric generating technologies installed at, or in close proximity to, the end-user's location.”¹ Functionally, DG facilities are interconnected on the distribution system side of the electricity system rather than at the transmission side. DG systems tend to be sized to displace electricity demand for the end user, but can include occasional export of electricity to the grid. Common DG technologies include solar photovoltaic (PV) systems, small-scale wind turbines, fossil-fueled as well as biogas-fueled² internal combustion (IC) engines, microturbines, small-scale gas turbines, and fuel cells.

2.1.2 Historical and Current Status of DG in California

Due to changes in DG definitions, it is difficult to clearly identify how much growth has occurred in DG systems in California over the past two decades. Estimates of DG systems installed and currently operating in California range from 900 MW to over 8,000 MW.³ Nonetheless, California energy policies have unmistakably indicated interest in continued development of DG resources. The Joint Agency Energy Action Plan, first adopted on May 8, 2003,⁴ identifies DG as a preferred resource in the Loading Order. In 2007, the California Energy Commission (CEC) set a goal for DG and cogeneration resources to help meet 25% of California's peak electricity needs by 2020.⁵ Similarly, the 2009 Integrated Energy Policy Report identifies the need for expansion of DG resources in order to help address greenhouse gas

¹ California Public Utilities Commission Decision (D.)99-10-065, 1999.

² Biogas refers to gas produced from the biological breakdown of organic matter occurring in landfills, wastewater treatment facilities, food processing plants and ponds (or lagoons) that store animal wastes.

³ Itron, Inc., *Impacts of Distributed Generation*, prepared for the California Public Utilities Commission, January 2010, pgs. 3-6 to 3-9.

⁴ State of California Energy Action Plan, adopted, May 8, 2003, pg. 2.

⁵ California Energy Commission, *Distributed Generation and Cogeneration Policy Roadmap for California*, CEC-500-2007-021, March 2007, pg. 3.

(GHG) reduction goals.⁶ This statewide commitment to continued growth in DG resources is also reflected in California's Clean Energy Future. Developed jointly by the California Public Utilities Commission (CPUC), the CEC, the California Environmental Protection Agency (CalEPA), and the California Independent System Operator Corporation (CAISO), this report targets deployment of 5,000 MW of new renewable DG statewide by 2020 at the right locations on the power grid to support reliability and provide economic value.⁷

Renewable DG resources are also likely to play a strong role in meeting California's Renewables Portfolio Standard (RPS). In 2009, California established an RPS goal via the Governor's Executive Order dictating that California's electrical utilities procure 33% of their electricity needs from renewable resources by 2020.⁸ A recent study on implementation of the 33% RPS has indicated that significant growth in renewable DG resources may be needed if the state is to meet the goal.⁹

California's commitment to future growth in DG is also reflected in state incentive programs that are using ratepayer monies to develop DG resources within California. Two notable efforts are the Self-Generation Incentive Program (SGIP) and the California Solar Initiative (CSI). Established in 2001, the SGIP has provided over \$623 million in California ratepayer funds to help install 1,343 DG projects representing over 360 MW of generating capacity.¹⁰ With a 10-year budget of over \$2.1 billion, the CSI has the goal of developing 1,940 MW of new distributed solar capacity by the end of 2016.¹¹ By the end of 2010, nearly 41,000 solar PV systems accounting for over 440 MW of new solar generating capacity were installed under the CSI.¹² In addition to the SGIP and CSI, the CEC oversees the New Solar Homes Partnership (NSHP) and the Emerging Renewables Program (ERP), two complementary programs to the SGIP and CSI.

2.2 Costs and Benefits of DG Technologies

There is a wide variety of DG technologies and a commensurately broad assortment of costs and benefits. Costs generally include capital and financing costs; fuel purchases; and operating and

⁶ California Energy Commission, *2009 Integrated Energy Policy Report*, CEC-100-2009-03-CMF, December 2009, pg. 236.

⁷ <http://www.cpuc.ca.gov/PUC/energy/Climate+Change/future.htm>

⁸ Governor Schwarzenegger Executive Order (EO) S-21-09, September 15, 2009.

⁹ California Public Utilities Commission, *33% Renewables Portfolio Standard: Implementation Analysis Preliminary Results*, June 2009, pg. 2.

¹⁰ <https://energycenter.org/index.php/incentive-programs/self-generation-incentive-program/sgip-documents/sgip-documents>

¹¹ CPUC website, <http://www.cpuc.ca.gov/PUC/energy/Solar/aboutsolar.htm>, December 2010.

¹² California Solar Statistics: http://www.californiasolarstatistics.ca.gov/reports/agency_stats/

maintenance (O&M) expenses. Examples of benefits include energy and the associated bill savings (from displacement of fuel and/or electricity from the utility); tax credits; and revenues from such items as renewable energy credits (RECs) and carbon credits. Costs and benefits change over time and are affected by DG technology performance. The following sections discuss significant drivers to costs and benefits of DG technologies.

2.2.1 Drivers to DG Technology Costs

Changes in equipment costs can be a significant driver to overall DG technology costs. Equipment costs can decrease due to advancements in manufacturing processes, incorporation of less expensive materials, and more streamlined installation methods, to name a few. In general, most technologies follow a learning curve that reflects reduced capital costs as more is learned about ways to manufacture the technology. Solar PV equipment costs are a good example.

Figure 2-1 shows how PV module prices dropped between 1976 and 2005 as improvements were made in manufacturing PV modules. Similar approaches in developing learning curves can be applied to other DG technologies to help identify how capital costs may change over time.

The manner in which DG projects are financed has been undergoing changes. Traditionally, many DG projects were financed using a firm's working capital either through free cash flows from other operations or through a debt/equity arrangement to maximize the firm's return on investment. A growing trend is for project developers (through limited partnerships) to finance and own DG systems and entering into Power Purchasing Agreements with the host sites. In these instances, the investment costs have shifted from end users who have limited investment capability or ability to monetize certain tax attributes to third parties who recapture the investment through a combination of tax credits and contracted energy payments (via the power purchase agreements).

Figure 2-1: Learning Curve for PV Module Prices (1976-2005)

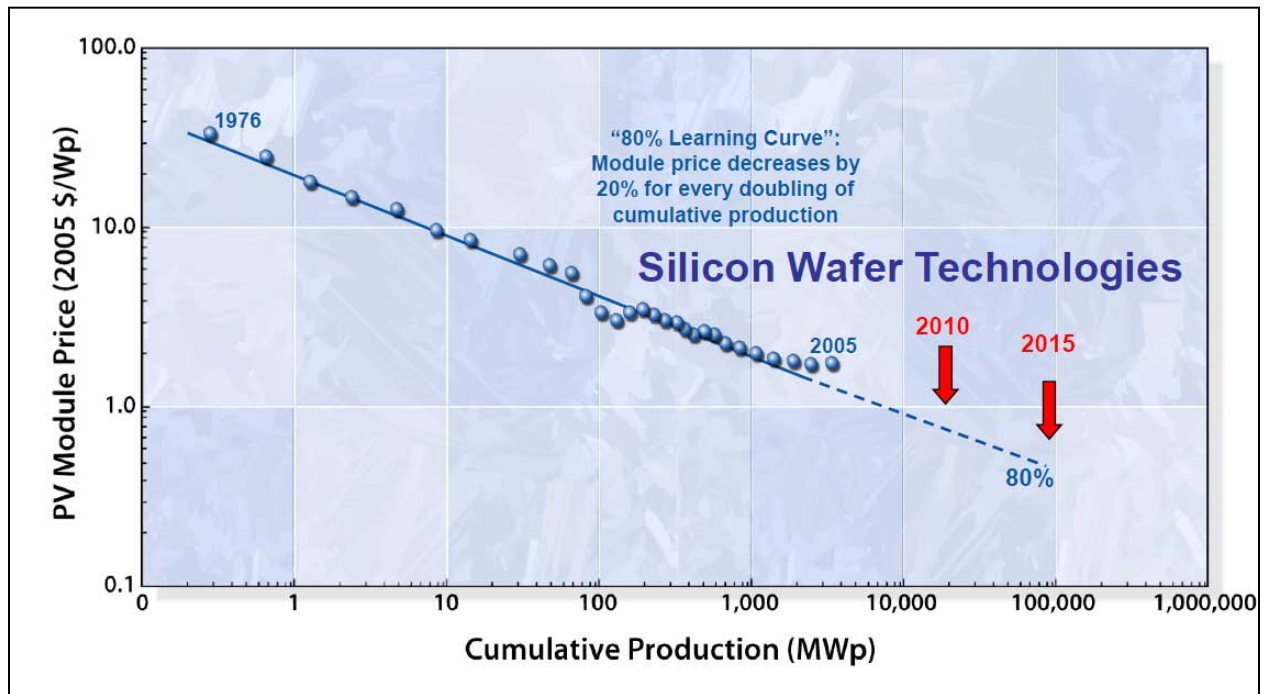

Source: Kung, Harriet, "Basis Energy Sciences," presentation at Board on Physics and Astronomy Spring Meeting, April 24, 2009 from www.science.doe.gov/bes/presentations/ppt/Kung_24APR09.ppt

Fuel costs can also strongly influence overall DG costs. Some renewable-based technologies, such as wind and solar PV, have no on-going fuel costs. DG technologies that are combustion-based employ conventional (e.g., natural gas) or renewable resources (e.g., biogas) for fuel. In the case of natural gas, costs can be volatile but historically have trended upward.¹³ For combustion-fueled technologies, the monetary value of the technology's GHG emissions influences the costs of the technology from a total resource perspective. As society has become more aware of the potential hazard associated with GHG, the monetary value or costs assigned to these emissions has trended upward.

2.2.2 Drivers to DG Technology Benefits

Bill savings can be one of the single largest benefits accruing to host sites employing DG technologies, while avoided electricity production is the single largest benefit accruing to society. For DG technologies displacing retail rate electricity, future bill savings are tied to the DG technologies continued electricity production, the technology's rate of degradation, and changes in electricity rates and rate structures.

¹³ For example, see R. Tavares, "Natural Gas Price Forecast and Uncertainty," for the Joint IEPR and Electricity and Natural Gas Committee Workshop, June 16, 2009.

http://www.energy.ca.gov/2009_energypolicy/documents/2009-06-16_workshop/presentations/01_CEC_Tavares_Natural_Gas_Price_Foreast_and_Uncertainty.pdf

For the host site there are two principal direct tax benefits associated with the installation of DG technologies: the federal investment tax credit (ITC) which varies from 10 to 30% of the cost of new equipment used to generate electricity, and the five-year Modified Accelerated Cost Recovery System (MACRS) depreciation (available for some DG technologies).¹⁴ The 30% federal ITC allows the host to reduce their federal income taxes by 30% of the cost of the measure while the shortened depreciation schedule allows them to rapidly write off the cost of the DG technology from their state and federal tax liabilities. In addition, the operating costs—including standard operation, maintenance, and fueling expenses—can have implications for the site’s state and federal tax liability, leading to smaller state and federal tax liabilities or larger refunds.

Ratepayer-funded rebates such as those in the SGIP and CSI also provide benefits to the host sites that can be used to directly reduce the equity investment required to purchase DG technologies or to reduce the debt associated with the investment. Program rebates and incentives can dramatically improve the financial return of the investment to the host.

For society, DG technologies can lead to a measurable reduction in GHG emissions. The installation of DG technologies fueled by on-site biogas at a site that was not previously undertaking methane capture leads to substantial reductions in GHG. The ability to monetize the value of the reduction in GHG helps to clearly illustrate the value of methane capture and DG technologies fueled by on-site biogas.

¹⁴ See Table 3-9 in Section 3 for a listing of the treatment of the ITC and MACRS by DG technology.

2.2.3 DG Cost-Effectiveness Project

As the contribution of DG resources increases and policy makers continue to look for ways to promote DG, it becomes increasingly important to understand the relationship between costs and benefits of DG technologies. For technologies funded through SGIP, cost-effectiveness evaluations such as this study help policy makers review how rate payers' funds are being used and contribute to the analysis of the program's success.

In late 2009, the CPUC adopted a common methodology for evaluating the cost-effectiveness of DG technologies.¹⁵ The DG cost-effectiveness methodology is derived from the Standard Practice Manual (SPM) that has been used for several decades to successfully evaluate energy efficiency technologies and programs. The DG cost-effectiveness methodology adopted by the CPUC looks at whether a DG program is cost-effective from a variety of perspectives: society, ratepayers and participants.

In 2010, the CPUC commenced oversight over two projects to look at the cost-effectiveness of existing CPUC programs. One project is designed to review the cost-effectiveness of the CSI program, and that project is applying the CPUC methodology to the CSI program. The second project, reported herein, is applying the CPUC methodology to the SGIP program. Both projects use the CPUC methodology as the framework, but rely on quantitative models to analyze all of the relevant data inputs and present summary results.

The DG cost-effectiveness tests adopted by the CPUC use a variety of variables and inputs. One important input to the models includes the avoided costs developed by Energy and Environmental Economics, Inc. (E3). These avoided costs were originally developed by E3 to apply during the cost-effectiveness reviews of energy efficiency programs. E3 also developed a set of other model inputs, such as utility rates and forecasts of those rates, financing and tax assumptions, etc. for use in the CSI cost-effectiveness model. The SGIP cost-effectiveness model (called SGIPce) incorporates work undertaken by E3, and adds to it the SGIP program-specific information. Examples of SGIP program-specific information include energy use and energy savings assumptions that are derived from SGIP rules and SGIP metered site-level data. The SGIPce model used in the evaluation of the cost-effectiveness of DG technologies applies the values of critical inputs and the various cost-effectiveness equations to calculate an estimate of the current and future cost-effectiveness of DG technologies in California from the three alternative perspectives. The SGIPce model also includes possible market transformation effects of the SGIP program on the future costs of the technology, thereby enabling the model to project cost-effectiveness on a prospective and not just retrospective basis.

¹⁵ California Public Utilities Commission, Decision 09-08-026, August 2009 from http://docs.cpuc.ca.gov/word_pdf/FINAL_DECISION/105926.pdf

There are two goals to this cost-effectiveness evaluation: 1) help identify those DG technologies whose societal benefits are close to or exceed their societal costs; and 2) review how the relationship between these benefits and costs is forecast to develop over time. Societal cost/benefit evaluation helps to ensure that ratepayer dollars for rebates are used effectively and efficiently. Although actual cost-effectiveness for each DG project is truly site-specific, an overall participant cost/benefit analysis can help the CPUC and program administrators design appropriate rebate levels and program rules.

As noted above, cost-effectiveness evaluations review costs and benefits from a variety of perspectives, depending on who is paying and who is benefiting. For example, capital investment in a DG technology is considered to be a cost in the Total Resource Cost Test (TRC or TRC Test), the Societal Total Resource Cost Test (STRC or STRC Test), and the Participant Cost Test (PCT) but not in the Program Administrator Test (PA Test). Rebates received are a benefit within the PCT and rebates paid are a cost in the PA Test. Rebates are a transfer payment within the TRC and the STRC and therefore do not have a first order impact on the test value.¹⁶ The monetary value of a cost or a benefit will also depend on the test that is being evaluated. Within the TRC and the STRC the benefit of the avoided electricity production is valued at the avoided costs while these benefits are valued at the bill rate within the PCT.

The cost-effectiveness methodology employed in this report clearly describes the benefits and the costs of DG technologies from the perspectives of society, the participant, and the utility. The report presents the critical inputs to the alternative cost-effectiveness tests, including a full description of the inputs, information on how the values of the inputs were developed, and tables illustrating the input values. In addition, the report outlines the mathematical equations undertaken to calculate the various cost-effectiveness tests, with a description of the critical inputs that contribute to each test.

¹⁶ The taxable nature of rebates and the CPUC's decision to incorporate federal income tax benefits into the calculation of the TRC leads program rebates to have a second order impact on the TRC and the STRC. If tax effects are not incorporated into these tests, rebates do not impact the calculation of the TRC or the STRC.

3

Critical Inputs, Assumptions, and Cost-Effectiveness Methodology

3.1 Critical Inputs and Assumptions

The Self-Generation Incentive Program Cost-Effectiveness (SGIPce) model has a number of inputs by technology (e.g., capital costs) as well as global constants (e.g., interest rates) that are applied to each technology and that impact the benefits and costs of the technologies. The inputs used in SGIPce are listed in Attachment A of CPUC Decision (D.) 09-08-026.¹

The DG cost-effectiveness evaluation and SGIPce model analyzed DG technologies using four cost-effectiveness tests: the Participant Test (PCT), the Total Resource Test (TRC), the Societal Total Resource Test (STRC), and the Program Administrator Cost Test (PA). The evaluated technologies and key assumptions were identified in concert with the CPUC. The technologies examined are those currently eligible in the SGIP, technologies formerly included in SGIP, and additional technologies that the CPUC identified as possible candidates for future SGIP technologies. Possible candidates for future SGIP technologies were based on input of parties from workshops and comments from the CPUC's DG Rulemaking (R.)10-05-004.

Later sections of this report show the model results based on a standardized set of run assumptions. The SGIPce model has been available for download to the public since November 2010. The application is dynamic, enabling stakeholders to modify the model and make model runs using alternative assumptions. That model is located on the CPUC website: http://www.cpuc.ca.gov/PUC/energy/DistGen/sgip/proposal_workshops.htm.

3.1.1 Critical Inputs—Benefits

Table 3-1 lists the benefits for the various cost-effectiveness tests as outlined in Attachment A of D.09-08-026. The table is followed by a section describing the source of the data and critical assumptions made by the evaluation team.

¹ http://docs.cpuc.ca.gov/word_pdf/FINAL_DECISION/105928.pdf

Table 3-1: Benefits for the Cost-Effectiveness Tests

Benefit	PCT	TRC	STRC	PA
Avoided line losses	NA	Included	Included	Included
Avoided purchase of energy commodity and resource adequacy costs	NA	Included	Included	Included
Avoided transmission and distribution (T&D) costs (T&D investment deferrals)	NA	Included	Included	Included
Combined heat and power (CHP) plant-specific benefits	Included	Included	Included	NA
CHP gas and electric bill savings	Included	NA	NA	NA
Environmental benefits (CO ₂ , NO _x , and particulate matter emissions)	NA	Included*	Included	Included
Market transformation effects	Included	Included	Included	NA
Net energy metering bill credits	Not Included	NA	NA	NA
Rebates/Incentives	Included and can be run with and w/out rebates	NA	NA	NA
Reduced electricity bills	Included	NA	NA	NA
Reliability benefits (both system and customer ancillary services/VAR support)	Not included in SGIPce model	Included	Included	Included
Standby charge exemption	Included	NA	NA	NA
Tax credits/depreciation	Included	Included	Included	NA
Utility interconnection not charged to DG customer	Not included in SGIPce model	NA	NA	NA

* Environmental benefits are included in both the TRC and the STRC in California DSM cost-effectiveness evaluations.

Avoided Line Losses, Purchase of Energy Commodity, and T&D Costs

DG systems generate electricity that can be used in lieu of power supplied from the grid. Consequently, these benefits are associated with electricity purchases avoided from central station power plants and instead supplied from DG systems. Benefits from avoided line losses are due to DG systems reducing the need for transmission of electricity from central station power plants and the commensurate line losses associated with electricity transmission. These benefits are included as part of the E3 avoided cost model and are utility- and TOU period-specific.

The avoided purchase of energy commodities and resource adequacy costs are comprised of an 8,760 hours per year stream of avoided electricity purchases and monthly values for the avoided gas purchases. The avoided electricity and gas costs were obtained from the E3 electric and gas avoided cost model. Finally, avoided transmission and distribution (T&D) costs are the T&D costs that were avoided due to having local generation. These were also obtained from the E3 electric and gas avoided cost model.

CHP Plant-Specific Benefits and CHP Gas and Electric Bill Savings

These benefits are a result of waste heat captured from the DG electricity generation system which is then used on-site. While the heat may be used to replace electricity or natural gas consumption, the model and the inputs used in the evaluation assumed that the heat is used as a replacement for gas that would have been used for heating water for a boiler. The efficiency of the boiler for this calculation was assumed to be 80%. Table 3-2 is a listing of the different electrical efficiencies, waste heat utilization, and capacity factors used in the SGIPce model for the different DG technologies. These data were derived from metered SGIP facility data, the SGIP Impact Evaluation reports, equipment fact sheets, and other sources.

The technology-specific capacity factors used in the Base Scenario are a combination of 8,760 hours per year load profiles from actual metered SGIP sites. The observed load profiles were then mathematically adjusted such that all technologies have an average annual capacity factor of approximately 80% but have a load shape that is representative of the DG technology. The 80% annual capacity factor was requested by the CPUC as being a minimum requirement for future DG technologies under the SGIP. It is important to note that the CPUC cost-effectiveness financial and greenhouse gas (GHG) models are based on a prescribed 80% capacity factor versus an observed capacity factor. Observed annual capacity factors for different DG technologies were often significantly lower than 80%. However, industry comments indicated that DG technologies should be operating at 80% or higher annual capacity factors. In addition, use of the lower observed capacity factors would lead to lower performance and commensurately lower cost-effectiveness of DG technologies.

If required, the SGIPce model allows the user to chose to use the actual load profiles and capacity factors which vary from approximately 30% to 90% or to adjust the capacity factor while maintaining a given load profile shape. This functionality enables the CPUC or other interested parties to examine the sensitivity of the cost-effectiveness results to alternative assumptions concerning the DG technology capacity factors.²

² Section 9 of Appendix B describes how to adjust input values, including the capacity factor, within the SGIPce model.

Table 3-2: SGIPce Technology Operations Attributes

Technology	Fuel	Capacity Factor	Electrical Efficiency	Waste Heat Utilization (Therm/kWh)	Degradation Factor per Year	O&M (\$/kWh)
FC1200kWe	DIRBGas	0.80	0.50	0	0.01	\$0.0300
FC1200kWe	NG	0.80	0.50	0	0.01	\$0.0300
FC1200kWe	OSBGas	0.80	0.50	0	0.01	\$0.0619
FC1200kW	DIRBGas	0.80	0.46	1,840	0.01	\$0.0300
FC1200kW	NG	0.80	0.46	1,840	0.01	\$0.0300
FC1200kW	OSBGas	0.80	0.46	1,840	0.01	\$0.0619
GTg2to5MW	DIRBGas	0.80	0.32	2,790	0.01	\$0.0174
GTg2to5MW	NG	0.80	0.32	2,790	0.01	\$0.0174
GTg2to5MW	OSBGas	0.80	0.32	2,790	0.01	\$0.0485
GTle2MW	DIRBGas	0.80	0.24	2,790	0.01	\$0.0211
GTle2MW	NG	0.80	0.24	2,790	0.01	\$0.0211
GTle2MW	OSBGas	0.80	0.24	2,790	0.01	\$0.0670
ICE1500kW	DIRBGas	0.80	0.33	3,190	0.01	\$0.0069
ICE1500kW	NG	0.80	0.33	3,190	0.01	\$0.0069
ICE1500kW	OSBGas	0.80	0.33	3,190	0.01	\$0.0348
ICE500kW	DIRBGas	0.80	0.33	3,190	0.01	\$0.0121
ICE500kW	NG	0.80	0.33	3,190	0.01	\$0.0121
ICE500kW	OSBGas	0.80	0.33	3,190	0.01	\$0.0492
MT200kW	DIRBGas	0.80	0.24	5,890	0.01	\$0.0200
MT200kW	NG	0.80	0.24	5,890	0.01	\$0.0200
MT200kW	OSBGas	0.80	0.24	5,890	0.01	\$0.0947
ORC500kW	NA	0.80	0.15	0	0.01	\$0.0070
Storage1MW	NA	0.17	0.00	0	0.00	\$0.0430
Storage25kW	NA	0.17	0.00	0	0.00	\$0.0694
WD1MW	NA	0.29	1.00	0	0.01	\$0.0080

Note: The technology abbreviations and other terms are defined at the beginning of this report. The O&M values are in 2010 dollars.

SGIP metered data also provide information on the actual amount of useful waste heat recovery that has been observed within the SGIP for different DG technologies. However, like the annual capacity factor, waste heat utilization was modified to account for a minimum system efficiency prescribed by the CPUC. The waste heat utilization factors employed in the model were derived by setting the overall efficiency of the system to 60% and determining the amount of waste heat used based on the observed electrical efficiency.³ Based on this approach and the boiler efficiency, the SGIPce model determines the amount of gas use that is offset from waste heat captured from the CHP system. The evaluation team used the non-core gas commercial rates to monetize this benefit in the PCT. The wholesale gas forecast is based on the 2009 market price referent (MPR) and is from the E3 gas avoided cost workbook developed for DG program evaluation. These rates are provided below in Table 3-3. For the TRC and STRC, the gas-saving benefits were valued using the commodity value of the E3 gas avoided cost model.

Table 3-3: Non-Core Gas Rates Over Time 2010-39⁴ (Nominal \$/Therm)

Year	2010	2011	2012	2013	2014	2015	2016	2017	2018	2019
Gas Price	\$5.47	\$6.13	\$6.55	\$6.83	\$7.12	\$7.41	\$7.70	\$8.00	\$8.30	\$8.55
Year	2020	2021	2022	2023	2024	2025	2026	2027	2028	2029
Gas Price	\$8.77	\$9.00	\$9.08	\$9.16	\$9.30	\$9.78	\$10.29	\$10.72	\$11.12	\$11.50
Year	2030	2031	2032	2033	2034	2035	2036	2037	2038	2039
Gas Price	\$11.94	\$12.31	\$12.72	\$13.13	\$13.54	\$13.95	\$14.36	\$14.78	\$15.20	\$15.62

Avoided gas and electrical bill savings for the CHP facility were derived by DG technology based on the above electrical efficiencies, waste heat utilization, and capacity factors. For each technology an annual estimate of gas savings (i.e., therms) and avoided electricity utility purchases (i.e., kWh) was derived and multiplied by the prevailing non-core gas rate or appropriate electrical rate based on the utility-specific location of the CHP facility. The gas rates used in the model are shown above in Table 3-3. Two electric rates for each utility are available in the SGIPce model. The model uses 8,760 hours per year of electricity production and the electricity rate to calculate a production-weighted average yearly cost of electricity.

³ The approach and resulting waste heat utilization factors are described in Appendix A. Note that for the 1200 kW electric-only fuel cell, there is no utilized waste heat.

⁴ Gas forecast from 2010 to 2040 based on 2009 Market Price Referent (MPR) update. <http://www.cpuc.ca.gov/PUC/energy/Renewables/mpr.htm>. The forecast is in nominal dollars and assumes a 2% inflation rate.

Table 3-4 lists the average yearly cost of electricity. These rates over time were increased using the CEC’s California Energy Demand Forecast.⁵ The rates start in 2010 dollars but are nominal, assuming a 2% inflation rate.

Table 3-4: Electrical IOU Rates 2010-2039 (Nominal \$/kWh)

IOU	RATE	2010	2011	2012	2013	2014	2015	2016	2017	2018	2019
SCE	GS2TOU	\$0.140	\$0.144	\$0.148	\$0.152	\$0.157	\$0.162	\$0.168	\$0.175	\$0.181	\$0.188
PG&E	A10TOU	\$0.134	\$0.138	\$0.142	\$0.146	\$0.151	\$0.155	\$0.161	\$0.168	\$0.174	\$0.181
SDG&E	A6TOU	\$0.110	\$0.113	\$0.117	\$0.120	\$0.124	\$0.127	\$0.132	\$0.137	\$0.143	\$0.148
IOU	RATE	2020	2021	2022	2023	2024	2025	2026	2027	2028	2029
SCE	GS2TOU	\$0.196	\$0.203	\$0.211	\$0.219	\$0.228	\$0.236	\$0.246	\$0.255	\$0.265	\$0.275
PG&E	A10TOU	\$0.188	\$0.195	\$0.203	\$0.210	\$0.219	\$0.227	\$0.236	\$0.245	\$0.255	\$0.264
SDG&E	A6TOU	\$0.154	\$0.160	\$0.166	\$0.173	\$0.179	\$0.186	\$0.193	\$0.201	\$0.209	\$0.217
IOU	RATE	2030	2031	2032	2033	2034	2035	2036	2037	2038	2039
SCE	GS2TOU	\$0.286	\$0.297	\$0.309	\$0.321	\$0.333	\$0.346	\$0.359	\$0.373	\$0.388	\$0.403
PG&E	A10TOU	\$0.275	\$0.285	\$0.296	\$0.308	\$0.320	\$0.332	\$0.345	\$0.358	\$0.372	\$0.387
SDG&E	A6TOU	\$0.225	\$0.234	\$0.243	\$0.252	\$0.262	\$0.272	\$0.283	\$0.294	\$0.305	\$0.317

Other benefits include the value of renewable energy credits (RECs) for those technologies fueled by a renewable fuel (e.g., wind, on-site biogas and directed biogas). The value of the REC for electricity generated using a renewable fuel in the SGIPce model is \$0.035 per kWh. This matches the REC value used by the E3 California Solar Initiative (CSI) cost-effective model. The REC monetary benefit is included for the participant in the PCT.

⁵ <http://www.energy.ca.gov/2009publications/CEC-200-2009-012/CEC-200-2009-012-SD.PDF>

Environmental Benefits (CO₂, NO_x, and Particulate Matter Emissions)

DG systems can also provide environmental benefits by avoiding the need to generate electricity from central station power plants as well as avoiding natural gas combusted in boilers to provide thermal energy for on-site needs. The avoided environmental emissions associated with decreasing the use of electricity generated at central station plants and reducing natural gas consumption in the boiler are captured in the E3 avoided cost calculations. These benefits are applied to the TRC and the STRC. Table 3-5 lists the CO₂ emissions valuation from the E3 avoided cost workbook. The base case scenario uses avoided cost values associated with the mid-carbon price forecast while the GHG scenario uses the high level carbon forecast.

Table 3-5: E3 CO₂ Emission Values 2010–2039 (Nominal \$ Per Ton of CO₂)

Year	2010	2011	2012	2013	2014	2015	2016	2017	2018	2019
Mid Value Case of CO ₂ Emissions	\$12.72	\$13.98	\$15.37	\$16.89	\$19.87	\$22.85	\$26.05	\$29.26	\$32.70	\$36.14
High Value Case of CO ₂ Emissions	\$27.53	\$29.47	\$31.55	\$33.78	\$37.10	\$40.42	\$43.98	\$47.54	\$51.35	\$55.17
Year	2020	2021	2022	2023	2024	2025	2026	2027	2028	2029
Mid Value Case of CO ₂ Emissions	\$39.84	\$43.67	\$47.51	\$51.62	\$55.73	\$60.13	\$64.54	\$69.25	\$73.96	\$79.00
High Value Case of CO ₂ Emissions	\$59.25	\$63.47	\$67.70	\$72.21	\$76.73	\$81.55	\$86.39	\$91.53	\$96.70	\$102.19
Year	2030	2031	2032	2033	2034	2035	2036	2037	2038	2039
Mid Value Case of CO ₂ Emissions	\$84.21	\$85.89	\$87.61	\$89.36	\$91.15	\$92.97	\$94.83	\$96.73	\$98.66	\$100.63
High Value Case of CO ₂ Emissions	\$107.86	\$110.02	\$112.22	\$114.46	\$116.75	\$119.09	\$121.47	\$123.90	\$126.38	\$128.90

Additional environmental benefits are provided by DG technologies using on-site biogas at sites that did not previously participate in methane capture. For host sites installing on-site biogas-fueled DG technologies simultaneously with the implementation of methane capture, substantial reductions in CO₂ are realized.⁶

⁶ The model was set to evaluate ICE 500 kW and microturbines fueled with on-site biogas (OSBG) as sites that simultaneously implement methane capture. The other OSBG technologies are assumed to have previously captured their methane. The model can be adjusted to allow or disallow methane benefits for other OSBG technologies.

Table 3-6 is a listing of the reduced carbon emission for on-site biogas sites with methane capture (ICE 500 and MT 200) as well as the emissions for all the examined DG technologies. The reduced emission of CO₂ at on-site biogas sites is valued within the base forecast at the mid-level carbon prices available in the E3 avoided cost workbook and listed in Table 3-5.

Table 3-6: SGIPce Technology Air Emissions

Technology	Fuel	Emissions Factors - CO₂ (lbs/MWh)	Emissions Factors - NOx (lbs/MWh)	Emissions Factors - PM10 (lbs/MWh)
FC1200kWe	DIRBGas	863	0.0333	0.0000
FC1200kWe	NG	863	0.0333	0.0000
FC1200kWe	OSBGas	1,079	0.0333	0.0000
FC1200kW	DIRBGas	863	0.0333	0.0000
FC1200kW	NG	863	0.0333	0.0000
FC1200kW	OSBGas	1,079	0.0333	0.0000
GTg2to5MW	DIRBGas	1,440	0.0300	0.0625
GTg2to5MW	NG	1,440	0.0300	0.0625
GTg2to5MW	OSBGas	2,057	0.0300	0.0625
GTle2MW	DIRBGas	1,877	0.0320	0.0625
GTle2MW	NG	1,877	0.0300	0.0625
GTle2MW	OSBGas	2,681	0.0320	0.0625
ICE1500kW	DIRBGas	1,175	0.0335	0.0300
ICE1500kW	NG	1,175	0.0335	0.0300
ICE1500kW	OSBGas	1,679	0.0335	0.0300
ICE500kW	DIRBGas	1,282	0.0413	0.0300
ICE500kW	NG	1,282	0.0413	0.0300
ICE500kW	OSBGas	-6,989	0.0413	0.0300
MT200kW	DIRBGas	1,597	0.0600	0.0192
MT200kW	NG	1,597	0.0600	0.0192
MT200kW	OSBGas	-6,539	0.0600	0.0192
ORC500kW	NA	0	0.0000	0.0000
Storage1MW	NA	0	0.0000	0.0000
Storage25kW	NA	0	0.0000	0.0000
WD1MW	NA	0	0.0000	0.0000

Market Transformation Effects

One of implicit objectives of the SGIP is to help conduct market transformation. More specifically, SGIP represents a publicly funded rebate program that is intended to help reduce the price of DG technologies to the point where these technologies are competitive in the market place without incentives. Ideally, SGIP incentives help support an increase in the demand for DG technologies. The increased demand causes increased production, with associated improvements to the efficiency with which the technology is produced and, potentially, an increase in the technology performance. The improvement in efficiency of production theoretically leads to reduced prices and a self-sustaining market place. Although the California market for DG is insufficient in size to be wholly responsible for any market transformation effects, the California DG market can expect that a certain amount of market transformation will occur, particularly at the engineering, design, and construction steps in the value chain.

The CPUC Decision on cost-effectiveness methodology directed the development of a cost-effectiveness model that incorporated the qualitative aspects of market transformation. Incorporating market transformation into the cost-effectiveness model required an assessment of the historical cost reductions in DG technologies attributable to increased global production. It required the incorporation of recent historical information on technology prices and sales volumes and an assessment of technology development that may occur in the future. In turn, this information was used to examine how increased volumes of sales in California and around the world may contribute to future changes in prices attributable to improvements in technology or manufacturing processes.

To allow the model to make prospective assessments of cost-effectiveness, the model must quantify the market transformation benefit. To do so, we applied the concept of learning curves or experience curves to the different technologies. Learning curves are based on the premise of “learning by doing.” As a new technology is developed and shipped, future units (holding all other inputs constant) will cost less to produce due to improved learning. Based on the maturity of the technology and worldwide distribution, we assumed that costs would decrease at particular rates as the volume of worldwide sales doubled. The evaluation team applied this concept through the development of progress ratios, which were incorporated into the SGIPce model.

A progress ratio of 1 represents no change in the cost of the system over time, regardless of how many units are manufactured. In essence, there is no “learning by doing.” A progress ratio of 0.8 indicates that, based on projected worldwide shipment volumes, the cost of the unit would be reduced by 20% with doubling of the worldwide volumes. The progress ratio was applied on a year-by-year basis.

The progress ratios and worldwide volume estimates were derived for each examined DG technology based on research including analysis of financial data, material content of the

technology, maturity of the technology, interviews with manufacturers, and other published researched. As acknowledged in the CPUC cost-effectiveness decision, "...any market transformation analysis will involve scenario analysis and a host of assumptions. Among other things, these assumptions will likely include varying levels of future total installation costs for DG."⁷ The SGIPce model allows the user to easily undertake multiple scenarios on the progress ratio for each technology to determine the impact of market transformation on the cost-effectiveness of the technology. For example, fuel cells have a lower progress ratio, leading to a larger decline in costs than more mature technologies such as gas turbines, micro turbines, and IC engines.

The progress ratios, used in the base scenario act as a proxy for market transformation, and the related capital costs for the SGIP selected technology can be found in Table 3-7. The capital costs used in the model were derived from independent research. The costs were reported in 2009 dollars and were impacted both by the progress ratio and the impacts of estimated inflation.⁸ The results of the evaluation team's research and full description of the technologies can be found in Appendix A. The cost section below provides a brief discussion of the capital costs.

⁷ http://docs.cpuc.ca.gov/word_pdf/FINAL_DECISION/105926.pdf page 44.

⁸ An inflation level of 2% is used in the SGIPce model. This level is consistent with the E3 avoided cost inputs used in the evaluation.

Table 3-7: SGIPce Technology Progress Ratios and Capital Costs Over Time (Nominal \$/kW)

Technology	Fuel	Progress Ratio	2010	2011	2012	2013	2014	2015	2016
FC1200kWe	NG/DIRBGas	82%	\$8,407	\$7,853	\$7,335	\$6,852	\$6,400	\$5,978	\$5,584
FC1200kWe	OSBGas	82%	\$8,615	\$8,061	\$7,544	\$7,060	\$6,608	\$6,187	\$5,793
FC1200kW	NG/DIRBGas	82%	\$5,613	\$5,243	\$4,897	\$4,575	\$4,273	\$3,992	\$3,728
FC1200kW	OSBGas	82%	\$5,965	\$5,595	\$5,250	\$4,927	\$4,625	\$4,344	\$4,081
GTg2to5MW	NG/DIRBGas	95%	\$2,294	\$2,262	\$2,229	\$2,198	\$2,166	\$2,135	\$2,105
GTg2to5MW	OSBGas	95%	\$2,468	\$2,435	\$2,403	\$2,371	\$2,340	\$2,309	\$2,279
GTle2MW	NG/DIRBGas	95%	\$4,121	\$4,073	\$4,026	\$3,979	\$3,933	\$3,888	\$3,843
GTle2MW	OSBGas	95%	\$4,340	\$4,292	\$4,245	\$4,199	\$4,153	\$4,107	\$4,062
ICE1500kW	NG/DIRBGas	95%	\$1,774	\$1,754	\$1,734	\$1,714	\$1,695	\$1,675	\$1,656
ICE1500kW	OSBGas	95%	\$1,920	\$1,900	\$1,880	\$1,860	\$1,840	\$1,821	\$1,802
ICE500kW	NG/DIRBGas	95%	\$2,070	\$2,046	\$2,022	\$1,998	\$1,974	\$1,951	\$1,928
ICE500kW	OSBGas	95%	\$5,887	\$5,863	\$5,839	\$5,815	\$5,791	\$5,768	\$5,745
MT200kW	NG/DIRBGas	98%	\$3,120	\$3,090	\$3,061	\$3,031	\$3,003	\$2,974	\$2,945
MT200kW	OSBGas	98%	\$9,674	\$9,644	\$9,615	\$9,586	\$9,557	\$9,528	\$9,500
ORC500kW	NA	86%	\$5,764	\$5,704	\$5,645	\$5,588	\$5,532	\$5,478	\$5,424
Storage1MW	NA	80%	\$3,917	\$3,835	\$3,755	\$3,677	\$3,600	\$3,525	\$3,451
Storage25kW	NA	80%	\$6,316	\$6,184	\$6,055	\$5,929	\$5,805	\$5,684	\$5,565
WD1MW	NA	87%	\$2,093	\$2,000	\$1,912	\$1,827	\$1,746	\$1,669	\$1,595

Net Energy Metering Bill Credits

Additional positive DG benefits to the participant are the net energy metering (NEM) credits that customers receive from the investor-owned utilities when they export power to the grid. This export occurs when the power generated from the SGIP-incented technology exceeds the energy needs of the site. Not all DG technologies are eligible for NEM; only wind, fuel cells, and biogas-fueled systems. Unlike NEM for solar, when NEM is available to other DG technologies, it is not always valued at the “full retail rate.”

For the SGIPce model, we assumed that DG systems never export to the grid but instead that all of the electricity generation is consumed on-site.⁹

Rebates/Incentives

A major benefit received by the participant is the incentive for those technologies and systems that qualify. This benefit is part of the PCT. In the case of the SGIPce model, the 2010 SGIP incentives (for the technologies that are now part of the SGIP) were used as a baseline when analysis required the use of an incentive. For DG systems that were not in the program in 2010, but had previously been in the SGIP, the rebates were set to zero in 2010 and then reinstated to their former values for 2011-2016. For new DG technologies that the CPUC instructed Itron to include in the model, incentives were set to values provided by the CPUC. These incentives can be found in Table 3-8. The 20% additional incentive for those technologies that come from a California supplier, as set by D.09-09-048, were not included in the analyses.¹⁰

⁹ However, storage systems were evaluated using an arbitrage assumption under which electricity was provided back to the grid under certain favorable economic pricing situations

¹⁰ http://docs.cpuc.ca.gov/word_pdf/FINAL_DECISION/107574.pdf

Table 3-8: SGIPce Technology Incentives (\$/kW)

Technology	Fuel	2010	2011	2012	2013	2014	2015	2016
FC1200kWe	Natural Gas	\$2.29	\$2.29	\$2.29	\$2.29	\$2.29	\$2.29	\$2.29
	Renewable Fuel	\$4.13	\$4.13	\$4.13	\$4.13	\$4.13	\$4.13	\$4.13
FC1200kW	Natural Gas	\$2.29	\$2.29	\$2.29	\$2.29	\$2.29	\$2.29	\$2.29
	Renewable Fuel	\$4.13	\$4.13	\$4.13	\$4.13	\$4.13	\$4.13	\$4.13
GTg2to5MW	Natural Gas	\$0.00	\$0.17	\$0.17	\$0.17	\$0.17	\$0.17	\$0.17
	Renewable Fuel	\$0.00	\$0.29	\$0.29	\$0.29	\$0.29	\$0.29	\$0.29
GTle2MW	Natural Gas	\$0.00	\$0.00	\$0.00	\$0.00	\$0.00	\$0.00	\$0.00
	Renewable Fuel	\$0.00	\$1.30	\$1.30	\$1.30	\$1.30	\$1.30	\$1.30
ICE1500kW	Natural Gas	\$0.00	\$0.40	\$0.40	\$0.40	\$0.40	\$0.40	\$0.40
	Renewable Fuel	\$0.00	\$0.67	\$0.67	\$0.67	\$0.67	\$0.67	\$0.67
ICE500kW	Natural Gas	\$0.00	\$0.60	\$0.60	\$0.60	\$0.60	\$0.60	\$0.60
	Renewable Fuel	\$0.00	\$1.00	\$1.00	\$1.00	\$1.00	\$1.00	\$1.00
MT200kW	Natural Gas	\$0.00	\$0.80	\$0.80	\$0.80	\$0.80	\$0.80	\$0.80
	Renewable Fuel	\$0.00	\$1.30	\$1.30	\$1.30	\$1.30	\$1.30	\$1.30
ORC500kW	NA	\$0.00	\$0.80	\$0.80	\$0.80	\$0.80	\$0.80	\$0.80
Storage1MW	NA	\$2.00	\$2.00	\$2.00	\$2.00	\$2.00	\$2.00	\$2.00
Storage25kW	NA	\$2.00	\$2.00	\$2.00	\$2.00	\$2.00	\$2.00	\$2.00
WD1MW	NA	\$1.50	\$1.50	\$1.50	\$1.50	\$1.50	\$1.50	\$1.50

For those technologies that we examined that are greater than 1 MW (e.g. 1.2 MW fuel cell), we applied the same SGIP program rules that are valid now, thus the weighted incentive for the fuel cell technologies are not the full \$/Watt but a lower amount.¹¹ For example, a 1.2 MW fuel cell using natural gas as a fuel source will receive \$2.50/Watt for the first MW of capacity and from 1 MW to 2 MW the incentive is \$1.25/Watt. Consequently, a 1.2 MW fuel cell is treated by assigning 1 MW at \$2.50/Watt, then 200 kW at \$1.25/Watt, resulting in a weighted incentive of \$2.29/Watt.

Reduced Electricity Bills

A reduced electricity bill is a primary participant benefit within the PCT test. The reduced electricity bill was estimated based on reduction in the consumption of electricity over an 8,760 hour per year profile due to the DG system providing the necessary on-site electricity demands and using the utility’s commercial rates.¹² The model also assumes that the DG technologies

¹¹ www.cpuc.ca.gov/NR/rdonlyres/F47DC448-2AEB-473F-98D8-CC0CC463194D/0/2010_SGIP_Handbookr4100506.pdf, page 23.

¹² The residential technologies used a residential rate.

lead to an 80% demand savings factor consistent with their 8,760 hourly load reduction for all technologies other than wind and storage. The utility rates were developed from actual 2010 utility rates. The forecast of rates incorporates a 2% inflation rate and the real growth in prices from the CEC California Energy Demand (CED) forecast.

Table 3-4 lists example yearly utility rate weighted averages for the three electrical utilities. The actual yearly average rate used in the SGIPce model depends on the DG technology production curves and the utility. The rates presented in Table 3-4 indicate that SDG&E has lower average rates within the model than PG&E and SCE.

Reliability Benefits

DG systems may improve electrical system reliability under certain circumstances; for example, by providing a dispersed and versatile source of power supply. For this benefit we used the E3 electrical avoided cost model which assumes reductions in demand caused by DG have at least roughly the same reliability impacts as changes in demand caused by energy efficiency. This benefit was applicable in the PA, TRC, and STRC benefit cost models in the SGIPce.

Standby Charge Exemption

Some DG equipment (wind, solar and biogas supplied fuel cells) are exempt from standby charges up to a particular size. Standby is a charge for the potential use of a utility service including system backup support as well as other running and quick-start capabilities. This benefit is part of the participant test and it is represented in the tariff of additional savings the SGIP participants receives, if applicable for that particular technology. For the SGIPce model, we did not include standby charges for any technology because we did not have access to demand data.

Tax Credits/Depreciation

As part of the installation of a DG system, the participant and society benefits include the federal investment tax credit (ITC) and the acceleration of the depreciation expenses. Both of these tax subsidies are provided in Table 3-9 along with other technology attributes. The TRC and STRC also incorporate the federal income tax implications associated with DG technology operating costs. Specifically, the federal income tax code allows host sites to reduce their taxable income by their business operating costs, including the operating and maintenance costs of DG technology. For DG technologies fueled by natural gas, directed biogas, and on-site biogas, the operating cost and the resulting reduction in tax liabilities or increase in tax refund may be substantial. The PCT incorporates both the state and the federal income tax implications associated with DG technology operating costs.

Table 3-9: Technology ITC Percent and Depreciation Term

Technology	ITC Percent	Depreciation Term
FC1200kWe	30.0%	5
FC1200kW	30.0%	5
GTg2to5MW	10.0%	5
GTle2MW	10.0%	5
ICE1500kW	10.0%	5
ICE500kW	10.0%	5
MT200kW	10.0%	5
ORC500kW	10.0%	5
Storage1MW	30.0%	15
Storage25kW	30.0%	15
WD1MW	30.0%	5

Note: Based on current federal law, these are valid through 2016.

Utility Interconnection not Charged to DG Customer

When DG systems are interconnected into the electrical grid, there is typically an interconnection study conducted and a cost associated with the interconnection. In some DG systems, the cost of this study is not paid by the participant. However, upgrades required on the electrical system as a result of the installation of the DG system are paid for by the participant. These benefits and costs vary widely across applications and utilities. The evaluation team could not find representative values that could accurately identify these specific costs and benefits to all DG technologies; therefore, they were not included in the SGIPce model.

3.1.2 Critical Inputs—Costs

Table 3-10 lists the costs for the various cost-effectiveness tests as outlined in Attachment A of D.09-08-026.¹³ Following the table are brief summaries of the costs used and their sources. In some cases the participant benefit will manifest itself as a Program Administrator cost.

¹³ http://docs.cpuc.ca.gov/published/FINAL_DECISION/105928.htm

Table 3-10: Costs for the Cost-Effectiveness Tests

Costs	PCT	TRC	STRC	PA
Costs of DG system, interconnection, emission controls and offset purchases	Included	Included	Included	NA
Increased IOU fuel transportation costs for gas-fired DG	NA	NA	NA	Included
Net energy metering costs	NA	NA	NA	Not Included
Nonbypassable charges (PGC, DWR, nuclear decommissioning)	Included	NA	NA	NA
Operation maintenance, fuel, ongoing emission offset purchases	Included	Included.	Included	NA
Program administration	NA	Included	Included	Included
Reliability costs (system cost of additional ancillary services/VAR support)	NA	Not Included	Not Included	Not Included
Removal costs (less salvage)	Not Included	Not Included	Not Included	NA
Utility interconnection	NA	Not Included	Not Included	Not Included
Utility rebates/incentives	NA	NA	NA	Included

DG System, Interconnection, and Emission Controls Costs

A major list of costs that are included in the PCT, TRC, and STRC are the capital costs for the equipment, installation, air pollution emission controls, and other costs associated with the capital. The evaluation team’s estimates for this capital are included in Table 3-7. These costs were estimated from data on SGIP installations and secondary research. The secondary research included published data, financial reports, industry periodicals, and interviews with manufacturers. The costs for technologies using on-site biogas fuel are higher than for the same technology using natural gas or directed biogas. The capital costs included in Table 3-7 display the effect of alternative progress ratios, as previously discussed.

Increased Utility Fuel Transportation Costs

Running and operating a gas-fired DG system requires additional natural gas from the gas utility and, as a result, a higher transportation charge. In California, gas-fired DG within the residential sector leads to higher natural gas fuel transportation costs by them within the PA test. The

increased gas transportation costs were valued according to rates available within the E3 gas avoided cost workbook. The model does not incorporate higher transportation costs for commercial customers within the PA test because these customers are modeled as wholesale gas (noncore) customers and were set to zero.

Net Energy Metering Costs

NEM costs would typically be included in the costs for the PA. However, in the SGIPce model we assumed that the DG systems never exported electricity to the grid; therefore, these PA costs do not exist in SGIPce model.

Nonbypassable Charges

With some DG programs, when electrical load departs, departing load (DL) charges can be avoided depending on the technology and fuel source. These costs are known as non-bypassable charges or cost responsibility charges (CRC). These CRCs include a number of liabilities such as Department of Water (DWR) bond charges or DWR power charges¹⁴, and historic procurement charges (HPCs). The majority of these costs are not paid by DG systems up to a particular size or depending on how they are classified. See Table 3-11 below for a summary or reference D.03-04-030 for a complete breakdown on these costs and the rationale for determining which technologies are exempt.

Generally, customer generation DL that is under 1 MW and eligible for the CPUC or the CEC's incentive programs does not incur any CRC per the seventh ordering paragraph D.03-04-030. Nuclear decommissioning and public purpose charges are not part of the CRC.

¹⁴ The DWR Power Charge has long since been replaced by the Power Charge Indifference Adjustment (PCIA).

Table 3-11: Summary of Departing Load Exemption by Technology

Technology	Fuel	Departing Load Charge
FC1200kWe	DIRBGas	Exempt until 1 MW then subject to some charges above 1 MW if defined as ultra clean*
FC1200kWe	NG	Exempt until 1 MW then subject to some charges above 1 MW if defined as ultra clean
FC1200kWe	OSBGas	Exempt regardless of size†
FC1200kW	DIRBGas	Exempt until 1 MW then subject to some charges above 1 MW if defined as ultra clean
FC1200kW	NG	Exempt until 1 MW then subject to some charges above 1 MW if defined as ultra clean
FC1200kW	OSBGas	Exempt regardless of size
GTg2to5MW	DIRBGas	Exempt up to 1 MW, then subject to DL‡
GTg2to5MW	NG	Exempt up to 1 MW, then subject to DL
GTg2to5MW	OSBGas	Exempt regardless of size
GTle2MW	DIRBGas	Exempt up to 1 MW, then subject to DL
GTle2MW	NG	Exempt up to 1 MW, then subject to DL
GTle2MW	OSBGas	Exempt regardless of size
ICE1500kW	DIRBGas	Exempt up to 1 MW, then subject to DL
ICE1500kW	NG	Exempt up to 1 MW, then subject to DL
ICE1500kW	OSBGas	Exempt regardless of size
ICE500kW	DIRBGas	Exempt under 1 MW
ICE500kW	NG	Exempt under 1 MW
ICE500kW	OSBGas	Exempt regardless of size
MT200kW	DIRBGas	Exempt under 1 MW
MT200kW	NG	Exempt under 1 MW
MT200kW	OSBGas	Exempt regardless of size
ORC500kW	NA	Exempt under 1 MW
Storage1MW	NA	Exempt under 1 MW
Storage25kW	NA	Exempt under 1 MW
WD1MW	NA	Exempt under 1 MW

* See ordering paragraph 8 in D. 03-04-030.

† See ordering paragraph 6 in D. 03-04-030.

‡ See ordering paragraph 7 in D. 03-04-030.

Operations, Maintenance, Fuel, and Emission Offset Purchases

Related to the cost of the system are the ongoing or variable costs of the DG equipment. These costs are included in the PCT, the TRC, and STRC. For the PCT, TRC, and STRC the O&M costs include insurance and yearly maintenance that was derived for all the technologies on a \$/kWh basis. The maintenance costs included those costs required to maintain the system including periodic overhauls or replacement of system components (e.g., the stack in the case of fuel cells). The non-fuel related O&M costs are available in Table 3-2.

Fuel expenses for natural gas and directed biogas-fueled technologies are also included in the costs for the PCT, TRC, and STRC. For the PCT, values of the natural gas are based on the non-core gas rates for commercial and government/nonprofit participants and based on core rates for residential customers. For commercial and government/nonprofit customers, the utility-specific DG T&D charges were added to the wholesale gas rates when calculating the gas fuel costs within the PCT. For the commercial and government/nonprofit analysis, the model employed wholesale gas rates and the rate forecast underlying the E3 avoided cost forecast. The TRC and STRC also include a fuel cost. This fuel cost is valued using the avoided cost gas commodity rates in the E3 avoided cost model for commercial and government/nonprofit participants and the avoided cost gas commodity and T&D rates from the E3 avoided cost model for residential participants.¹⁵

Directed biogas is biogas that has been procured off-site and is then injected into the natural gas pipeline.¹⁶ The cost increase for the use of directed biogas as a fuel source was based on data received from the CPUC and from discussions with technology providers who were exploring the use of directed biogas in their projects. The directed biogas adder used by the evaluation team for the base year of 2009 is \$0.412 per therm. This value is added to the natural gas rate used for the PCT. The growth rate of the direct biogas adder is 2.97% per year. This cost increase was applied only to the adder. Different cost increases were applied to the natural gas rates. The STRC and the TRC use the same avoided cost values for both natural gas and directed biogas.

The model also accounts for any increased GHG emissions resulting from using DG technologies to produce electricity instead of procuring this electricity from the grid.¹⁷ The

¹⁵ The transportation and distribution charges were not included in the government and commercial customers because these customers were modeled as non-core gas customers for whom the utilities do not have to plan in the T&D planning.

¹⁶ For more information on directed biogas, please see D.09-09-048.
http://docs.cpuc.ca.gov/word_pdf/FINAL_DECISION/107574.pdf

¹⁷ The avoided cost benefits associated with the reduction in utility-provided electricity included the value of reduced GHG emissions from central station power stations. The TRC and the STRC must, therefore, include costs associated with the GHG emissions produced by DG technologies.

technology-specific GHG emission rates are listed in Table 3-6. The emissions were valued according to the mid-GHG values forecast in the E3 avoided cost model.

Program Administration Costs

These costs are used in the PA, TRC, and STRC benefit-cost models. They were derived from the installed kW of SGIP projects divided by the total program administration expenses reported to the CPUC on an annual basis for the years 2007-09. This average PA cost per kW installed was then applied to the technology being installed.

Reliability Costs

For these costs we assumed that the DG systems did not add to reliability of services, so it was neither a benefit nor a cost.

Removal and Salvage Costs

These costs were not included in the model. The evaluation team assumed the systems were run for 20 years and their present value removal costs were negligible.

Utility Interconnection Costs

While there is a subsidy for the interconnection of DG and the net metering bills, we assumed that these costs were not material for the analysis; therefore, we did not include them.

Utility Rebates/Incentives

The incentive rebates identified as a benefit for the participant listed above is a cost to the PAs; therefore, it is included in the cost for the PA test. The incentive values per Watt can be found in Table 3-8.

3.2 Cost-Effectiveness Methodology

3.2.1 Societal Total Resource Cost Test and the Total Resource Cost Test

The Societal Test can be considered a variant of the SPM's Total Resource Cost Test (STRC). The STRC measures the net costs of a DG program as a resource option based on the total costs of the program, including both the participants' and the utility's costs. The STRC and the TRC tests help to determine if society's total resources are improved by a technology or a program.

The Societal Benefit-Cost Ratio is given by:

$$\text{Societal Benefit-Cost Ratio} = \frac{\text{Societal Benefits}}{\text{Societal Costs}}$$

Benefits

The STRC includes a variety of benefits characterized as avoided costs or avoided cost adders, including avoided generation costs, avoided transmission and distribution (T&D) costs, line loss reductions, a reliability adder, an environmental adder, waste heat utilization benefits, and tax credits and depreciation. For many of these benefits, this evaluation used benefit values derived from The Distributed Generation Avoided Cost workbook provided by E3 for the Commission. The environmental adder within the avoided cost study attributes a monetary value to the reduction in carbon, oxides of nitrogen (NO_x), and particle matter smaller than 10 microns (PM₁₀) that results from the reduction in electricity produced and purchased from conventional supply resources. For technologies fueled by on-site biogas at sites that previously did not participate in methane capture, the per unit monetary value of GHG derived from the avoided cost workbooks is applied to the reduced methane discharge.

The DG STRC and TRC benefits and the sources for the value of these benefits are listed below:

- Avoided generation costs, as valued by the E3 electric forecast,
- Avoided transmission and distribution costs, as valued by the E3 electric forecast,
- Reliability net benefits, as valued by the E3 electric forecast,
- Reduced line losses associated directly with reductions in power purchases by DG participants as valued by the E3 electric forecast,
- Environmental benefits from reduced central plant electricity production, as valued by the E3 electric forecast,
- Environmental benefits from methane capture at small technology sites fueled by on-site biogas valued at the E3 forecast of GHG prices,¹⁸
- Federal tax credits, federal tax refunds, and depreciation benefits valued at technology-specific levels, and
- Waste heat benefits of CHP applications valued by the E3 gas forecast.

¹⁸ Microturbines 200 kW and internal combustion engines 500 kW fueled by on-site bio-gas are assumed to be installed at dairy sites. The installation of these measures at dairies leads to methane capture and substantial environmental benefits.

The societal benefits associated with individual technologies (*SocietalBenefits_i*) are estimated by:

$$SocietalBenefits_i = AvoidedElectricCosts_i + TaxBenefits_i + WasteHeatBenefits_i$$

where *AvoidedElectricCosts_i* represents the avoided electric costs associated with technology *i*, *TaxBenefits_i* are the tax benefits for technology *i*, and *WasteHeatBenefits_i* reflects total waste heat benefits associated with technology *i*.

Avoided electric costs for each technology were developed on an annual basis for the assumed lifetime of the technology, then discounted back to present value. That is:

$$AvoidedElectricCosts_i = \sum_{t=0}^T \frac{AvoidedElectricCosts_{it}}{(1+d)^t}$$

where *t* denotes the year in question, *T* is the lifetime of the technology, and *d* is a societal discount rate for the STRC test and a private discount rate for the TRC test.¹⁹ For each technology, annual avoided electric costs were developed at the hourly and regional level,²⁰ then summed over regions and hours to create annual values for the technology in question:

$$AvoidedElectricCosts_{it} = \sum_{r=1}^R \sum_{h=1}^{8760} \Delta kWh_{irh} AvCost_{irht}$$

where ΔkWh_{irh} is the hourly electricity output of technology *i* in region *r*, and $AvCost_{irht}$ is the avoided electric cost per kWh in hour *h* in year *t* in region *r* for technology *i*. The regions used in the evaluation incorporated a coastal and inland region for each utility. This specification required hourly energy impacts by technology and region to be applied to the relevant hourly profile of avoided generation costs. The hourly impacts were derived from metered hourly generation load profiles developed by Itron using existing SGIP sites. The hourly avoided cost rates include avoided costs of generation ($AvGCost_{hrt}$), avoided cost of transmission and distribution ($AvTDCost_{hrt}$), an environmental adder that varies across technology ($EnvAdd_{ihrt}$), and a reliability adder ($ReAdd_{ihrt}$). Avoided generation costs take into account line losses on displaced purchases.

¹⁹ The Total Resource Cost Test differs from the Societal Total Resources Cost Test in the use of a private discount rate instead of the societal discount rate.

²⁰ The regional level was defined as coastal and inland for each utility. The E3 avoided costs were aggregated into inland and coastal values using the past SGIP installed generation as weights.

Tax benefits include the federal ITC, potential tax refunds associated with the flow of investment and operating costs, and depreciation tax benefits. These benefits are computed as the present value of annual values:

$$TaxBenefits_i = \sum_{t=1}^T \frac{InvestmentTaxCredit_i + FederalRefund_{it} + Depreciation_{it}}{(1+d)^t}$$

The investment tax credit is a first year credit dependent on the technology and the cost of the technology. The depreciation tax benefit is also dependent on the type of technology and the cost of the technology. Depending on the type of technology, the depreciation tax credit may be spread over as few as five years or extended over 15 years. The federal tax refund is calculated yearly based on corporate tax rates, investment and financing costs, and operating and maintenance expenses.

Waste heat benefits are applicable for CHP applications and are computed as the present value of annual values:

$$WasteHeatBenefits_i = \sum_{t=1}^T \frac{WasteHeatBenefits_{it}}{(1+d)^t}$$

The annual values of waste heat benefits are given by:

$$WasteHeatBenefits_{it} = \sum_{m=1}^{12} DisTherms_{im} AvGasCost_{mt}$$

where $DisTherms_{im}$ is the gas consumption displaced by technology i in month m and $AvGasCost_{mt}$ is the avoided cost of gas in month m and year t .

Costs

The STRC and the TRC tests include total resource costs for DG technologies. Total resource costs include five elements: 1) equity investment; 2) financing costs; 3) operating and maintenance (O&M) costs, including fuel costs (where applicable) and insurance costs; 4) environmental costs; and 5) program administration costs, including marketing, measurement, and evaluation costs. A short description of these costs and the sources of their valuation are listed below.

- Equity costs assume a 60% equity investment, value of costs derived from secondary sources, and actual SGIP site costs. Forecast of costs are based learning curves.
- Finance costs assume a 40% debt financing of the DG measure cost using a market interest rate and a finance period of 80% of the measure life.
- O&M costs are derived from secondary sources and fuel costs valued by the E3 gas commodity forecast.
- Environmental costs from DG electricity production, as valued by the E3 forecast of GHG values.
- Program and administrative costs are derived from actual SGIP costs per MWh produced.

Given the specifications of D.09-08-026 from August 20, 2009, the perspective of the STRC test differs from the TRC test in only the discount rate. The societal test uses a societal discount rate that is generally lower than the private discount rate used in the TRC. The decision also specified that, for the STRC and the TRC, “federal tax incentives should be included if we define the relevant ‘society’ as California and the benefits of these incentives flows into California from federal taxpayers.”

In summary, societal costs include equity investment (*Equity*), financing costs (*Finance*), operating costs (*O&MCost*), environmental costs (*EnvCost*), and program administrative costs (*AdminCost*). The present value of technology-specific societal costs is given by:

$$SocietalCosts_i = Equity_i + Finance_i + O \& MCost_i + EnvCost_i + AdminCost$$

The initial equity investment and program administration costs are assumed to be incurred in the year of the program. Financing costs, O&M costs, and environmental costs occur over the lifetime of the DG technology and are discounted back to present value by using the societal discount rate for the STRC and a private discount rate for the TRC.

The O&M component of the costs (which includes the technology specific maintenance costs, the fuel costs for gas fired DG, and the insurance costs) is given by:

$$O \& MCost_i = \sum_{t=1}^T \frac{O \& MCost_{it}}{(1+d)^t}$$

Note that, for gas-fired DG applications, the yearly fuel cost component of O&M costs is given by:

$$FuelCost_{it} = \sum_{m=1}^{12} ThermsUse_{imt} AvCostGas_{imt}$$

where $ThermsUse_{imt}$ is the monthly usage of natural gas for the DG application and $AvCostGas_{imt}$ is the monthly commodity avoided cost of gas.²¹

The environmental pollutions produced during the production of electricity using DG measures is technology-specific and a function of the quantity of electricity produced. The yearly environment cost associated with the production of electricity is given by:

$$EnvCost_{it} = MWHProd_{it} GHGEmission_i EmissionCost_t$$

where $MWHProd_{it}$ is the yearly electricity production for the DG technology, $GHGEmission_i$ is the pounds of GHG produced per MWh of electricity produced, and $EmissionCost_t$ is the yearly cost per pound of GHG produced. The yearly cost per pound is derived from the E3 gas avoided costs mid case scenario.

3.2.2 Participant Test

The Participant test attempts to measure the change in the participant’s well-being from participating in the DG program. The test is commonly viewed as a conservative measure of the change in the participant’s well-being as it does not incorporate monetary values associated with intangibles such as the participant’s value of installing a “green” technology. The Participant test value can be used to assess the change in the participant’s well-being associated with program changes, such as changes in rebate values or rebate form.

²¹ For commercial customers the avoided cost of gas does not include the T&D or the environmental components. Commercial customers are assumed to be non-core gas customers and the utilities are not required to plan their distribution network for these customers. The environmental component of the avoided costs is not included because each technology creates a unique environmental signature that is incorporated in a separate component.

The Participant Benefit-Cost Ratio is given by:

$$\text{Participant Benefit-Cost Ratio} = \frac{\text{ParticipantBenefits}}{\text{ParticipantCosts}}$$

Benefits

Participant benefits include electricity bill savings, CHP gas bill savings, incentives, REC credits for green technologies, and state and federal tax savings.

- Reductions in electricity bills are the sum of hourly reductions in purchases of electricity, valued at the appropriate retail rates on the energy component.
- Reductions in billing demand are valued at the appropriate demand charge component.
- Reductions in gas bills associated with the heat usage for CHP sites are valued at the wholesale gas price with utility specific T&D charges incorporated.
- Incentives valued at current SGIP values for 2010 assume re-establishment of incentives for 2011-2016 for evaluated DG measures without incentives in 2010.
- REC benefits for green technologies are valued at \$0.035/ kWh over the forecast period.
- State tax savings incorporate taxable operating costs, depreciation benefits, equity and financing cost evaluated at the state corporate tax rate (8.84%).
- Federal investment tax credit valued at technology-specific values.
- Federal tax savings incorporate program rebates, taxable operating costs, depreciation benefits, and equity and financing cost evaluated at a federal corporate tax rate (35%).

Many of the participant benefits vary significantly by technology. The technology-specific participant benefits are given by:

$$\text{ParticipantBenefits} = \text{RedElecBills}_i + \text{ValDispFuels}_i + \text{Inc}_i + \text{IncO}_i + \text{TC}_i + \text{TB}_i$$

where Inc_i represents SGIP incentives, IncO_i reflects other incentives including REC credits, TC_i is the federal ITC, and TB_i are state and federal tax savings associated with participating in the DG program. The value of the saving associated with heat usage at CHP sites is represented by (ValDispFuels_i).

Reductions in electric bills ($RedElecBills_i$) are the sum of reductions in energy charges ($RedEnChg_i$) and reductions in demand charges ($RedDemChg_i$). Note that these reductions are net of any charges associated with the use of DG, like standby charges and departing load charges, if any.

$$RedElecBills_i = RedEnChg_i + RedDemChg_i$$

Each of these elements of bill impacts is computed as a present value of the associated streams of bill effects:

$$RedEnChg_i = \sum_{t=1}^T \frac{RedEnChg_{it}}{(1+d)^{t-1}}$$

$$RedDemChg_i = \sum_{t=1}^T \frac{RedDemChg_{it}}{(1+d)^{t-1}}$$

Annual reductions in energy and demand charges are computed as:

$$RedEnChg_{it} = \sum_{p=1}^P \sum_{h=1}^{8760} \Delta kWhOnSite_{iph} EnergyRate_{pht}$$

and

$$RedDemChg_{it} = \sum_{p=1}^P \Delta kWOnSite_{ipt} DemChg_{pt}$$

where $\Delta kWhOnSite_{iph}$ and $\Delta kWOnSite_{ipt}$ indicate reductions in on-site energy use and billing demand, respectively, and $EnergyRate_{pht}$ and $DemChg_{pt}$ reflect the prevailing energy and demand charges for customers on rate p .

The value of displaced fuels for CHP applications is the present value of the stream of future cash flows:

$$ValDispFuels_i = \sum_{t=1}^T \frac{ValDispFuels_{it}}{(1+d)^{t-1}}$$

The annual value of displaced fuels will be computed as:

$$ValDispFuels_{it} = DisTherms_{it} PGas_t$$

where $PGas_t$ is the price of natural gas for non-core customers in year t .

Costs

Participant costs include the following elements for the DG system:

- Equity costs assume a 60% equity investment, value of costs derived from secondary sources, and actual SGIP site costs. Forecast of costs are based on learning curves.
- Finance costs assume a 40% debt financing of the DG measure cost using a market interest rate and a finance period of 80% of the measure life.
- O&M costs are derived from secondary sources and fuel costs valued by the wholesale gas forecast.

Equipment costs include all planning, design, development, equipment and installation costs associated with the DG facilities installed under the program. Installed costs include any up-front environmental costs, including controls and the cost of fuel clean-up for on-site biogas applications (see Table 3-7 above for these costs).

Participant costs for a technology can be expressed as:

$$ParticipantCosts_i = Equity_i + Finance_i + O \& M Costs_i$$

where $Equity_i$ is the cost of the technology paid for at the time of installation, $Finance_i$ are the repayment of debt and the sum of interest paid over the life of the loan, and $O \& M Costs_i$ reflects O&M costs occurred over the life of the technology including fuel costs. The present value of the finance costs are defined as:

$$Finance_i = \sum_{t=1}^T \frac{Finance_t}{(1+d)^{t-1}}$$

The two components of the finance are given by

$$Finance_i = \sum_{t=1}^T \frac{Debt_t + Interest_t}{(1+d)^{t-1}}$$

where $Debt_t$ is the yearly debt payment and $Interest_t$ is the yearly interest payment. The financing of the measure is assumed to cover 40% of the cost of the technology and last for 80% of the technology's expected life of the technology.

The present value of the O&M costs are defined as:

$$O \& M Cost_i = \sum_{t=1}^T \frac{O \& M Cost_{it}}{(1+d)^{t-1}}$$

The fuel cost component of participant O&M costs is given by:

$$FuelCost_i = \sum_{t=1}^T \frac{FuelCost_{it}}{(1+d)^t}$$

where annual fuel costs are computed as:

$$FuelCost_t = \sum_{m=1}^M ThermsUse_{mt} PriceGas_{mt}$$

where $ThermsUse_{mt}$ is the monthly usage of natural gas for the DG application and $PriceGas_{mt}$ is the monthly non-core customer retail price of natural gas. In the case of directed biogas, an addition cost per therm is added to the price of natural gas to account for the use of directed biogas. For technologies fueled by on-site biogas, there are no fuel costs but these sites pay higher O&M costs associated with maintenance and higher initial technology costs.

3.2.3 Program Administrator Test

The PA test attempts to determine how the utility’s revenue requirements are changed due to the utility administering the DG program. The PA Benefit-Cost Ratio is given by:

$$\text{Program Administrator Benefit-Cost Ratio} = \frac{\text{Program Administrator Benefits}}{\text{Program Administrator Costs}}$$

Benefits

PA benefits include electricity avoided cost savings and CHP gas avoided cost savings.

- Avoided generation costs, as valued by the E3 electric forecast.
- Avoided transmission and distribution costs, as valued by the E3 electric forecast.
- Reliability net benefits, as valued by the E3 electric forecast.
- Reduced line losses associated directly with reductions in power purchases by DG participants, as valued by the E3 electric forecast.
- Environmental benefits from reduced central plant electricity production, as valued by the E3 electric forecast.
- Waste heat benefits of CHP applications valued by the E3 gas forecast.

The PA benefits associated with individual technologies (*Program Administrator Benefits_i*) is given by:

$$\text{Program Administrator Benefits}_i = \text{Avoided Electric Costs}_i + \text{Waste Heat Benefits}_i$$

where *Avoided Electric Costs_i* represents the avoided electric costs associated with technology *i* and *Waste Heat Benefits_i* reflects the utilities gas costs associated with waste heat benefits from technology *i*.

Avoided electric costs for each technology were developed on an annual basis for the assumed lifetime of the technology, then discounted back to present value. That is:

$$\text{Avoided Electric Costs}_i = \sum_{t=0}^T \frac{\text{Avoided Electric Costs}_{it}}{(1+d)^t}$$

Where *t* denotes the year in question, *T* is the lifetime of the technology, and *d* is the utility’s discount rate. For each technology, annual avoided electric costs were developed at the hourly

and regional level,²² then summed over regions and hours to create annual values for the technology in question:

$$AvoidedElectricCosts_{it} = \sum_{r=1}^R \sum_{h=1}^{8760} \Delta kWh_{irh} AvCost_{irht}$$

where ΔkWh_{irh} is the hourly electricity output of technology i in region r , and $AvCost_{irht}$ is the avoided electric cost per kWh in hour h in year t in region r for technology i . This specification required hourly energy impacts by technology and region to be applied to the relevant hourly profile of avoided generation costs. The hourly impacts were derived from metered hourly generation load profiles developed by Itron using existing SGIP sites. The hourly avoided cost rates include avoided costs of generation ($AvGCost_{hrt}$), avoided cost of transmission and distribution ($AvTDCost_{hrt}$), an environmental adder that varies across technology ($EnvAdd_{ihrt}$), and a reliability adder ($ReAdd_{hrt}$). Avoided generation costs take into account line losses on displaced purchases.

Waste heat benefits are applicable for CHP applications and are computed as the present value of annual values:

$$WasteHeatBenefits_i = \sum_{t=1}^T \frac{WasteHeatBenefits_{it}}{(1+d)^t}$$

The annual values of waste heat benefits are given by:

$$WasteHeatBenefits_{it} = \sum_{m=1}^{12} DisTherms_{im} AvGasCost_{mt}$$

where $DisTherms_{im}$ is the gas consumption displaced by technology i in month m and $AvGasCost_{mt}$ is the avoided cost of gas in month m and year t . Commercial and government customers are modeled as non-core gas customers; the utility is not the provider of gas to these customers. Commercial and government customers are assumed to purchase their gas on the wholesale market. For these customers the gas avoided cost savings are zero. Residential DG technologies were not modeled as CHP technologies.

²² The regional level was defined as coastal and inland for each utility. The E3 avoided costs were aggregated into inland and coastal values using the past SGIP installed generation as weights.

Costs

The PA test includes total resource costs for DG technologies. Total resource costs include three elements: 1) rebates, 2) utility-provided fuel costs, and 3) program administration costs, including marketing, measurement, and evaluation costs. A short description of these costs and the sources of their valuation are listed below.

- Rebate or incentive costs, valued at current SGIP incentives for 2010. For 2011-2016 incentives were developed for evaluated technologies that did not have SGIP incentives in 2010.
- Fuel costs valued by the E3 gas commodity forecast for sectors consuming utility gas.
- Program and administrative costs derived from actual SGIP costs per MWh produced.

The present value of technology-specific program administrative costs is given by:

$$ProgramAdministrativeCosts_i = Incentive_i + UtilityFuelCost_i + AdminCost$$

The incentives are modeled as first year or upfront incentives consistent with SGIP incentive available in 2010. For the 2011-2016 forecast of cost-effectiveness, the incentives are adjusted for those technologies with no incentives in 2010.

The utility fuel cost component of the costs is given by:

$$UtilityFuelCost_i = \sum_{t=1}^T \frac{UtilityFuelCost_{it}}{(1+d)^t}$$

The yearly fuel cost is given by:

$$FuelCost_{it} = \sum_{m=1}^{12} ThermsUse_{imt} AvCostGas_{imt}$$

where $ThermsUse_{imt}$ is the monthly usage of natural gas for the DG application and $AvCostGas_{mt}$ is the monthly commodity avoided cost of gas for customers who receive their gas from the utility. Commercial and government customers are modeled as non-core gas customers who receive their gas from a wholesale distributor. Residential customers are modeled as receiving their gas from the utility.

3.2.4 Levelized Results

For each of the tests, the costs and the benefits for a DG technology installed in year X (e.g., year 2010) were calculated for each year of the life of the technology. These benefits and costs were brought to the present value from when the device was installed and then these benefits were converted to equal amounts for the life of the measure or levelized. We chose to have the costs levelized in order to be similar to the E3 cost-effectiveness model used for the NEM and for the CSI.

3.2.5 Modified Internal Rate of Return

The SGIPce model also calculates the modified internal rate of return (MIRR). The MIRR is a financial evaluation of an investment's attractiveness and can be used to rank alternative investments. As the name indicates, the MIRR is a modification of the more common internal rate of return (IRR) calculation.

The MIRR calculation is preferred to the IRR for two reasons. First, the MIRR assumes that the positive cash flows of the investment or DG technology are reinvested by the firm at the firm's weighted average cost of capital (WACC), while the IRR assumes that the positive cash flows are reinvested at the IRR of the original investment. If the original investment had a high IRR it is highly unlikely that the cash flows from the project will also find an equally good investment opportunity. Using the MIRR will produce a lower and more realistic evaluation of the project's forecasted rate of return. Second, the IRR calculation can produce multiple and incorrect results if the cash flows from the project begin negative (initial capital investment), turn toward a positive cash flow, and then experience negative cash flow, as was the case of some technologies in years generally more than five years out from the initial installation. The MIRR calculation can accurately calculate the rate of return for projects with these dynamic cash flows. Investments where the MIRR exceeds the firm's weighted average cost of capital are typically considered good investment opportunities for the firm.

4

SGIPce Model Approach and Methodology

4.1 Overview

In accordance with the adopted decision on distributed generation (DG) cost-effectiveness methodology,¹ the Energy Division of the California Public Utilities Commission (CPUC) contracted for the development of two models and studies that could evaluate the cost-effectiveness of DG technologies or a portfolio of DG technologies (i.e., DG program). One model is designed to review the cost-effectiveness of solar photovoltaic (PV) technologies installed under the California Solar Initiative (CSI) program. The second model is designed to review a broader set of DG technologies installed under the Self-Generation Incentive Program (SGIP). The resulting SGIP cost-effectiveness model (SGIPce) provides a publicly available modeling tool built in Microsoft Excel 2007 for this purpose.

This section is designed to give the reader an overview of the SGIPce model and discusses the approach, objectives and structure of the model. It also looks at the various components of the model and describes how they contribute to the desired result. Note that this is not a User Guide for the model; the SGIPce User Guide is supplied separately in Appendix B. The User Guide will also be distributed with the model itself.

4.2 Model Objectives

The objectives of the SGIPce model are as follows:

- Uses the Standard Practice Manual tests modified in accordance with the ALJ ruling to evaluate cost-effectiveness (08-03-008).² Tests implemented are:
 - Participant Cost Test,
 - Total Resource Cost Test,
 - Societal Total Resource Cost Test, and
 - Program Administrator Cost Test.

¹ California Public Utilities Commission, Decision 09-08-026, August 2009, pg. 4.
http://docs.cpuc.ca.gov/word_pdf/FINAL_DECISION/105926.pdf

² California Public Utilities Commission, R.08-03-008, June 19, 2009.

- Provides comprehensive coverage of DG technologies.
 - Technologies implemented include PV, wind, Organic Rankine Cycle waste heat turbines (ORC), combustion-based microturbines, fuel cells, IC engines, and gas turbines fueled by natural gas, biogas, or directed biogas.
 - Also included is storage/dispatch.
- Allows evaluation of DG technologies currently and in the future.
 - Based on historical costs and metered performance.
 - Projects future costs and energy production based on learning curves, program requirements, and observed production of metered technologies currently installed.
- Allows for the evaluation of the Modified Internal Rate of Return (MIRR) at alternative incentive levels.

These objectives are met through the development of the SGIPce model by incorporating the inputs, calculations, and the Levelized Cost of Energy (LCOE) framework into a system capable of analyzing the data and storing results in an open structure of Excel workbooks. The rest of this section describes the basic structure of the model, its functionality, the inputs and the outputs.

4.3 Model Approach

Development of the SGIPce model began with the Energy and Environmental Economics (E3) CSI ProForma LCOE worksheet. The E3 model is designed to calculate the levelized cost of energy for PV systems. The E3 model was modified to enable the analysis of Combined Heat and Power (CHP), storage, and wind systems to provide a model capable of analyzing the cost-effectiveness of multiple types of DG technologies. The SCIPce system was built by surrounding the modified LCOE worksheet with a set of input worksheets and workbooks used to provide inputs and to store outputs used and generated by the DG cost-effectiveness system. The primary outputs of the SGIPce system are the program- and technology-specific cost-effectiveness tests.

4.4 Model Structure

The general structure of the model can be seen in Figure 4-1 below. Each box in this figure represents one or more Excel 2007 workbooks. This section gives a basic overview of the structure of the model and how these workbooks fit together. The structure of the model is described in more detail in the SGIPce User Guide found in Appendix B of this report.

Figure 4-1: SGIPce Model Flow

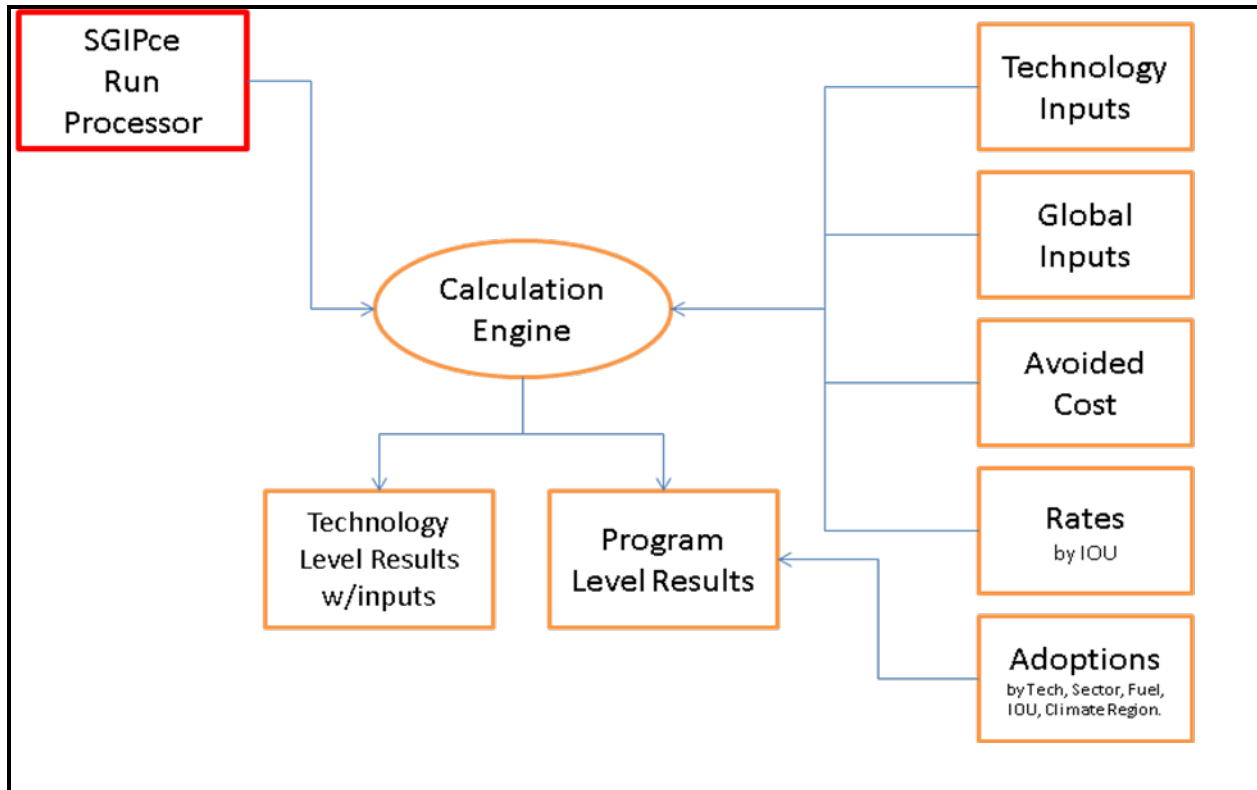

4.4.1 Components

SGIPce Run Processor

The entire SGIPce system is comprised of a series of Excel 2007 workbooks. These workbooks contain data and code that are used to implement the calculations needed to evaluate the cost-effectiveness of the technologies defined in the system. The SGIPce Run Processor, represented in Figure 4-1 as a red rectangle, is the control panel for the system. It is where the user starts the system and where the user defines the technologies to be included in a run. Once the technologies are selected and the parameters are set then a run is defined. The user presses a processor button that calls routines in the Calculation Engine and the batch process begins.

When the batch process is started a series of steps is performed by the code to develop the desired results. Figure 4-1 presents a number of gold rectangles to the right representing the

supporting workbooks that have been defined for use in the system. As mentioned before, each of these workbooks contains inputs for the model. The system is designed to retrieve the inputs from the appropriate workbooks and place them into the Calculation Engine represented by the gold oval in the center of the figure. Once these data are installed in the Calculation Engine, code in the engine is started that calculates the inputs to the cost-effectiveness functions and stores the resultant data in a workbook.

At the bottom of Figure 4-1 are two gold rectangles representing the data stored in the Results workbook(s) generated during the batch run. The inputs to the cost-effectiveness calculations are stored as technology-level results in the Results workbook. These technology-level results are then weighted by Adoptions to calculate Program-Level Results also stored in the Results workbook. As explained in the User Guide, the Results workbook can be created as one workbook with all the results or can be generated by utility. Either way, the outcome is the same. All the inputs generated by the Calculation Engine are stored in the workbooks and the resultant cost-effectiveness calculations are generated.

Input Workbooks

As mentioned before, the Input workbooks are a set of workbooks that supply data to the model. Each of these workbooks contains information needed by the model. They are standalone workbooks with no links to any other workbooks. The data that are used in these workbooks are identified using range names so that the code knows where to find the data needed to populate the Calculation Engine. In general, the cells with either yellow or melon backgrounds are the cells that are used by the system as inputs to the calculations.

Calculation Engine

The Calculation Engine is the heart of the system. The vast majority of the code used to run the simulations resides in this workbook. The Run Processor is where the system is started but it passes control to this workbook very early on to complete the calculations. It is this workbook that is responsible for gathering the data for each item in the batch run. Once the inputs are populated this workbook runs the code that generates and stores the results. It also controls the code that creates, populates, and saves the Results workbooks upon completion of the run.

As with all the workbooks there are a number of tabs in the Calculation Engine. This workbook was started using the latest E3 CSI ProForma model. Most of the user interface was replaced by the batch processor being described in this document, but the LCOE worksheet in this model is the basis for the calculations. With modifications to deal with the CHP technologies the LCOE worksheet remains intact. The worksheets and code added to this workbook were designed to replace the user interface with input worksheets and a place to store the results after each

iteration of the model. The User Guide goes into more detail about what the tabs in this workbook do and how they support the system.

Results Workbooks

The Results workbook starts as a template. The system makes one or more copies of this template based on how the user has specified the way the results are to be stored. The user has the choice of storing all the results in one workbook or may segregate the results by utility if desired.

The workbook is comprised of a number of tabs. They fall into three categories. The first is the tab that holds adoptions. The Adoptions tab holds the entire compliment of adoptions for all combinations of technologies. These values come from a workbook of adoptions stored in the inputs folder. These values are used to weight the individual technology estimates so that they can be aggregated by the system. The second set of tabs hold the technology-level results and the summary of results weighted using the adoptions. The final set of tabs consists of a Template tab and one tab for each technology combination run during the batch process. The system makes a copy of the Template tab, renames the tab based on the current technology, and pastes in the results from the Calculation Engine used to generate the results for that technology combination.

4.4.2 Functionality

The system was designed using Microsoft Excel so that the user would have the ability to see the calculations being performed within the system. At every step of the way the user may peer into the workings of the system to see how a calculation is being performed and from where the data are coming. If the user so chooses, they can save the Calculation Engine for each technology combination that is run during the batch process. These copies of the Calculation Engines allow the user to view all the calculations that went in to estimating the inputs to the cost-effectiveness functions.

Along with the ability to view all the calculations, the user may change inputs to all calculations in many ways. First, the user can select different inputs for each technology line item when defining the batch run. Parameters available in the List of Technologies include:

- Technology,
- Utility,
- Sector,
- Fuel Type,
- Climate Region,
- Utility Rate,
- Financing Option,
- Rebate Type, and
- Progress Ratio.

The user may also select whether the current batch run will use the Base Case or the Greenhouse Gas (GHG) set of assumptions built into the model.

If these inputs are not sufficient to specify the desired scenario then the user may open the individual input workbooks and make changes directly to the default inputs, allowing them to specify any scenario imaginable. It is suggested that, if the user is going to change the input workbooks, they make a copy of the original workbooks so that they can return to the default values if necessary.

The results from these newly specified runs will be stored in a new workbook. The default adoptions are copied into the new workbook during the batch run. The user may change these default values as well if desired. The table of adoptions found in the Results workbook is editable, and new values copied into this tab will be automatically applied to the technology-level results to generate new aggregate results of the cost-effectiveness calculations.

The bottom line is that the cost-effectiveness model is very flexible and transparent to the user. Any or all inputs may be changed by the user in an effort to specify their scenarios of choice.

4.4.3 Inputs

Figure 4-1 shows graphically the input workbooks on the right-hand side of the flowchart. The following section walks through each of the boxes describing the data contained in each of these input workbooks.

Technology Inputs

This box represents a set of workbooks that define the inputs for all technologies available in the system. There is one workbook for each technology, size, sector, and type of fuel. In the case of the ORC, PV, Storage, and Wind technologies the fuel type is not considered. These workbooks have a corresponding set of line items in the Run Processor allowing the user to specify other characteristics about them to more accurately define the desired run criteria.

The Technology Input workbooks define all aspects of the technology data necessary to run a technology in the system. The inputs include global technology-level data (*Constants*) that do not change over time like system size, degradation, emissions, etc. The workbooks include annual inputs (*AnnualInputs*) that have a time component to them, such as system installation costs, rebates, and operating and maintenance costs. Also defined in the technology workbooks is the level of production (*TechnologyProduction & ProductionCurves*) expected from the system for each hour of the year (i.e., 8,760 hours per year).

The system retrieves the technology-level data from the Technology Input workbooks. There are, however, a number of supplementary worksheets in the technology workbooks. These worksheets should be considered working papers used by the engineers who developed the data for each technology. The supplemental tabs document the sources of data used and are referenced by the Technology Input worksheet.

Global Inputs

This box represents a workbook that contains data used by all technologies. Included in this workbook are data for various financing options having a time component, global inputs that are also time-dependent, and global inputs that are not time-dependent.

Avoided Cost

The Avoided Cost box in Figure 4-1 represents four workbooks that contain the electric and gas avoided costs. The electric avoided costs are stored in a workbook that holds the values by utility and climate region (i.e., coastal and inland) and for the base case and high cost scenario of avoided cost. The high cost scenario is used in the calculation of the GHG scenario. The avoided costs are sets of 8,760 values based on the 2009 calendar and span the period from 2008 through 2040. These values were derived from the E3 electric and gas avoided cost workbooks

that were developed for the SGIP.³ To calculate the model inputs for the avoided cost benefits, the production curve for the current technology is supplied to the workbook and the production curve and the yearly 8760 avoided cost values are multiplied, leading to the calculation of a stream of annual values that are then supplied to the calculation engine.

For the gas avoided costs, the data are similar in nature to the electric avoided costs with the following differences:

- The gas avoided costs differ by sector and are aggregated to a monthly level.
- The gas avoided costs are developed by sector because the GHG emissions differ by the underlying technology (boiler vs. furnace).
- The gas avoided costs are not provided at the 8760 level because gas consumption and heat usage is only monitored monthly; therefore the avoided costs are supplied at that level.
- The gas avoided costs span the same period as the electric avoided costs.
- Two production curves are supplied to the workbook: therms required to fuel the CHP DG technology and therms saved from capturing the heat from the CHP DG technology. As expected, two streams of values are calculated from these production curves and supplied back to the calculation engine, one for each production curve.

A set of gas avoided costs were also developed using only the transmission and distribution components of the benefits. These values are needed for non-core customers when calculating the Program Administrator Cost Tests.

Rates

The Rates box in Figure 4-1 represents a number of workbooks designed to supply utility rate information to the system. Rates are defined for the residential and non-residential sectors. Due to the complex nature of rates, the non-residential rates are defined in separate workbooks for each utility and rate defined. For the residential sector it was possible to combine all rate definitions into one workbook. There is also a third workbook that defines the gas rates for the non-residential sector. The non-residential gas rates workbook provides rates from non-core gas customers with a reduced transmission and distribution fee for CHP gas required to run the DG measures. This workbook also provides the rate information, with the standard transmission and distribution fee, for the valuation of the natural gas saved from capturing the heat generated by the CHP DG measure.

³ The exact E3 avoided cost workbooks were labeled SGIP_2009ElecAvoidedCostModule_5-4-2010 and SGIP_GasAvoidedCostModule.

The structure of the rates workbooks are similar in nature to the avoided cost workbooks in that the electric workbooks are defined for 8,760 hours over the entire possible lifetime of the technologies (in this case 2007 to 2040). The technology production curve is supplied to the workbook and a stream of annual values is provided to the calculation engine. For the rates, however, there is a secondary set of worksheets that define the rates. These worksheets are used to calculate the vast number of values needed for the yearly calculation based on production. The structure of these workbooks will be discussed later.

It should be noted that due to the tremendous number of calculations the link between the secondary worksheets and the main worksheet for the non-residential rate was broken to help minimize the calculation time during the batch runs. A separate workbook with all calculations has been maintained in the event that changes are needed or new rates are desired for future runs.

Both the gas avoided cost workbook and the non-residential gas rates workbook are defined at the monthly level. The quantity of natural gas required to fuel the DG technology and the natural gas savings from heat capture are supplied to the workbook in monthly values. The rates workbook multiplies the gas needed and the gas saved by the appropriate rates and then provides the calculation engine with the value of the net increase in gas consumption.

The residential workbook contains both gas and electric rates in one workbook. The workbook contains two worksheets that aggregate the data needed by the system and uses the other supplementary worksheet to calculate the appropriate rates given the utility and rate defined by the user for the technology. For the residential rate it was possible to preserve the calculations without degrading the speed of the system.

Adoptions

The Adoptions box in Figure 4-1 represents a single workbook that supplies adoptions data to the results workbook upon completion of each batch run. Adoptions in this workbook have been defined for every combination of technologies possible. The adoptions are defined annually and span from 2007 through 2020.

4.4.4 Outputs

The model outputs data at both the technology and program level. The cost-effectiveness calculations are performed at the technology level. The adoption inputs are incorporated to allow for the aggregate calculation of the cost-effectiveness inputs and test values across technologies, sectors, and for the overall portfolio of technologies.

Included in these outputs and results are the following:

- Levelized Lifetime Values of all inputs to the calculation of the LCOE.
- Values are generated using discount rates at the Participant, Societal, and Utility level.
- The values are stored at the technology combination level which is defined by the user to include a technology, sector, fuel type, utility, climate region, utility rate, financing option, and type of rebate.
 - A map of the climate regions can be seen in Figure 4-2.
- From these values, the components of the various benefit/cost test are calculated.
- The application of adoptions allows for the calculation of the tests at the technology, sector, and overall levels.
- The program-level results list the program-level benefits and costs, the energy savings, and the rebates included in the model.

Figure 4-2: Climate Regions in California

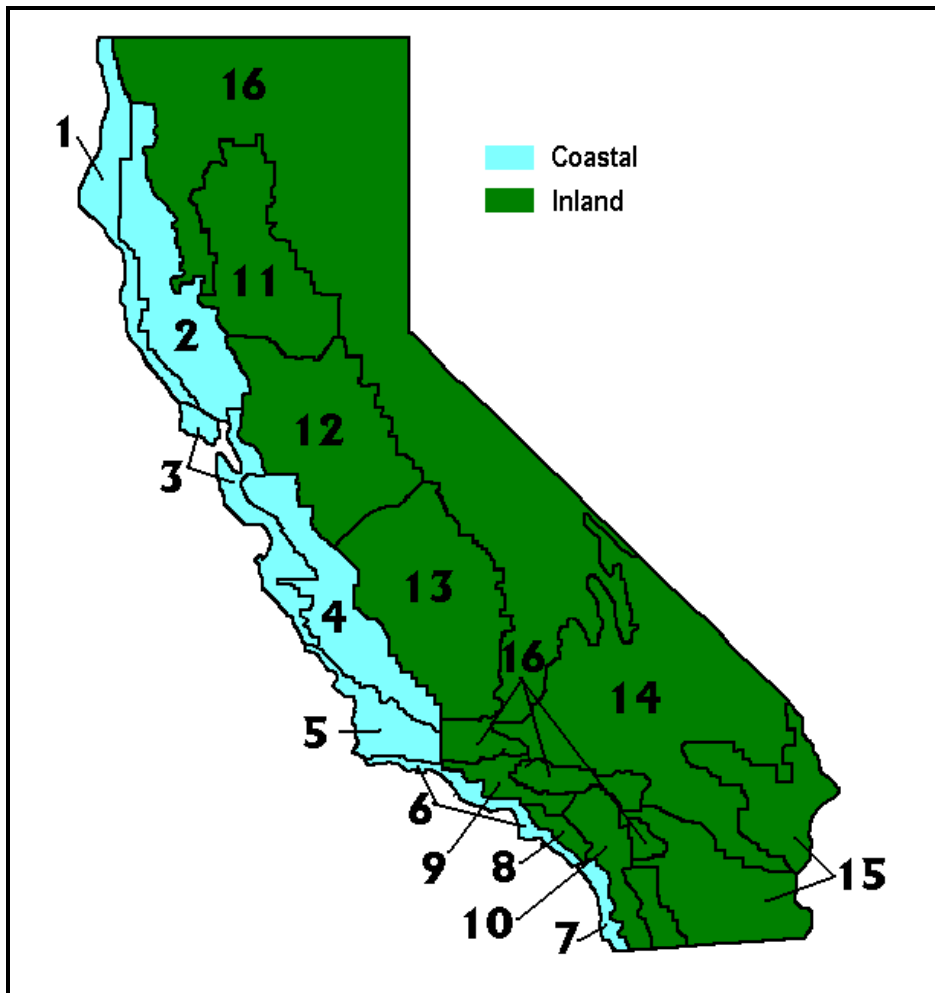

Program- and Technology-Level Results

The program-level results are stored in one or more workbooks per batch run. The results are stored in more than one workbook if the user chooses to store the results by utility, a selection that can be made when defining the run. If selected a workbook is created for each utility selected. If, however, the user does not choose to segregate the results by utility then all results are stored in a single workbook.

The Results workbook consists of many worksheets. The cover sheet lists the user-defined global parameters. The Adoption worksheet lists adoptions for all possible technology combinations. The Summary Stats per Unit worksheet list of technologies included in the run and the per unit values of the benefit/cost test components. The Summary Stats Total worksheet combines the per unit-level results with adoptions to aggregate the cost-effectiveness results by technology group, sector, and total. Finally, there are worksheets for each technology that was included in the batch run. These worksheets correspond directly to the Results worksheet found in the Calculation Engine workbook and are used by the Summary Stats per Unit and the Summary Stats Total sheets to gather data for all technology combinations in the batch run.

Viewing Calculation Engine and Results

If the user chooses to “Save Calc for each line”, upon completion of the run, the Calculation Engine and the results from each run are stored in the appropriate workbook(s). If the user chose to not Save Calc for each line, upon completion of the run, the results from each run will be stored and the Calculation Engines will not be created. If the user chooses to “Store Results by Utility?” the results will be segregated by utility with a separate Results workbook being created for each utility defined in the run. If this option is not chosen, only one Results workbook is created to hold all the results from the batch run.

All Results workbooks are stored in the sub-directory named *Results* just below the SGIPce workbook. The user has the option to store the workbooks in other locations if they choose. They may also rename the workbooks if so desired. The only way this is made available to the user, however, is when the *Batch Process View Screen Updating* button is pressed. The other two run buttons automatically save the Results workbooks with their default names.

There is a control named Update/Replace Results on the opening screen in SGIPce. The purpose of this control is to tell the system to either completely replace any currently saved results with the new ones being run (*No*) or to update or replace results that currently exist (*Yes*). If set to *No* then the Results workbook is overwritten with a new one. If this control is set to *Yes*, however, the system treats results much differently. First the system looks to see if a Results workbook already exists with the same name as defined by the user for this run. If it does then the system opens that workbook as the data store for the current run. If it does not then it creates a new

workbook for results. As the batch process proceeds and results are ready to be stored the system looks in the Results workbook for previously stored results. If they exist then they are replaced. If they do not exist then they are added as a new worksheet. No Results worksheets are deleted from the Results workbook when this flag is set. This feature can be used to fix existing results without the need to run the entire list of technologies, and new technologies may be added again without the need to run the entire list of technologies as well.

5

Results and Observations

Cost-effectiveness of distributed generation (DG) technologies is determined in accordance with tests developed under the modified standard practice manual approach outlined in Decision 09-08-026. Three tests are used in this study: the societal version of the Total Resource Cost test (STRC), the Participant test (PCT), and the Program Administrator (PA) test. The STRC looks at the overall cost-effectiveness of DG technologies to society. The CPUC has directed that only DG technologies in which the societal benefits outweigh societal costs will be eligible for incentives. The PCT examines the cost-effectiveness of the DG technology to the participant. If costs outweigh benefits, the technology is not cost-effective to the participant. The PCT can be used to help design an approach on incentives to be paid to the participant. The PA test identifies the cost-effectiveness of the DG technology to the PAs. The following sections present the STRC, PCT, and PA test results.

5.1 Societal TRC Results

The STRC looks at the cost-effectiveness of DG technologies from society's point of view. The SGIPce model generates STRC results for all the examined DG technologies from 2009 through 2020. However, the STRC results for two years during this time period are of particular importance: the current year (2010) and (2016). The value of the STRC in 2010 determines the current cost-effectiveness of the technology. The value in 2016 determines the cost effectiveness of the technology in the year the SGIP is designated to expire.

Table 5-1 is a summary of the combined IOU-specific and statewide STRC results for 2010 and 2016 by DG technologies deployed in the commercial sector.¹ SGIPce generates STRC results not only by DG technology but also by electric IOU territory², sector (e.g., commercial, residential, or government/non-profit) and geographical region ("coastal" and "inland"). The

¹ The STRC was calculated without an incentive. Incentives are considered transfer payments that do not impact the TRC. Because rebates are federally taxable income and the Decision stated that the cost-effectiveness models must include the federal tax implications, state incentives have an impact on the cost effectiveness due to the federal tax implications. The cost-effectiveness results in Table 5-1 were evaluated without incentives to determine the cost-effectiveness of the technologies on an equal footing, the cost-effectiveness without any rebate tax benefits.

² The SGIPce model does not generate results for the Southern California Gas (SCG) service territory even though SCG is very active in the SGIP. Due to way in which core and non-core gas costs and prices are handled in SGIPce, it was not possible for the model to generate comparable gas-based cost-effectiveness results for SCG.

statewide results in Table 5-1 represent averages across IOU service territories for California's three largest electric IOUs. The results are averaged in two different ways. First, the results are averaged arithmetically (equally) among the three electric IOUs. Second, the STRC results are averaged based on 2010 electricity sales among the three electric utilities.³ Note that the results in Table 5-1 reflect only the commercial sector; results for the residential and non-profit/governmental sectors are provided in Appendix C.

According to the Standard Practice Manual, a technology is cost-effective from society's point of view if the STRC is greater than 1.0. A STRC value of less than 1.0 implies that the expected costs of the technology exceed the expected benefits. Given the degree of uncertainty in the forecast of avoided cost benefits over the 20-year life of a DG technology, the point estimate values provided in this section should be viewed as best forecasts of the measure's cost-effectiveness.

³ Electricity sales for the three electric IOUs are approximately 45% for PG&E, 45% for SCE and 10% for SDG&E

Table 5-1: Statewide Summary of Commercial Sector Societal TRC Results for 2010 and 2016, No Incentives

Technology	System Size (kW)	PG&E		SCE		SDG&E		Statewide Equalized		Statewide Elec. Sales Wgtd.	
		TRC - 2010	TRC - 2016	TRC - 2010	TRC - 2016	TRC - 2010	TRC - 2016	TRC - 2010	TRC - 2016	TRC - 2010	TRC - 2016
Wind Turbine											
1 MW nonresidential/government	1,000	1.39	1.70	1.41	1.73	1.40	1.72	1.40	1.72	1.40	1.72
Fuel Cell - Electric Only											
Natural gas	1,200	0.91	1.01	0.92	1.02	0.94	1.04	0.92	1.02	0.92	1.01
On-site biogas	1,200	0.86	1.00	0.87	1.01	0.88	1.03	0.87	1.01	0.87	1.00
Directed biogas	1,200	0.93	1.04	0.94	1.05	0.96	1.07	0.94	1.05	0.94	1.04
Fuel Cell - CHP (i.e., w/waste heat recovery)											
Natural gas powered	1,200	1.03	1.14	1.04	1.15	1.07	1.18	1.05	1.16	1.04	1.15
On-site biogas	1,200	1.01	1.18	1.01	1.19	1.03	1.22	1.02	1.20	1.01	1.19
Directed biogas	1,200	1.06	1.18	1.07	1.19	1.10	1.22	1.08	1.20	1.07	1.19
Gas Turbine - CHP											
Natural gas powered (1000 kW)	1,000	0.87	0.87	0.88	0.88	0.91	0.91	0.89	0.89	0.88	0.88
On-site biogas (1000 kW)	1,000	0.88	0.92	0.89	0.93	0.91	0.95	0.89	0.93	0.89	0.93
Directed biogas (1000 kW)	1,000	0.94	0.95	0.96	0.96	0.98	0.98	0.96	0.96	0.95	0.96
Natural gas powered (3500 kW)	3,500	1.08	1.09	1.10	1.10	1.13	1.13	1.11	1.11	1.10	1.10
On-site biogas (3500 kW)	3,500	1.16	1.22	1.17	1.23	1.20	1.26	1.18	1.24	1.17	1.23
Directed biogas (3500 kW)	3,500	1.15	1.16	1.17	1.17	1.20	1.20	1.17	1.18	1.16	1.17
Microturbine – CHP											
Natural gas powered	200	1.04	1.05	1.05	1.07	1.09	1.10	1.06	1.07	1.05	1.06
On-site biogas	200	1.24	1.52	1.24	1.52	1.26	1.54	1.25	1.53	1.24	1.52
Directed biogas	200	1.12	1.14	1.13	1.15	1.17	1.18	1.14	1.16	1.13	1.15
IC Engine - CHP											
Natural gas powered (500 kW)	500	1.20	1.21	1.22	1.23	1.26	1.27	1.23	1.23	1.21	1.22
On-site biogas (500 kW)	500	1.82	2.39	1.82	2.40	1.85	2.43	1.83	2.40	1.82	2.39
Directed biogas (500 kW)	500	1.27	1.29	1.29	1.30	1.33	1.34	1.29	1.31	1.28	1.30
Natural gas powered (1500 kW)	1,500	1.28	1.29	1.30	1.30	1.34	1.34	1.31	1.31	1.29	1.30
On-site biogas (1500 kW)	1,500	1.50	1.70	1.50	1.72	1.55	1.77	1.51	1.73	1.50	1.72
Directed biogas (1500 kW)	1,500	1.35	1.37	1.37	1.39	1.42	1.43	1.38	1.39	1.37	1.38
Organic Rankine Cycle											
	500	1.52	1.71	1.53	1.73	1.57	1.78	1.54	1.74	1.53	1.73
Storage											
Med storage	25	0.51	0.60	0.50	0.58	0.49	0.57	0.50	0.58	0.50	0.59
Larger storage	1,000	0.57	0.68	0.56	0.66	0.53	0.62	0.55	0.65	0.56	0.66

As shown in Table 5-1, most DG technologies pass or are very close to passing the STRC test in either 2010 or 2016 under the Base Scenario.⁴ Exceptions include medium or large storage, and gas turbines in the 1,000 kW size range fueled by natural gas, on-site biogas, or directed biogas. Descriptions of all of the technologies evaluated in the SGIPce model can be found in Appendix A.

In order to better understand the STRC results, it is helpful to consider the results grouped by combinations of technologies and fuels. Generally, fuel types can be grouped by the following categories:

- Non-combustion-sourced fuels (e.g., wind, storage, ORC)
- Natural gas-sourced fuel
- Directed biogas-sourced fuel
- On-site biogas-sourced fuel

5.1.1 Non-Combustion-Related Fuel Results

Figure 5-1 shows the statewide societal TRC results for non-combustion-sourced fuel DG technologies in 2010 and 2016 without incentives.⁵ The dark bars reflect the STRC test results for non-combustion-sourced fuel technologies at 2010, while the light bars are the STRC results in 2016. The solid horizontal line on the chart (at an STRC benefit-to-cost ratio value of 100%) represents the threshold typically used for determining if the measure passes the STRC test. However, the STRC results include some uncertainty. Consequently, a dotted horizontal line is drawn at an 80% benefit-to-cost ratio to indicate the STRC results against a lower threshold. The large uncertainty bound is due in part to the relatively high uncertainty associated with utility rate and avoided cost forecasts. DG technologies are long-lived measures, necessitating a 20-year rate and avoided cost forecast from the year of the measure's installation. Changes in the availability of resources, the valuation of greenhouse gases (GHG), and macroeconomic outcomes (recessions and expansions) can have significant impacts on the realized value of rates and avoided costs in the future.⁶

⁴ The Base Scenario uses the mid avoided cost scenario, the mid forecast of the value of GHG from the E3 avoided costs, and a capacity factor of 0.80 for all DG technologies other than wind and storage.

⁵ STRC results are only shown for the commercial sector and for the representative "inland" weather condition locations.

⁶ High uncertainty bounds are not unheard of in cost-effectiveness analysis. The California Statewide Potential Study (2007) uses a TRC test of 85% to determine eligibility for program rebates. In general, the uncertainty of energy efficiency measures may be less than the uncertainty of DG technologies due to the shorter expected useful life of energy efficiency measures when compared to DG measures.

Figure 5-1: Statewide Societal TRC Results by Non-Combustion Fuel Type (2010 and 2016), No Incentives

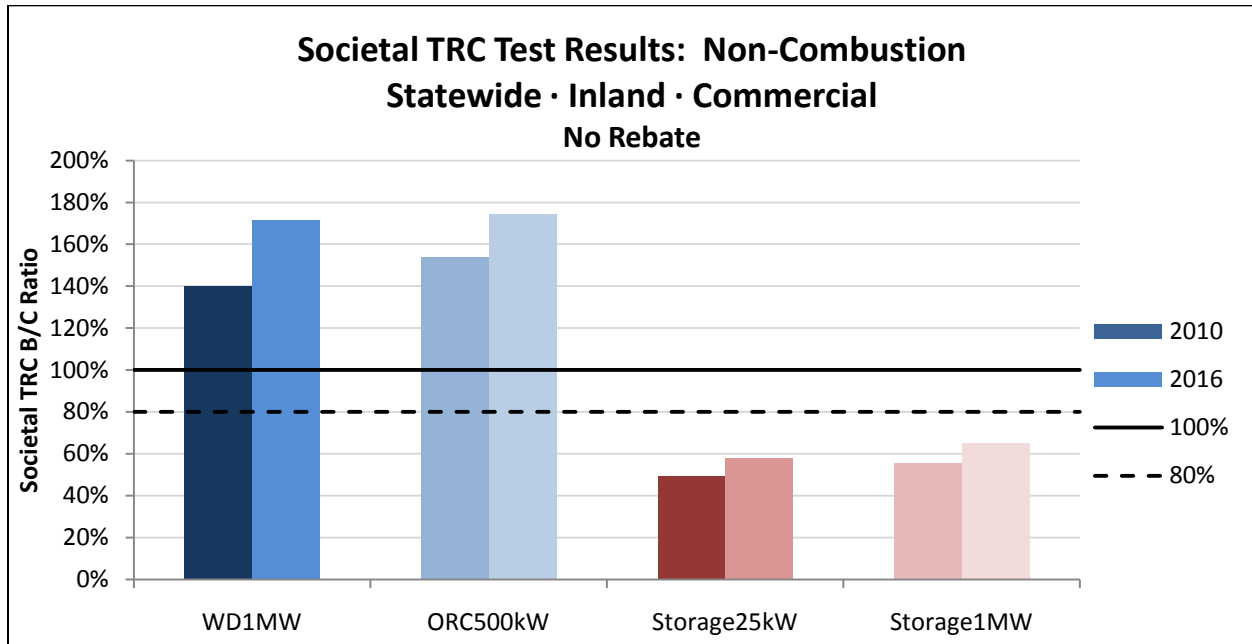

Both ORC and wind pass the STRC test by significant margins in 2010 and 2016. Storage, both at the 25 kW and 1 MW size ranges, fails to pass the STRC. Table 5-2 lists and Figure 5-2 illustrates the cost and benefit components making up the STRC results for wind (1 MW), ORC (500 kW), storage (25 kW), and storage (1 MW). The values are specific to STRC results examined at 2010, within PG&E, and only for the commercial sector.⁷

⁷ The emission benefits associated with foregoing electricity produced at a central power plant and using electricity produced from non-combustible DG technologies is included in the avoided cost benefits.

Table 5-2: STRC Test Levelized Cost and Benefits for Non-combustible DG Technologies, PG&E Territory, No Rebate, 2010

2010	Wind (1 MW)		ORC (500 kW)		Storage (25 kW)		Storage (1 MW)	
	Benefit	Cost	Benefit	Cost	Benefit	Cost	Benefit	Cost
System Cost	\$0	\$185,530	\$0	\$255,450	\$0	\$16,143	\$0	\$400,444
Federal Taxes	\$93,724	\$0	\$115,063	\$0	\$7,408	\$0	\$213,229	\$0
Avoided Cost	\$215,119	\$0	\$336,517	\$0	\$4,005	\$0	\$127,446	\$0
O&M Cost	\$0	\$37,179	\$0	\$40,264	\$0	\$3,831	\$0	\$95,041
Fueling Cost	\$0	\$0	\$0	\$0	\$0	\$2,475	\$0	\$98,983
Emissions	\$0	\$0	\$0	\$0	\$0	\$0	\$0	\$0
Total	\$308,843	\$222,708	\$451,580	\$295,714	\$11,413	\$22,449	\$340,674	\$594,468
Net Benefit	\$0	\$86,135	\$0	\$155,866	\$0	-\$11,035	\$0	-\$253,794
Ratio		1.39		1.53		0.51		0.57

Note: The STRC does not include the rebate, REC revenue, state taxes, or avoided bills so these potential costs and benefits are not included in the table. With rebates zero, there is no program, so the PA costs are zero and not included in the table.

Figure 5-2: STRC Levelized Cost and Benefit Components for Non-combustible DG Technologies, PG&E Territory, No Rebate, 2010

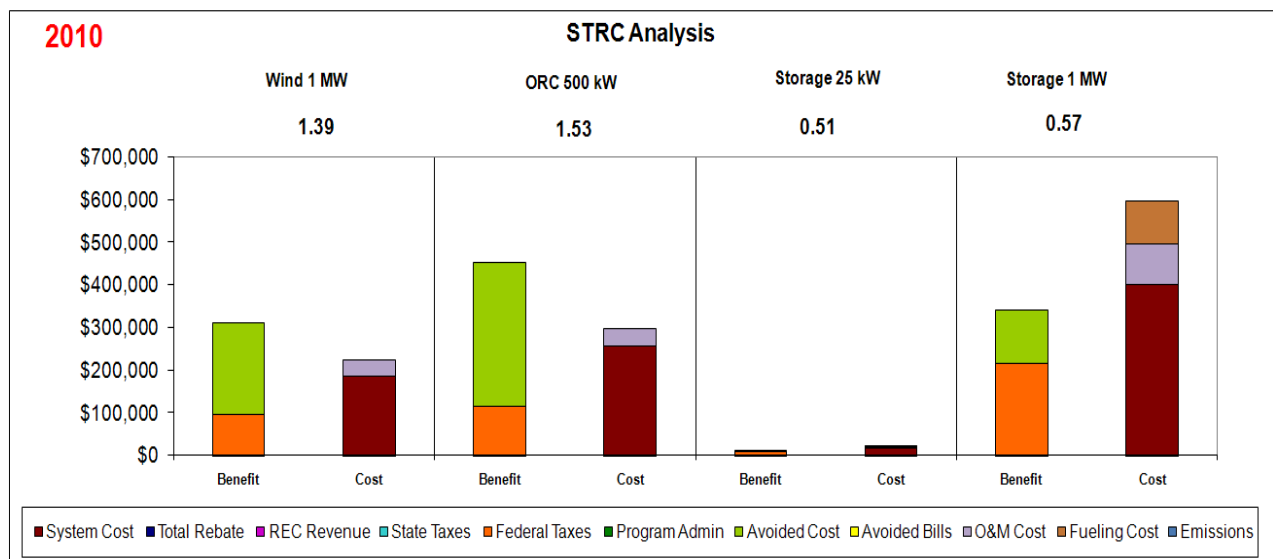

The results in Figure 5-2 help to explain why storage technology is not cost-effective while both wind and ORC pass the STRC test. First, the system cost for storage is high relative to the system cost of wind or ORC while the avoided cost benefits from storage are lower than the avoided cost benefits from wind or ORC. In addition, storage must pay a fueling or charging costs while wind and ORC receive their power from free sources.

Storage, as modeled in the Base Scenario, relies on price arbitrage to create value. Storage is modeled to charge batteries during the low cost period of the night (over a five-hour time period) and discharge to the facility during the high cost peak period (over a four-hour time period). The low and high cost periods are valued in the STRC according to the E3 avoided costs. For storage to be cost-effective, the value of the high cost period must be substantially higher than the value of the charging period and there must be enough high cost periods during the year. Figure 5-3 illustrates the hourly values of the avoided cost for PG&E in climate zone 3. The avoided cost values have been sorted to help illustrate that, while the 8,760 of avoided costs include very high hourly valuation for energy, the number of hours with extremely high energy values is relatively low. Storage is not cost-effective because there are not enough high value hours to overcome the high cost of the storage measure.

Figure 5-3: Hourly Avoided Cost Values for PG&E Climate Zone 3 in 2010

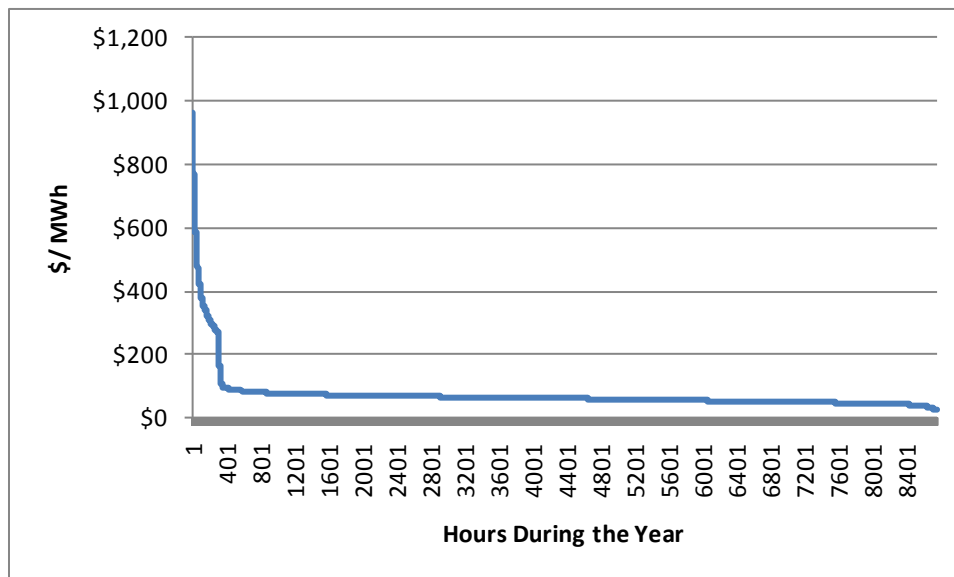

5.1.2 Natural Gas-Fueled Results

Figure 5-4 illustrates the statewide Base Scenario STRC results for DG technologies fueled by natural gas in 2010 and 2016 without incentives. Table 5-3 and Figure 5-5 present the breakdown of the STRC results for PG&E natural gas-fueled technologies in 2010, without a

rebate.⁸ The statewide STRC results provide an illustration of cost-effectiveness and how cost-effectiveness changes over time, while the breakdown of the cost-effectiveness test into the individual components provides information on the size of cost and benefit components and their influence on the measure's cost-effectiveness.⁹

Under the Base Scenario, which assumes that the capacity factor is approximately 80% for all natural gas-fueled technologies, all DG technologies fueled by natural gas pass a minimum benefit-to-cost ratio test of 0.8 for both 2010 and 2016.¹⁰ The results illustrated in Figure 5-4 show that the STRC test values for most natural gas-fueled technologies do not vary significantly between 2010 and 2016. Fuel cells, both electric only and CHP fuel cells, are the only natural gas-fueled technology that shows a visible increase in the STRC between 2010 and 2016. The increase in the STRC for fuel cells is due to the more rapid fall in the cost of fuel cell technology relative to the other technologies. Fuel cells are a relatively new or emerging technology when compared to turbines or internal combustion (IC) engines, which are mature technologies. Newer technologies are forecast to have a lower progress ratio or a larger fall in their costs over time than mature technologies (see the discussion on learning curves in Section 3).

⁸ The STRC results for PG&E are very similar to the results for SDG&E and SCE. The presentation of these results is intended to illustrate the cost and benefit breakdown for all utilities analyzed in this evaluation.

⁹ The emissions benefit associated with not using electricity produced from a central power station are included in the avoided cost benefits. The emissions costs associated with fueling DG technologies with natural gas are explicitly listed as a cost in Figure 5-5 and Table 5-3.

¹⁰ The inputs for the STRC for any given technology encompass over 20 years of data. These data include the future value of the cost of the technology, the future value of avoided electric and gas costs and benefits, the future value of avoided green house gas emissions and future programs costs. Given the uncertainty in these future estimates, and the desire to implement a program that helps with the program goals of market transformation, considering measures with STRCs between 0.8 and 1.0 may be consistent with the program objectives.

Figure 5-4: Statewide Societal TRC Results by Natural Gas Fuel (2010 and 2016), No Incentives

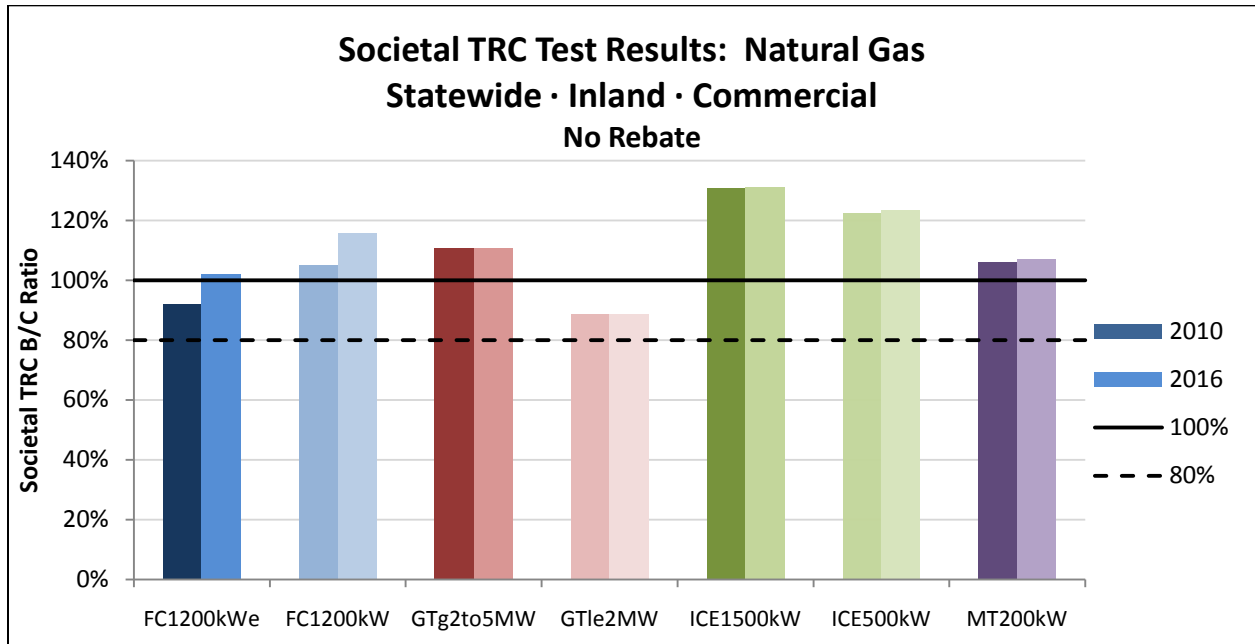
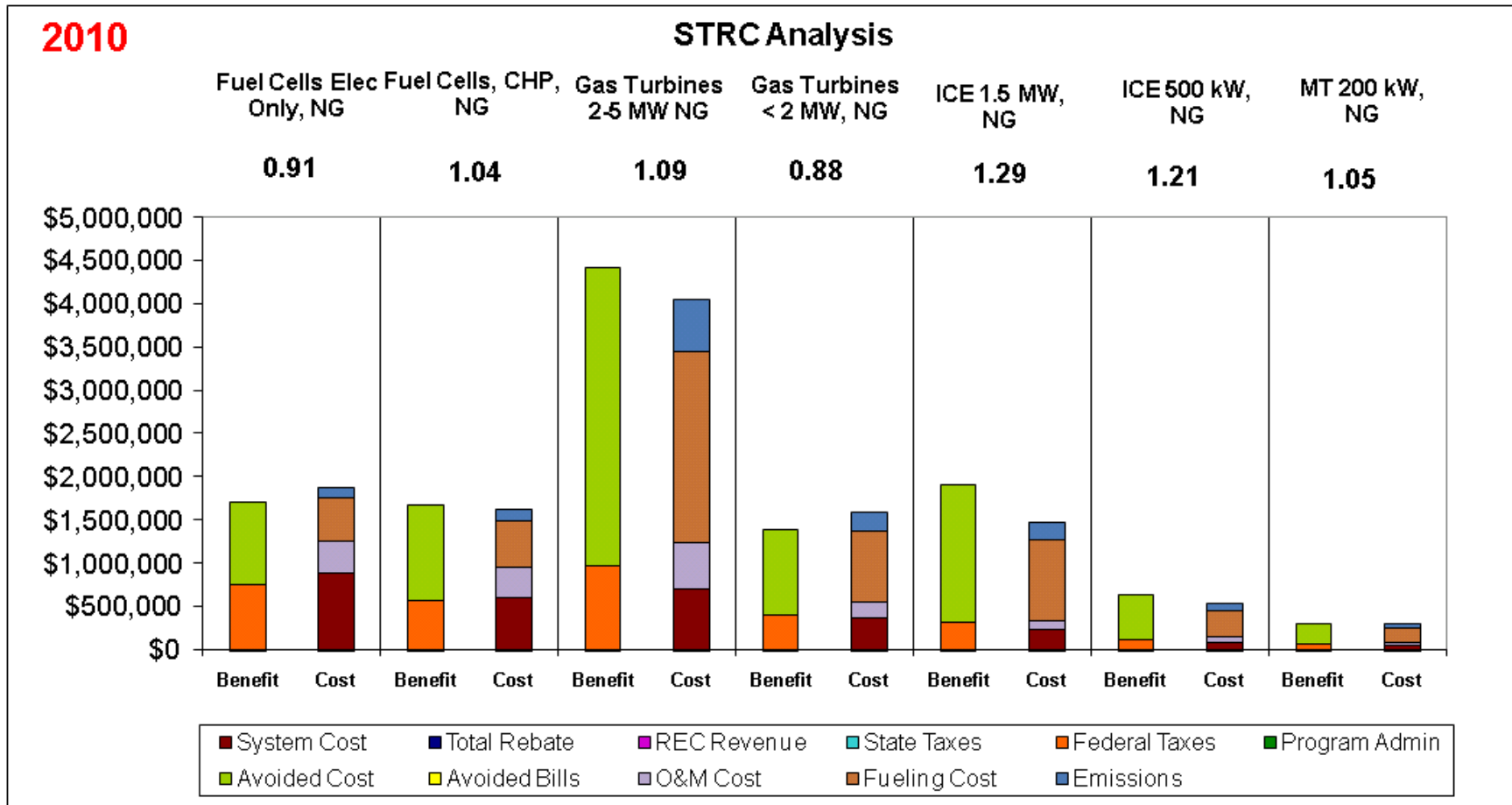

Table 5-3: STRC Test Levelized Costs and Benefits for Natural Gas Technologies, PG&E Territory, No Rebate, 2010

2010	Fuel Cells-Elec Only (1.2 MW)		Fuel Cells (1.2 MW)		Gas Turbine (>2-5 MW)		Gas Turbine (≤ 2 MW)		IC Engines (1.5 MW)		IC Engines (500 kW)		Microturbine (200 kW)	
	Benefit	Cost	Benefit	Cost	Benefit	Cost	Benefit	Cost	Benefit	Cost	Benefit	Cost	Benefit	Cost
System Cost	\$0	\$894,230	\$0	\$612,365	\$0	\$711,781	\$0	\$365,250	\$0	\$235,935	\$0	\$91,758	\$0	\$55,311
Federal Taxes	\$765,677	\$0	\$572,621	\$0	\$973,264	\$0	\$413,879	\$0	\$330,965	\$0	\$121,495	\$0	\$63,599	\$0
Avoided Cost	\$951,046	\$0	\$1,112,713	\$0	\$3,445,378	\$0	\$984,394	\$0	\$1,581,135	\$0	\$527,045	\$0	\$249,516	\$0
O&M Cost	\$0	\$364,451	\$0	\$344,992	\$0	\$539,152	\$0	\$194,990	\$0	\$101,360	\$0	\$56,070	\$0	\$36,817
Fueling Cost	\$0	\$495,739	\$0	\$538,846	\$0	\$2,195,802	\$0	\$813,260	\$0	\$932,379	\$0	\$310,793	\$0	\$168,346
Emissions	\$0	\$127,361	\$0	\$127,361	\$0	\$609,009	\$0	\$224,158	\$0	\$216,021	\$0	\$78,596	\$0	\$38,909
Total	\$1,716,723	\$1,881,781	\$1,685,334	\$1,623,565	\$4,418,642	\$4,055,744	\$1,398,273	\$1,597,658	\$1,912,100	\$1,485,695	\$648,540	\$537,217	\$313,115	\$299,383
Net Benefit	\$0	(\$165,058)	\$0	\$61,770	\$0	\$362,898	\$0	(\$199,385)	\$0	\$426,405	\$0	\$111,324	\$0	\$13,732
Ratio		0.91		1.04		1.09		0.88		1.29		1.21		1.05

Note: The STRC does not include the rebate, REC revenue, state taxes, or avoided bills so these potential costs and benefits are not included in the table. With rebates zero, there is no program, so the PA costs are zero and not included in the table.

Figure 5-5: STRC Levelized Cost and Benefits for Natural Gas Technologies, PG&E Territory, No Rebate, 2010



The information presented in Figure 5-4, Figure 5-5, and Table 5-3 show that IC engines pass the STRC test by a significant margin regardless of their size, although the larger-sized 1,500 kW system has a slightly higher STRC value than 500 kW systems. The data presented in Figure 5-5 show that the STRC for a 1,500 kW IC engine in PG&E's territory is 1.29 while the STRC for a 500 kW IC engine is 1.21. In this instance, increased electricity and natural gas savings associated with the larger system, along with large federal tax savings, offset the higher cost and operating expenses of the larger engine leading the large engine to have a slightly higher STRC than the smaller engine.

For fuel cell technologies, electric-only fuel cells have a lower STRC ratio (STRC=0.91) than fuel cells employing waste heat recovery (STRC=1.04). The CHP fuel cell costs \$5.87 per Watt in 2010 while the electric only fuel cell is modeled to cost \$8.57 per Watt in 2010. The higher cost of the electric-only fuel cell is combined with a higher electrical efficiency compared to the CHP fuel cell.¹¹ However, the electric-only fuel cell does not have the gas saving benefits due to the utilization of the waste heat that accrues to the CHP fuel cell. The lower system cost of the CHP fuel cells combined with the gas and electric avoided cost benefits lead the CHP fuel cells to have a higher STRC than the electric only fuel cell.

There is a marked difference in the STRC results for gas turbines. The larger 3,500 kW gas turbine (GTg2to5MW) has a STRC ratio under the Base Scenario in PG&E territory of 1.09. In contrast, gas turbines sized at 1,500 kW (GTle2MW) have a STRC ratio of 0.88. The gas and electric avoided cost benefits of the larger system more than make up for the larger system and fueling costs of the 3,500 kW turbine, making the larger turbine more cost-effective than the smaller turbine.

The STRC results for microturbines are more similar to 3,500 kW turbines than the 1,500 kW turbine. Both the microturbine and the larger turbine pass the STRC in 2010 under the Base Scenario. Both the larger turbine and the microturbine have similar ratios for the system costs and the system avoided cost benefits, while the 1,500 kW turbine has a higher system cost relative to the avoided cost benefits, as presented in Figure 5-5.

¹¹ Electric-only fuel cells were modeled using a 50% electrical efficiency, whereas CHP fuel cells were modeled using a 46% electrical efficiency.

5.1.3 Directed Biogas Fuel Results

Figure 5-6 shows the statewide STRC results for DG technologies fueled by directed biogas in 2010 and 2016 without incentives. Figure 5-7 and Table 5-4 present the cost and benefit breakout for the STRC test for the Base Scenario in PG&E’s territory. Not surprisingly, the results for directed biogas are similar to those seen for natural gas.¹² However, technologies fueled by directed biogas have slightly higher STRC values than technologies fueled by natural gas. This is due to the higher federal tax benefits associated with using the more expensive per therm directed biogas. The higher tax benefits are a result of the higher directed biogas fueling costs, which lead to higher business costs and a higher federal tax benefit.

Figure 5-6: Statewide Societal TRC Results by Directed Biogas Fuel (2010 and 2016), No Incentives

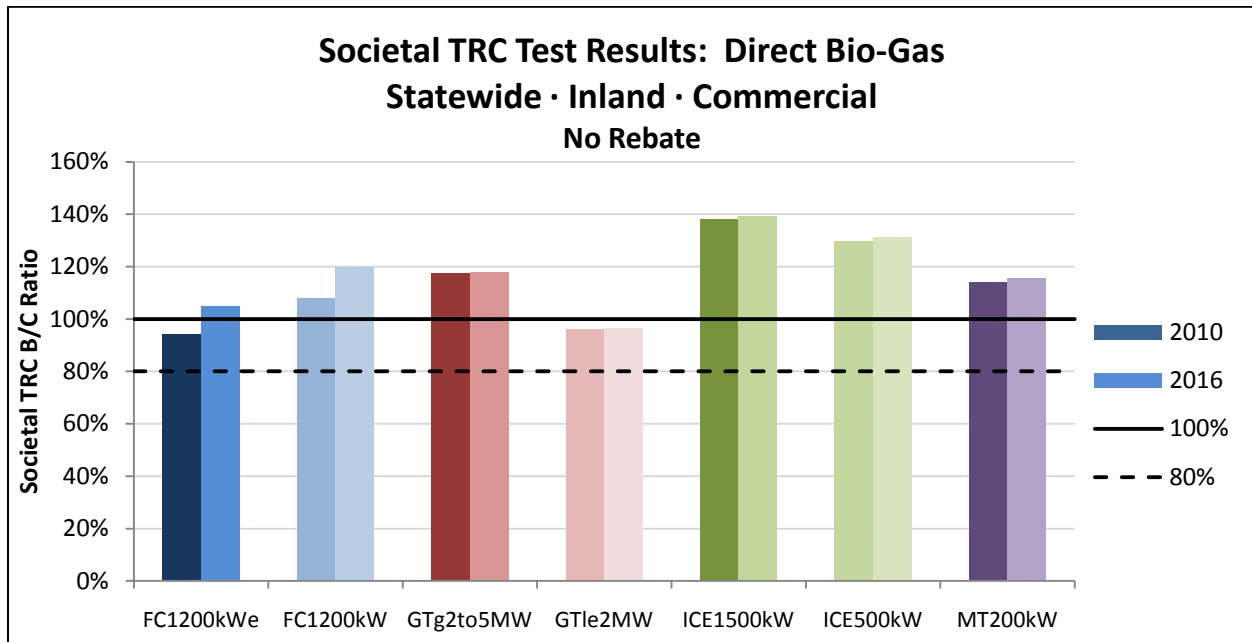

¹² Note that the STRC test does not explicitly incorporate the higher fueling costs of using directed biogas as a fuel since fueling costs and avoided cost benefits are valued at the gas and electric avoided costs not the fuel prices for the STRC test. The higher fueling costs of the directed biogas technologies are incorporated into the federal tax benefits within the STRC test. The actual fueling costs are used to calculate the tax benefits for the STRC test because these are the costs the corporation would use to calculate its taxes. The higher fueling costs directly impact the participant test.

Table 5-4: STRC Test Levelized Costs and Benefits for Directed Biogas Technologies, PG&E Territory, No Rebate, 2010

2010	Fuel Cells Elec Only (1.2 MW)		Fuel Cells (1.2 MW)		Gas Turbine (>2-5 MW)		Gas Turbine (≤ 2 MW)		IC Engines (1.5 MW)		IC Engines (500 kW)		Microturbine (200 kW)	
	Benefit	Cost	Benefit	Cost	Benefit	Cost	Benefit	Cost	Benefit	Cost	Benefit	Cost	Benefit	Cost
System Cost	\$0	\$894,230	\$0	\$612,365	\$0	\$711,781	\$0	\$365,250	\$0	\$235,935	\$0	\$91,758	\$0	\$55,311
Federal Taxes	\$801,332	\$0	\$617,158	\$0	\$1,240,199	\$0	\$528,453	\$0	\$442,139	\$0	\$158,553	\$0	\$87,522	\$0
Avoided Cost	\$951,046	\$0	\$1,112,713	\$0	\$3,445,378	\$0	\$984,394	\$0	\$1,581,135	\$0	\$527,045	\$0	\$249,516	\$0
O&M Cost	\$0	\$364,451	\$0	\$344,992	\$0	\$539,152	\$0	\$194,990	\$0	\$101,360	\$0	\$56,070	\$0	\$36,817
Fueling Cost	\$0	\$495,739	\$0	\$538,846	\$0	\$2,195,802	\$0	\$813,260	\$0	\$932,379	\$0	\$310,793	\$0	\$168,346
Emissions	\$0	\$127,361	\$0	\$127,361	\$0	\$609,009	\$0	\$224,306	\$0	\$216,021	\$0	\$78,596	\$0	\$38,909
Total	\$1,752,378	\$1,881,781	\$1,729,872	\$1,623,565	\$4,685,577	\$4,055,744	\$1,512,847	\$1,597,807	\$2,023,274	\$1,485,695	\$685,598	\$537,217	\$337,038	\$299,383
Net Benefit	\$0	(\$129,403)	\$0	\$106,307	\$0	\$629,833	\$0	(\$84,960)	\$0	\$537,579	\$0	\$148,382	\$0	\$37,656
Ratio		0.93		1.07		1.16		0.95		1.36		1.28		1.13

The STRC does not include the rebate, REC revenue, state taxes, or avoided bills so these potential costs and benefits are not included in the table. With rebates zero, there is no program, so the program administrator costs are zero and not included in the table.

Figure 5-7: STRC Levelized Cost and Benefits for Directed Biogas Technologies, PG&E Territory, No Rebate, 2010

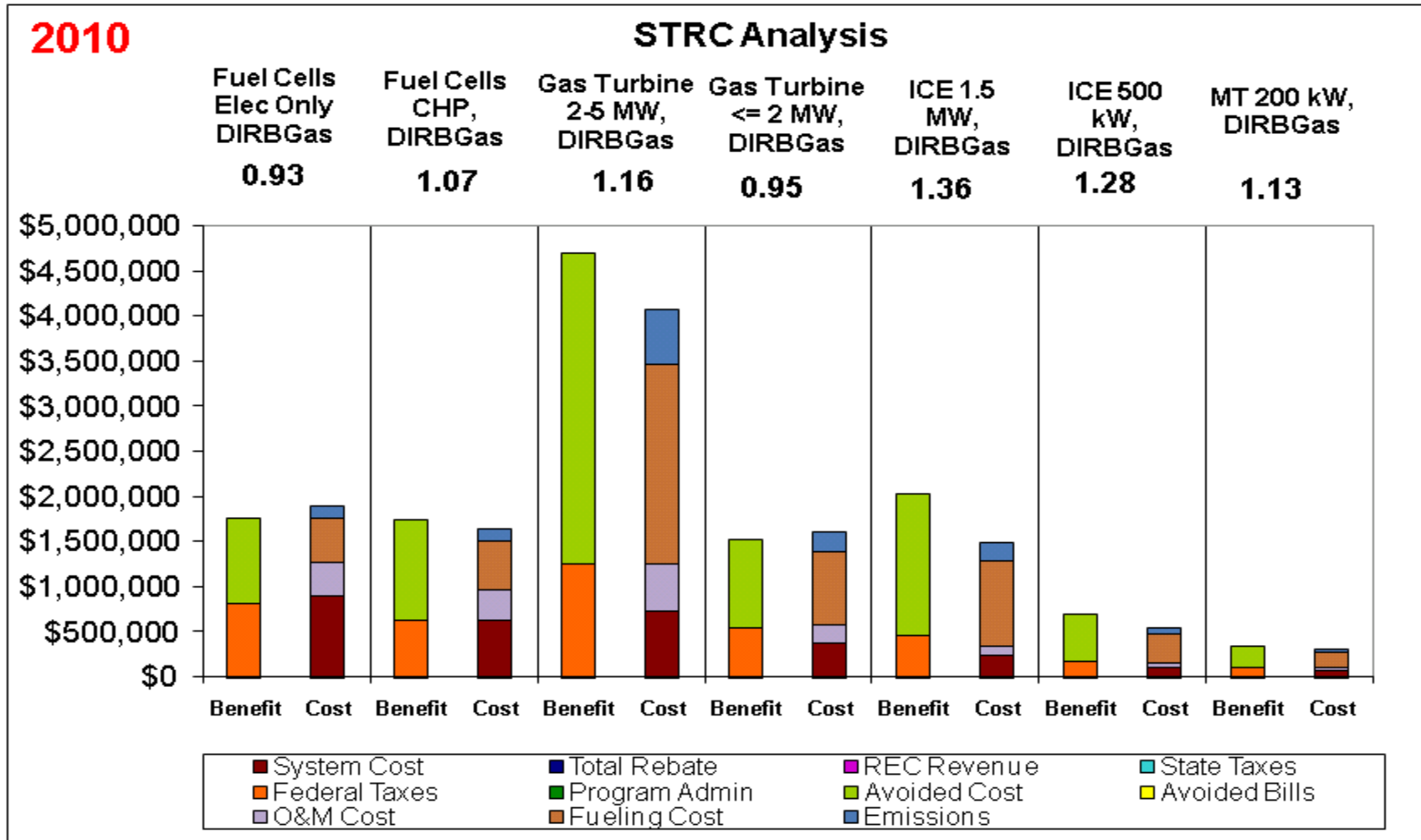

5.1.4 On-site Biogas-Fueled Results

Figure 5-8 shows the statewide STRC results for DG technologies fueled by on-site biogas in 2010 and 2016 without incentives. All the DG technologies using on-site biogas have a STRC in excess of 0.85 under the Base Scenario. The STRC for IC engines, microturbines, and large gas turbines (3,500 kW) are higher for the on-site biogas technologies than for technologies fueled by either natural gas or directed biogas. The STRC for fuel cells are lower for on-site biogas than for natural gas or directed biogas because fuel cells have a higher electrical efficiency and, therefore, lower fueling costs. Running the system on on-site biogas eliminates the fueling cost while adding higher system and O&M costs. The higher electrical efficiency of fuel cells implies a lower fueling cost and lower saved or eliminated fueling costs to compensate for the higher system and O&M costs.

Figure 5-8: Statewide Societal TRC Results for On-site Biogas Fuel (2010 and 2016), No Incentives

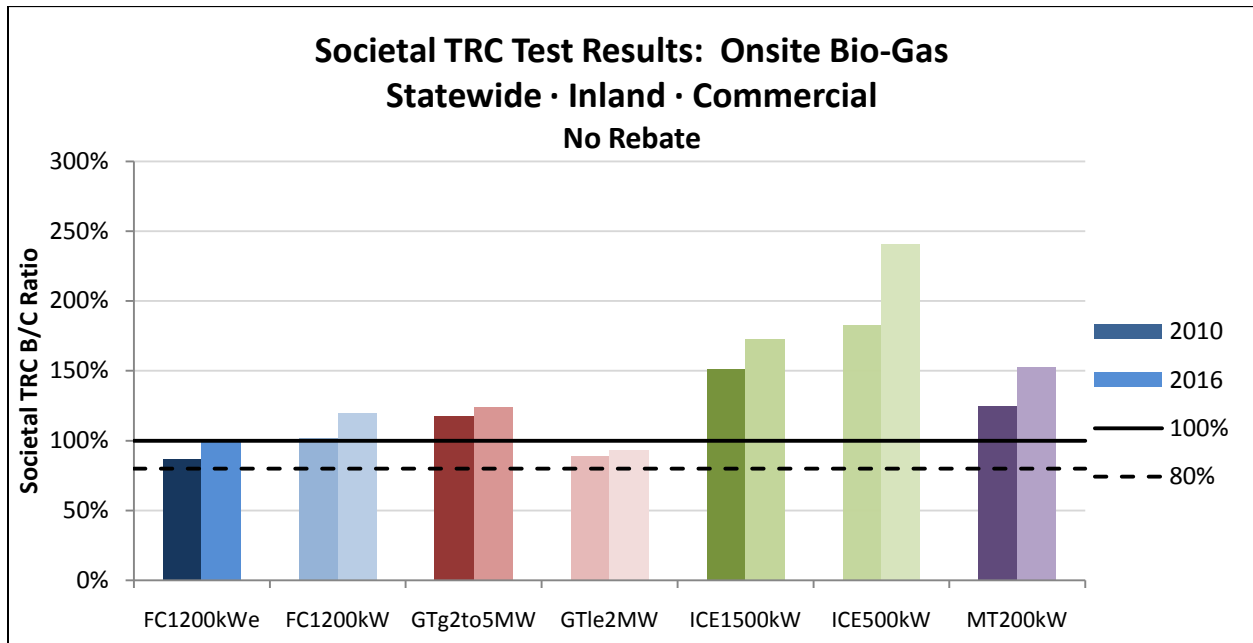
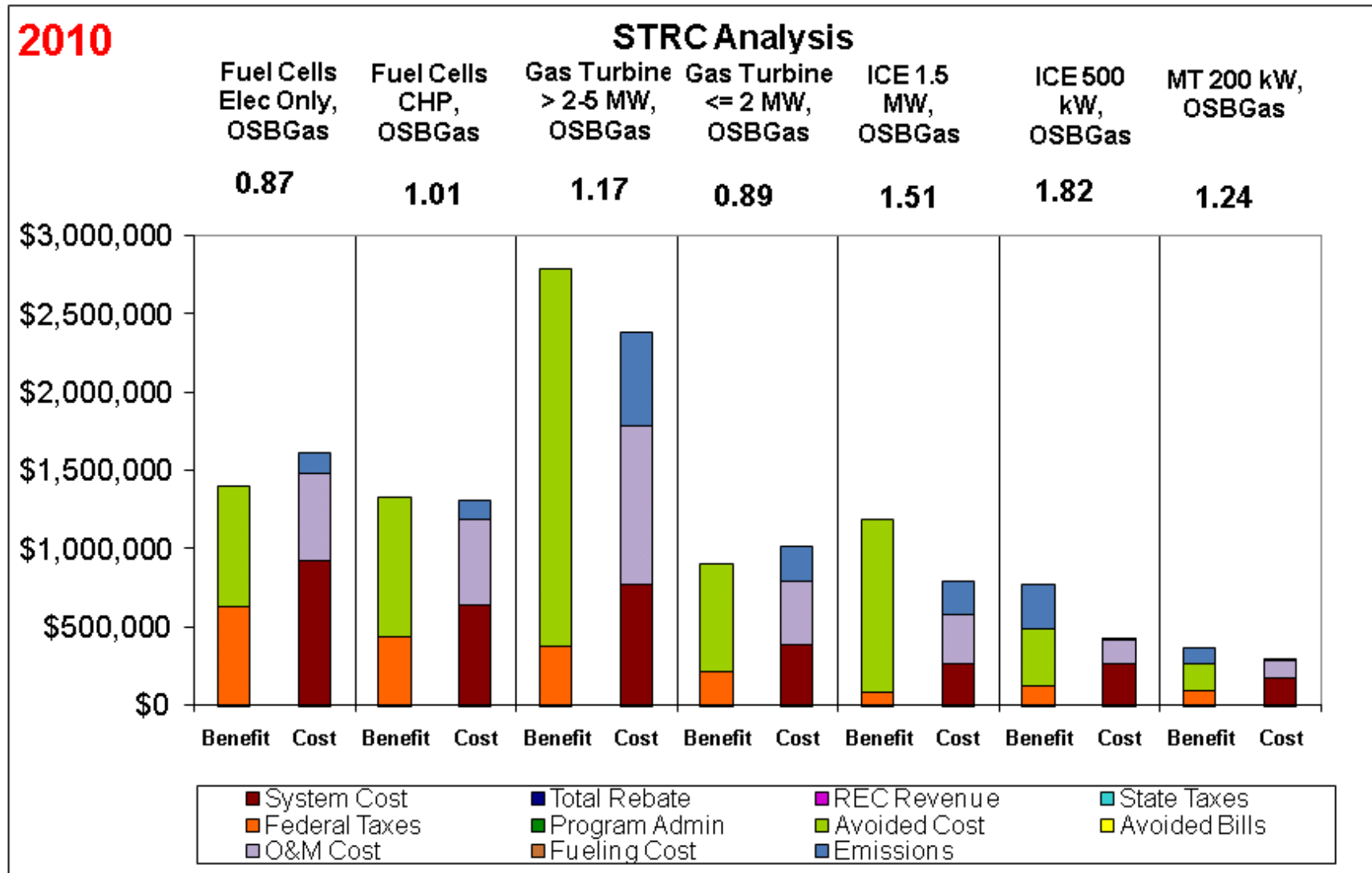

Table 5-5: STRC Test Levelized Costs and Benefits for On-site Biogas Technologies, PG&E Territory, No Rebate, 2010

2010	Fuel Cells Elec Only (1.2 MW)		Fuel Cells (1.2 MW)		Gas Turbine (>2-5 MW)		Gas Turbine (≤ 2 MW)		IC Engine (1.5 MW)		IC Engine (500 kW)		Microturbine (200 kW)	
	Benefit	Cost	Benefit	Cost	Benefit	Cost	Benefit	Cost	Benefit	Cost	Benefit	Cost	Benefit	Cost
System Cost	\$0	\$916,390	\$0	\$634,525	\$0	\$765,715	\$0	\$384,694	\$0	\$255,322	\$0	\$260,927	\$0	\$171,507
Federal Taxes	\$629,016	\$0	\$430,946	\$0	\$366,063	\$0	\$206,381	\$0	\$79,169	\$0	\$113,304	\$0	\$82,591	\$0
Avoided Cost	\$760,837	\$0	\$890,171	\$0	\$2,411,765	\$0	\$689,076	\$0	\$1,106,795	\$0	\$368,932	\$0	\$174,661	\$0
O&M Cost	\$0	\$562,949	\$0	\$543,490	\$0	\$1,008,952	\$0	\$403,925	\$0	\$318,642	\$0	\$160,079	\$0	\$121,213
Fueling Cost	\$0	\$0	\$0	\$0	\$0	\$0	\$0	\$0	\$0	\$0	\$0	\$0	\$0	\$0
Emissions	\$0	\$126,739	\$0	\$126,739	\$0	\$599,841	\$0	\$221,642	\$0	\$213,434	\$287,830	\$2,220	\$107,717	\$927
Total	\$1,389,853	\$1,606,078	\$1,321,117	\$1,304,754	\$2,777,828	\$2,374,507	\$895,456	\$1,010,261	\$1,185,964	\$787,398	\$770,066	\$423,226	\$364,970	\$293,646
Net Benefit	\$0	(\$216,225)	\$0	\$16,363	\$0	\$403,321	\$0	(\$114,805)	\$0	\$0	\$0	\$0	\$0	\$0
Ratio		0.87		1.01		1.17		0.89		1.51		1.82		1.24

The STRC does not include the rebate, REC revenue, state taxes, or avoided bills so these potential costs and benefits are not included in the table. With rebates zero, there is no program, so the program administrator costs are zero and not included in the table.

Figure 5-9: STRC Levelized Cost and Benefits for On-site Biogas Technologies, PG&E Territory, No Rebate, 2010



Technologies fueled by on-site biogas have higher system and O&M costs than technologies fueled by natural gas or directed biogas. The higher costs are associated with the installation of a biogas digester system (for example at dairies that would disposed of waste in some other manner) and for the maintenance of such systems.¹³

The electricity production from an on-site biogas system is also derated relative to a system fueled by natural gas or directed biogas. The useful energy content in on-site biogas is lower compared to natural gas or directed biogas.¹⁴ For those devices using on-site biogas, we could either increase the amount of gas for a given size device output or decrease the device output for a fixed amount of gas. We chose the latter approach and derated the electricity production. The derated electricity production leads to a lower avoided cost benefit for on-site biogas technologies relative to natural gas and directed biogas fueled systems.

The on-site biogas technologies evaluated in this model are evaluated under two different emissions assumptions. The smaller technologies, microturbines, and IC engines (500 kW) are modeled as dairies that were not previously capturing methane. The remaining technologies are modeled as waste water treatment plants, landfill operations, or other businesses that were required to capture their methane prior to the installation of the DG technology. When the smaller technologies are fueled by on-site biogas the cost effectiveness model adds the value of the captured emission to the benefits column. In Table 5-5 the levelized emissions benefit associated with methane capture for microturbines is \$107,717 while the levelized emissions benefit for IC engines is \$287,830. In Figure 5-9 the emissions benefits and costs are reflected by the blue-colored portion of the bar. The emission benefits significantly impact the cost-effectiveness of the smaller systems.

¹³ California environmental regulations do not require small on-site biogas applications such as dairies or food processing facilities to install biogas digesters in order to control methane emissions. Consequently, for these applications, the capital cost of a digester system was considered to be part of the measure cost.

¹⁴ In general, biogas has an energy content of approximately 500 Btu per cubic foot or nearly half that of natural or directed biogas.

5.1.5 Internal Combustion Engines

Under the Base Scenario, the 500 kW and the 1,500 kW IC engine are cost-effective for the STRC for all three fuels evaluated in the cost effectiveness model. The STRC results for IC engines are presented in Table 5-6 and Figure 5-10.

The results show that the system and O&M cost is higher for on-site biogas technologies than for natural gas or directed biogas systems. The higher cost is associated with the development of a biogas system that may not have existed previously (e.g., dairy) and for the maintenance of such systems. The lower avoided cost benefits of the on-site biogas system are associated with the degraded electrical production of these systems due to the derating assumption that we adopted for systems using on-site biogas. This treatment is consistent with the findings from the SGIP.

The federal tax benefits of the different systems and fueling choices are highly dependent on the system, operating, and fueling costs. The system, operating, and fueling costs are generally costs that contribute to a lower tax liability or a higher tax refund for the corporation or business. The directed biogas system has a higher tax benefit due to the higher fueling costs of this system configuration. The on-site biogas system has the lowest tax benefit due to the zero fueling costs associated with the on-site biogas configuration.

Table 5-6: STRC Test Levelized Costs and Benefits for IC Engines, PG&E, Inland, No Rebate, 2010

2010	IC Engine (1.5 MW) Natural Gas		IC Engine (1.5 MW) Directed Biogas		IC Engine (1.5 MW) On-site Biogas		IC Engine (500 kW) Natural Gas		IC Engine (500 kW) Directed Biogas		IC Engine (500 kW) On-site Biogas	
	Benefit	Cost	Benefit	Cost	Benefit	Cost	Benefit	Cost	Benefit	Cost	Benefit	Cost
System Cost		\$235,935		\$235,935		\$255,322		\$91,758		\$91,758		\$260,927
Federal Taxes	\$330,965		\$442,139		\$79,169		\$121,495		\$158,553		\$113,304	
Avoided Cost	\$1,581,135		\$1,581,135		\$1,106,795		\$527,045		\$527,045		\$368,932	
O&M Cost		\$101,360		\$101,360		\$318,642		\$56,070		\$56,070		\$160,079
Fueling Cost		\$932,379		\$932,379				\$310,793		\$310,793		
Emissions		\$216,021		\$216,021		\$213,434		\$78,596		\$78,596	\$287,830	\$2,220
Total	\$1,912,100	\$1,485,695	\$2,023,274	\$1,485,695	\$1,185,964	\$787,398	\$648,540	\$537,217	\$685,598	\$537,217	\$770,066	\$423,226
Net Benefit		\$426,405		\$537,579		\$398,565		\$111,324		\$148,382		\$346,839
Ratio		1.29		1.36		1.51		1.21		1.28		1.82

Figure 5-10: STRC Levelized Cost and Benefits for IC Engines in PG&E's Territory, Inland, No Rebate, 2010

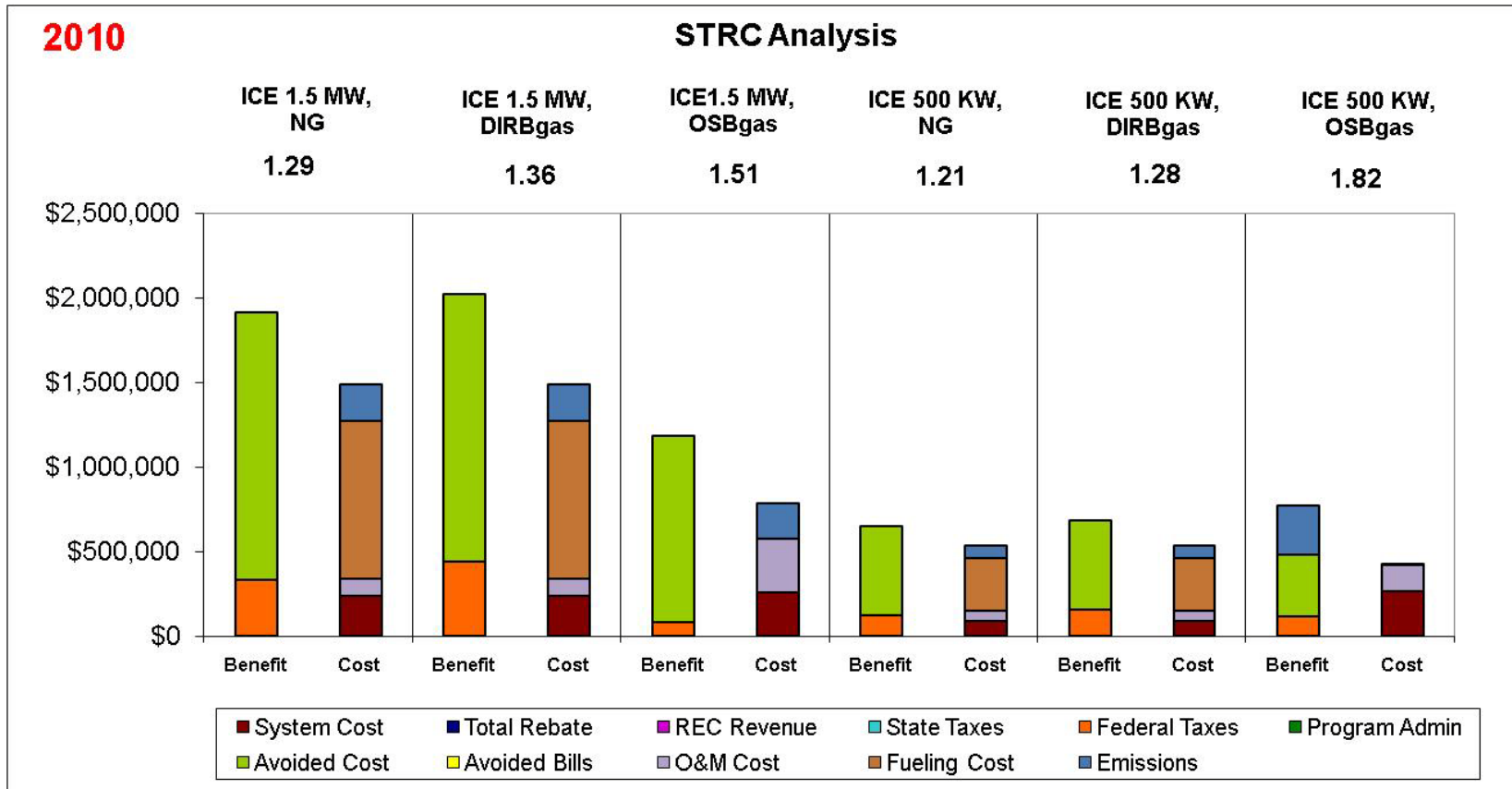

The emission costs and benefits of DG technologies are also dependent on fueling source and technology. The emission cost benefits associated with reducing the consumption of electricity otherwise provided from central power stations are included in the avoided cost benefits. The emission benefits associated with the capture of methane at dairy sites is clearly illustrated in the emission benefits in the 500 kW IC engine fueled by on-site biogas (blue benefits in Figure 5-10). Other technologies have both emission benefits associated with the reduction of electricity from central power station generation and the explicit increase in emissions associated with DG electricity production.

5.1.6 Fuel Cells

Under the Base Scenario the STRC value for electric-only fuel cells does not exceed 1.0 while the values for CHP fuel cells does exceed 1.0. The STRC results for fuel cells are presented in Table 5-6 and Figure 5-10. Electric-only fuel cells have a higher electrical efficiency, giving them a lower fueling cost relative to CHP fuel cells. The lower fueling costs, however, are offset by higher system costs for electric-only fuel cells. In addition, electric-only fuel cells do not benefit from the gas avoided cost benefits of the CHP fuel cells utilizing waste heat recovery.

Table 5-7: STRC Test Levelized Costs and Benefits for Fuel Cells, PG&E, Inland, No Rebate, 2010

2010	Fuel Cells Elec Only (1.2 MW) Natural Gas		Fuel Cells Elec Only (1.2 MW) Directed Biogas		Fuel Cells Elec Only (1.2 MW) On-site Biogas		Fuel Cells (1.2 MW) Natural Gas		Fuel Cells (1.2 MW) Directed Biogas		Fuel Cells (1.2 MW) On-site Biogas	
	Benefit	Cost	Benefit	Cost	Benefit	Cost	Benefit	Cost	Benefit	Cost	Benefit	Cost
System Cost		\$894,230		\$894,230		\$916,390		\$612,365		\$612,365		\$634,525
Federal Taxes	\$765,677		\$801,332		\$629,016		\$572,621		\$617,158		\$430,946	
Avoided Cost	\$951,046		\$951,046		\$760,837		\$1,112,713		\$1,112,713		\$890,171	
O&M Cost		\$364,451		\$364,451		\$562,949		\$344,992		\$344,992		\$543,490
Fueling Cost		\$495,739		\$495,739				\$538,846		\$538,846		
Emissions		\$127,361		\$127,361		\$126,739		\$127,361		\$127,361		\$126,739
Total	\$1,716,723	\$1,881,781	\$1,752,378	\$1,881,781	\$1,389,853	\$1,606,078	\$1,685,334	\$1,623,565	\$1,729,872	\$1,623,565	\$1,321,117	\$1,304,754
Net Benefit		\$(165,058)		\$(129,403)		\$(216,225)		\$61,770		\$106,307		\$16,363
Ratio		0.91		0.93		0.87		1.04		1.07		1.01

Figure 5-11: STRC Levelized Cost and Benefits for Fuel Cells in PG&E's Territory, Inland, No Rebate, 2010

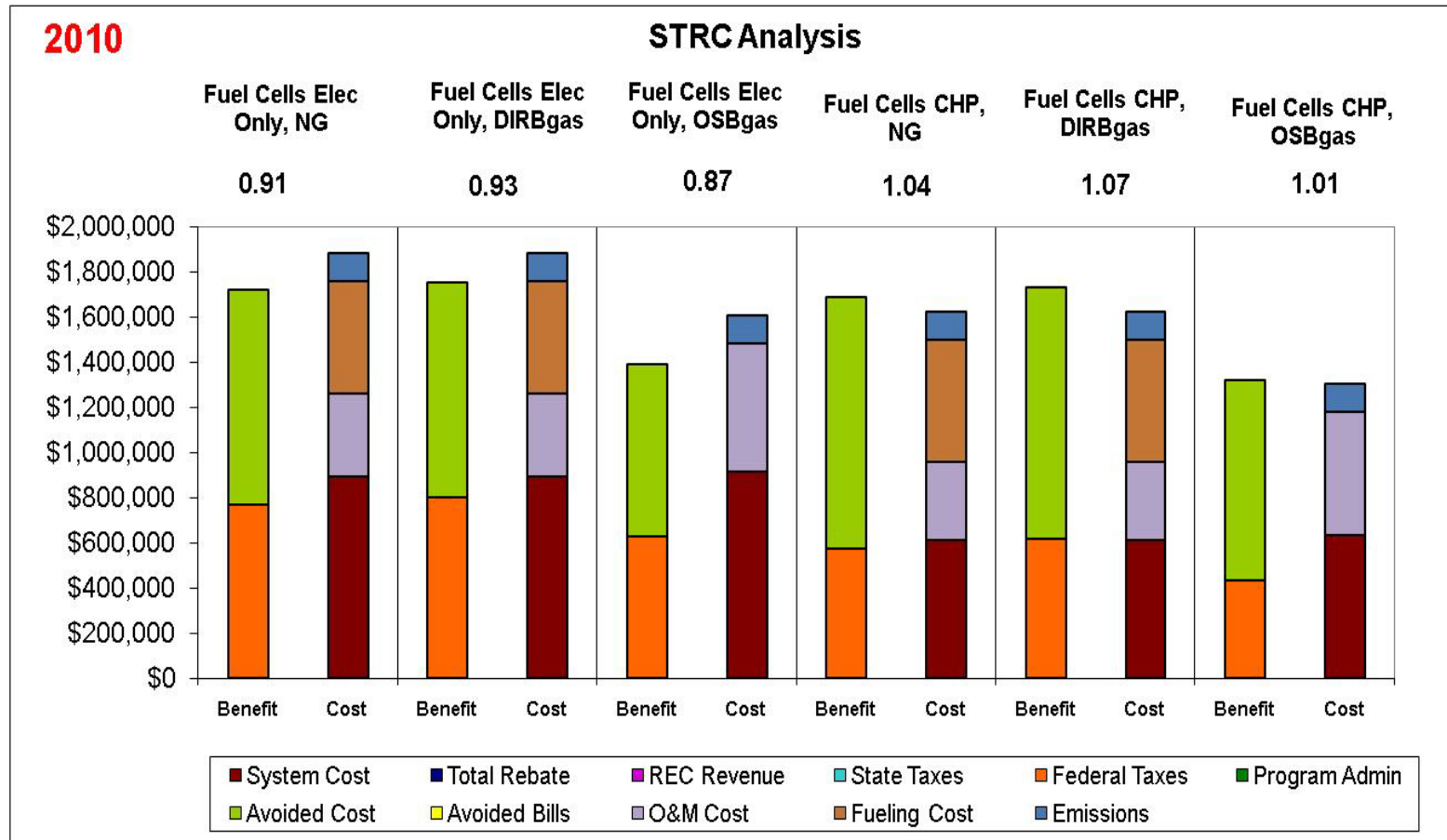

5.1.7 Microturbines

Under the Base Scenario the STRC value for microturbines exceeds 1.0 for all fuel choices (see Table 5-8 and Figure 5-12). The STRC is highest for microturbines fueled by on-site biogas. On-site biogas systems have a higher system and O&M cost but do not have a fueling cost. The avoided cost benefits for the on-site biogas system are lower than the natural gas or the directed biogas because the useful energy content in on-site biogas is lower compared to natural gas or directed biogas. Microturbines fueled by on-site biogas are modeled as being installed at sites that did not previously participate in methane capture. The installation of on-site biogas microturbines under this scenario leads to the capture of methane that did not occur previously and a substantial benefit to society. The emissions benefit of microturbines fueled with on-site biogas leads to a significant increase in their benefits, helping the system overcome higher costs and result in a higher STRC.

Table 5-8: STRC Test Levelized Costs and Benefits for Microturbines, PG&E, Inland, No Rebate, 2010

2010	Microturbine (200 kW) Natural Gas		Microturbine (200 kW) Directed Biogas		Microturbine (200 kW) On-site Biogas	
	Benefit	Cost	Benefit	Cost	Benefit	Cost
System Cost		\$55,311		\$55,311		\$171,507
Federal Taxes	\$63,599		\$87,522		\$82,591	
Avoided Cost	\$249,516		\$249,516		\$174,661	
O&M Cost		\$36,817		\$36,817		\$121,213
Fueling Cost		\$168,346		\$168,346		
Emissions		\$38,909		\$38,909	\$107,717	\$927
Total	\$313,115	\$299,383	\$337,038	\$299,383	\$364,970	\$293,646
Net Benefit		\$13,732		\$37,656		\$71,323
Ratio		1.05		1.13		1.24

Figure 5-12: STRC Test Levelized Costs and Benefits for Microturbines, PG&E, Inland, No Rebate, 2010

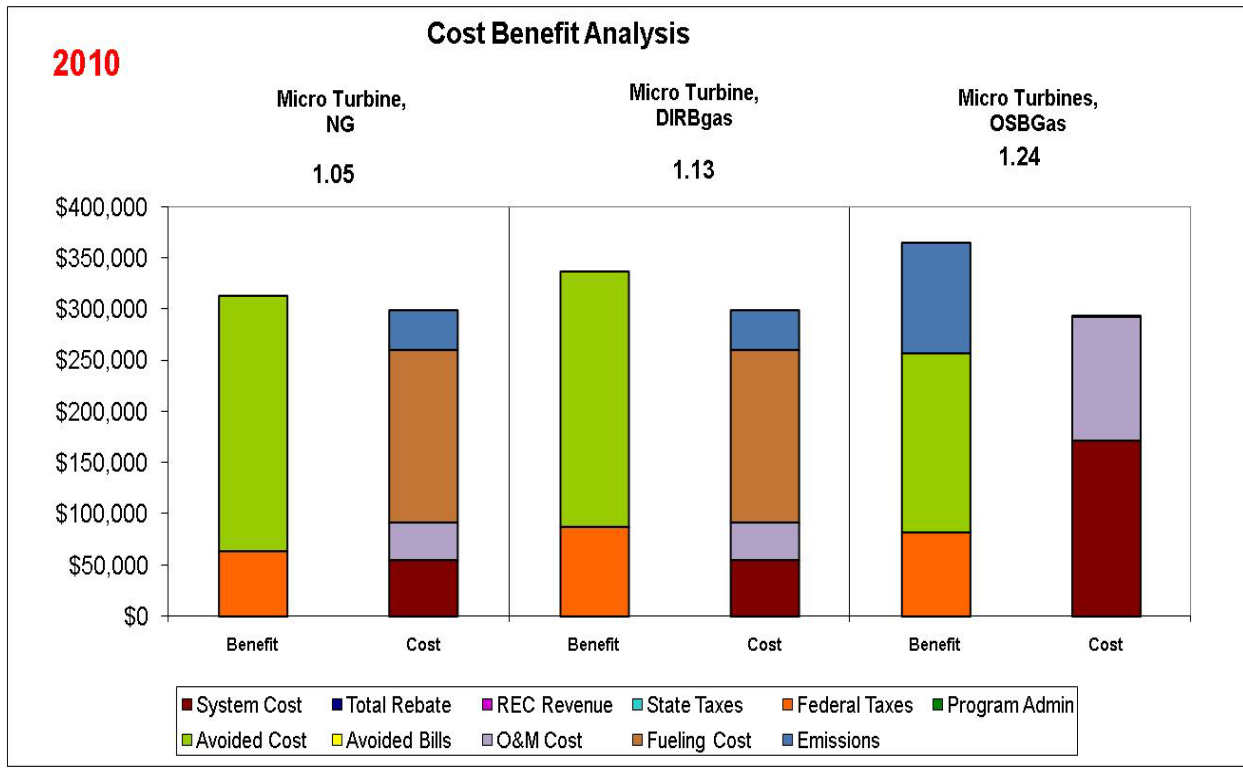

5.1.8 Gas Turbines

Under the Base Scenario, the STRC value for smaller gas turbines (under 2 MW) is greater than 0.85, but does not exceed 1.0. The STRC values for larger gas turbines (from 2-5 MW) exceed 1.0 for all fueling choices. The STRC results for gas turbines are presented in Table 5-9 and Figure 5-13. The additional avoided cost benefits of the larger turbines are more than sufficient to overcome the higher cost, leading to STRC test that exceeds 1.0.

Comparing the results for the microturbines with those of the smaller and larger gas turbines, microturbines and larger gas turbines have a lower cost relative to their avoided cost benefits than smaller gas turbines. The ratio of the avoided cost benefit for natural gas fueled microturbines to their system cost is 4.5; the same ratio is 4.8 for large gas turbines and 2.7 for small gas turbines. The higher the ratio, the larger the avoided cost benefits relative to the system cost. Smaller gas turbines have a relatively high system cost, including the pollution control costs relative to microturbines and larger gas turbines (See Appendix A for more information on technology costs). The lower system cost and larger system avoided cost benefits help microturbines and larger gas turbines to be cost-effective from society's point of view while smaller gas turbines are less cost-effective.

Table 5-9: STRC Test Levelized Costs and Benefits for Gas Turbines, PG&E, Inland, No Rebate, 2010

2010	Gas Turbine (>2-5 MW) Natural Gas		Gas Turbine (>2-5 MW) Directed Biogas		Gas Turbine (>2-5 MW) On-site Biogas		Gas Turbine (≤ 2 MW) Natural Gas		Gas Turbine (≤ 2 MW) Directed Biogas		Gas Turbine (≤ 2 MW) On-site Biogas	
	Benefit	Cost	Benefit	Cost	Benefit	Cost	Benefit	Cost	Benefit	Cost	Benefit	Cost
System Cost		\$711,781		\$711,781		\$765,715		\$365,250		\$365,250		\$384,694
Federal Taxes	\$973,264		\$1,240,199		\$366,063		\$413,879		\$528,453		\$206,381	
Avoided Cost	\$3,445,378		\$3,445,378		\$2,411,765		\$984,394		\$984,394		\$689,076	
O&M Cost		\$539,152		\$539,152		\$1,008,952		\$194,990		\$194,990		\$403,925
Fueling Cost		\$2,195,802		\$2,195,802				\$813,260		\$813,260		
Emissions		\$609,009		\$609,009		\$599,841		\$224,158		\$224,306		\$221,642
Total	\$4,418,642	\$4,055,744	\$4,685,577	\$4,055,744	\$2,777,828	\$2,374,507	\$1,398,273	\$1,597,658	\$1,512,847	\$1,597,807	\$895,456	\$1,010,261
Net Benefit		\$362,898		\$629,833		\$403,321		\$(199,385)		\$(84,960)		\$(114,805)
Ratio		1.09		1.16		1.17		0.88		0.95		0.89

Figure 5-13: STRC Levelized Cost and Benefits for Gas Turbines, PG&E Territory, No Rebate, 2010

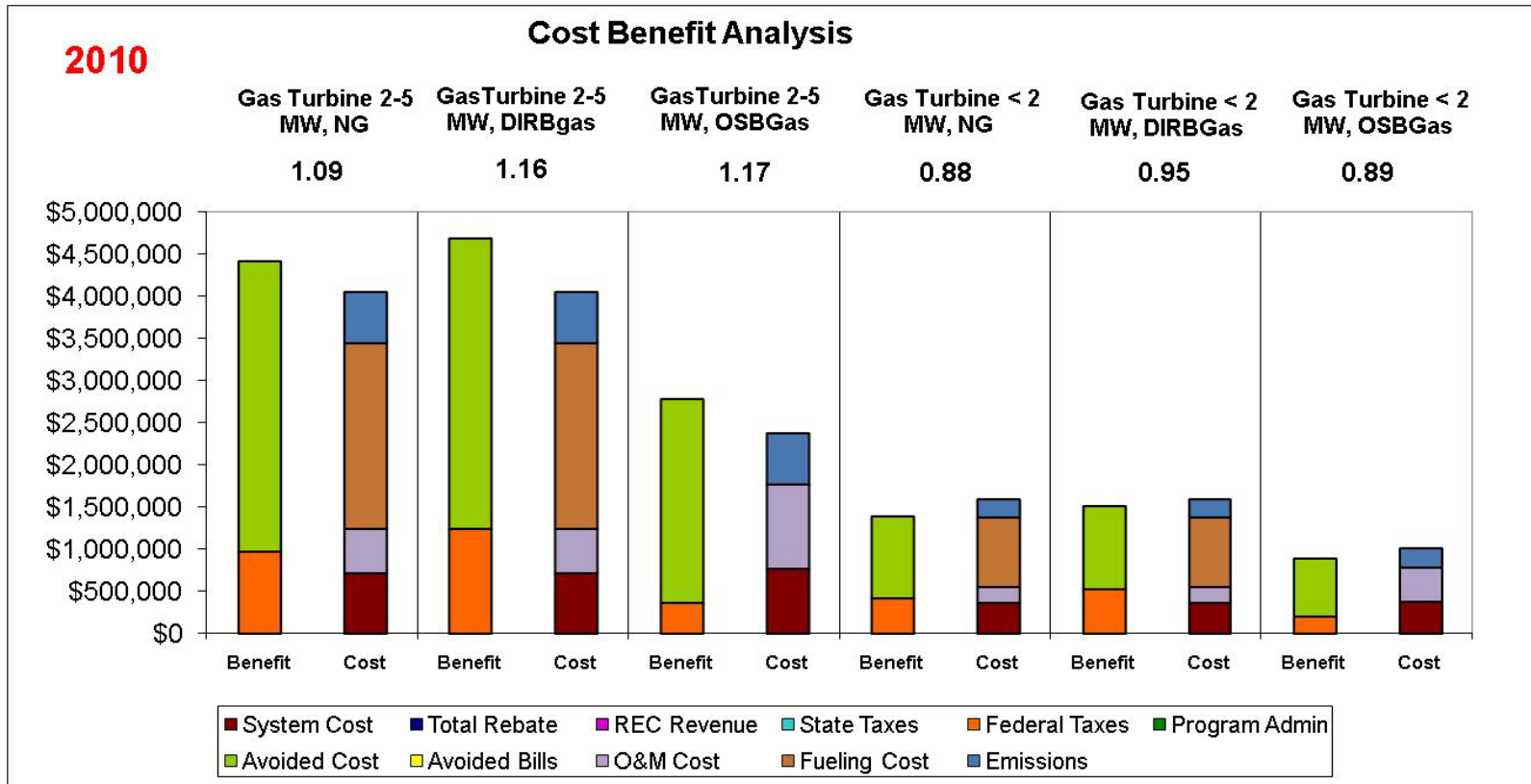

5.2 Participant Cost Test Results

5.2.1 Statewide Results

As indicated at the start of the results section, the Participant Cost test (PCT) examines the cost-effectiveness of the DG technology to the participant. It can be used to help design an approach on incentives to be paid to the participant.

Similar to the STRC, the SGIPce model generates PCT test results (i.e., the benefit-to-cost ratios) by DG technology, electric IOU territory, sector (e.g., commercial, residential or government/non-profit) and geographical region (“coastal” and “inland”). Table 5-10 is a summary of the combined IOU-specific and statewide PCT results for 2010 and 2016 by DG technologies deployed in the commercial sector. We have focused on commercial sector results as commercial sector applications have made up the majority of SGIP applications in the past. Statewide PCT results for the residential and government/non-profit sectors are presented in Appendix C.

Table 5-10: Statewide Summary of Commercial Sector PCT Results for 2010 and 2016, No Incentives

Technology	System Size (kW)	PG&E		SCE		SDG&E		Statewide Equalized		Statewide Elec. Sales Wgtd.	
		PCT - 2010	MIRR	PCT - 2010	MIRR	PCT - 2010	MIRR	PCT - 2010	MIRR	PCT - 2010	MIRR
Wind Turbine											
1 MW nonresidential/government	1,000	1.63	14.5%	1.57	14.2%	1.36	13.0%	1.52	13.9%	1.58	14.2%
Fuel Cell - Electric Only											
Natural gas	1,200	0.95	9.4%	0.93	9.1%	0.82	7.3%	0.90	8.6%	0.93	9.1%
On-site biogas	1,200	1.00	10.3%	0.99	10.1%	0.89	8.7%	0.96	9.7%	0.98	10.0%
Directed biogas	1,200	0.92	8.8%	0.91	8.5%	0.82	6.6%	0.88	8.0%	0.91	8.5%
Fuel Cell - CHP (i.e., w/waste heat recovery)											
Natural gas powered	1,200	1.02	10.6%	1.00	10.2%	0.86	7.6%	0.96	9.5%	0.99	10.1%
On-site biogas	1,200	1.12	11.7%	1.10	11.5%	0.97	9.8%	1.06	11.0%	1.09	11.4%
Directed biogas	1,200	0.98	9.7%	0.95	9.1%	0.84	6.3%	0.93	8.4%	0.95	9.1%
Gas Turbine - CHP											
Natural gas powered (1000 kW)	1,000	0.89	6.3%	0.88	5.7%	0.75	1.2%	0.84	4.4%	0.87	5.5%
On-site biogas (1000 kW)	1,000	1.06	10.9%	1.05	10.7%	0.91	8.3%	1.01	9.9%	1.04	10.5%
Directed biogas (1000 kW)	1,000	0.81	0.0%	0.80	-0.5%	0.71	-5.4%	0.77	-2.0%	0.80	-0.8%
Natural gas powered (3500 kW)	3,500	1.07	12.2%	1.05	11.6%	0.88	4.5%	1.00	9.4%	1.04	11.2%
On-site biogas (3500 kW)	3,500	1.40	14.8%	1.38	14.6%	1.17	12.4%	1.32	14.0%	1.37	14.5%
Directed biogas (3500 kW)	3,500	0.95	6.8%	0.94	5.8%	0.81	-3.9%	0.90	2.9%	0.93	5.3%
Microturbine - CHP											
Natural gas powered	200	0.98	9.2%	0.98	9.3%	0.84	3.1%	0.93	7.2%	0.97	8.7%
On-site biogas	200	0.82	7.0%	0.83	7.0%	0.75	5.7%	0.80	6.6%	0.82	6.9%
Directed biogas	200	0.87	0.9%	0.87	1.0%	0.77	-5.8%	0.84	-1.3%	0.86	0.3%
IC Engine - CHP											
Natural gas powered (500 kW)	500	1.18	14.5%	1.18	14.6%	0.99	9.6%	1.11	12.9%	1.16	14.1%
On-site biogas (500 kW)	500	1.06	10.7%	1.07	10.8%	0.94	9.2%	1.03	10.2%	1.05	10.6%
Directed biogas (500 kW)	500	1.02	11.0%	1.02	11.1%	0.89	1.6%	0.98	7.9%	1.01	10.1%
Natural gas powered (1500 kW)	1,500	1.24	15.9%	1.24	15.9%	1.03	11.3%	1.17	14.4%	1.22	15.4%
On-site biogas (1500 kW)	1,500	1.81	17.4%	1.82	17.5%	1.54	15.8%	1.72	16.9%	1.79	17.3%
Directed biogas (1500 kW)	1,500	1.05	12.6%	1.06	12.7%	0.92	3.0%	1.01	9.4%	1.04	11.7%
Organic Rankine Cycle											
	500	1.22	11.8%	1.21	11.8%	1.01	10.1%	1.15	11.2%	1.19	11.6%
Storage											
Med storage	25	0.46	-14.1%	0.45	-13.4%	0.42	-13.3%	0.44	-13.6%	0.45	-13.7%
Larger storage	1,000	0.51	-14.9%	0.50	-13.9%	0.47	-13.4%	0.49	-14.1%	0.50	-14.3%

In addition to PCT results, Table 5-10 also contains values for a modified internal rate of return (MIRR). The MIRR represents a financial evaluation of an investment's attractiveness and can be used to rank alternative investments. A higher MIRR value reflects a more attractive investment. Each IOU-specific PCT benefit-to-cost ratio has an associated MIRR value. Table 5-10 also provides statewide PCT results and statewide MIRR values. The statewide results are obtained by first averaging the IOU results arithmetically and then weighted by the percentage of electricity sales. It is important to recognize that the statewide MIRR results reflect weighted averages of the IOU-specific MIRR results.

Review of the PCT results in Table 5-10 indicates the following:

- The PCT results are always higher for PG&E and SCE than for SDG&E. SDG&E's rates are lower than PG&E and SCE for the commercial sector so the avoided bill benefit is lower for SDG&E.
- IC engines (1,500 kW) fueled by on-site biogas have the highest PCT test value of any commercial system analyzed under the Base Scenario without incentives. The PCT is 1.81 for PG&E, 1.82 for SCE, and 1.54 for SDG&E. Note that IC engines (1,500 kW) fueled by on-site biogas also have a relatively high STRC. The STRC for IC engines (1,500 kW) is 1.5 in 2010 and 1.74 in 2016 for the statewide electricity weighted results.
- Wind and ORC pass the PCT for all three utilities. These two technologies also pass the STRC for all three utilities.
- IC engines (500 kW) have a PCT greater than 1.0 for natural gas-, on-site biogas-, and directed biogas-fueled systems without an incentive for PG&E and SCE. Natural gas and on-site biogas systems have PCT values of nearly 1.0 for SDG&E.
- Both electric-only fuel cells and fuel cells using waste heat recovery pass or nearly pass the PCT when fueled by on-site biogas. The PCT values for systems fueled by natural gas and directed biogas are slightly lower, though still over 0.90 for PG&E and SCE.
- Gas turbines in the 2-5 MW range (modeled as 3.5 MW) pass the PCT when fueled by on-site biogas for all three utilities. Gas turbines (3.5 MW) also pass the PCT when fueled by natural gas in PG&E and SCE territory.
- Gas turbines in the less than 2 MW range (modeled as 1 MW) pass the PCT when fueled by on-site biogas for PG&E and SCE.
- Microturbines regardless of fuel type fail to pass the PCT, but are very close to passing the test when fueled by natural gas, rather than on-site biogas or directed biogas.
- Storage fails to pass the PCT by a wide margin for all utilities.

The following observations can be made about MIRR results contained in the table:

- For DG technologies that pass the PCT, the IOU-specific MIRR values fall between 10.3% and 17.4%.
- Generally, the MIRR values for DG technologies passing the PCT fall either in 10-11.9% range or 14+%. Very few of the systems with PCT greater than 1.0 have MIRR values from 12-13.9%.

MIRR can be used to investigate the effect of changing the amount of incentive provided to the participant on the financial attractiveness of the investment. The MIRR values in Table 5-10 reflect costs and benefits for each DG technology without incentives. Different MIRR values can be obtained by “freezing” the costs and changing only the incentives. This approach was used to determine the incentive levels needed for each DG technology to reach pre-defined levels of MIRR. In general, incentives were calculated starting at MIRR levels of 10%, going up incrementally by 1% to an upper MIRR level of 15%. Results were tabulated and graphed for each DG technology, by electric IOU territory, fuel type, and “geographical” location. In addition, each table and graph indicates, where possible, MIRR values associated with no incentives and actual incentive levels provided to the technology under the SGIP at 2010.

The following sections provide the results of the PCT/MIRR incentive calculations for each grouping of DG technologies. As with the STRC results, we have focused only on results specific to the commercial sector. In addition, we provide results only for one electric IOU service territory (PG&E) in order to reduce the number of tables and graphs. Results from the SCE and SDG&E service territories will be different due to differences in electricity and gas rates. However, the results for PG&E provide good representation of the types of finding and trends that would be applicable in the other electric IOU service territories. PG&E PCT values will be very close to those for SCE and higher than the PCT values for SDG&E.

5.2.2 Fuel Cell Results

Electric Only Fuel Cells

Figure 5-14 shows the impact of changing incentive levels for electric-only fuel cells sized nominally at 1,200 kW and powered by natural gas.

Figure 5-14: PCT Results for Electric-Only Fuel Cell, Natural Gas (PG&E)

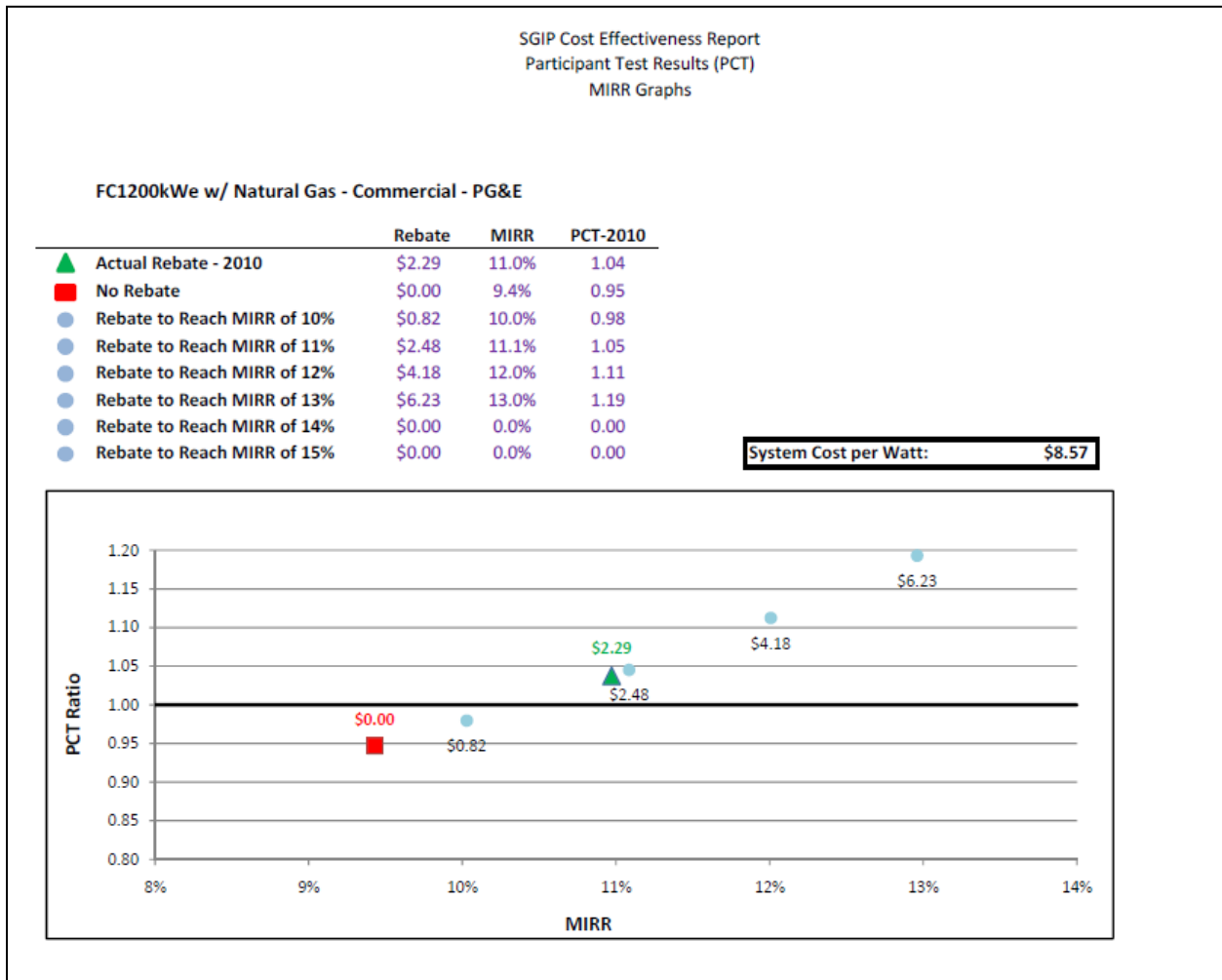

Figure 5-14 shows that fuel cells charged by natural gas have a PCT ratio of 0.95 in 2010 without an incentive (with an associated MIRR of 9.4%) in PG&E’s territory under the Base Scenario.¹⁵ Within the SGIP, a natural gas-powered fuel cell sized at 1,200 kW would be eligible to receive an incentive of \$2.29/Watt. At that incentive level, the PCT ratio would

¹⁵ The value of the PCT and MIRR will vary by service territory. The PCT and MIRR vary more by IOU than the STRC because the utility rate structures vary more than the IOU-specific avoided costs. The PCT and MIRR values for 2010 are available in Table 5-10 and the PCT and MIRR iteration figures are available in Appendix C.

increase to 1.04 and the corresponding MIRR would be 11.0%. To obtain an MIRR of 10%, the incentive must fall to \$0.82/Watt. For a 12% MIRR, the incentive must be \$4.18/Watt and \$6.23/Watt for an MIRR of 13%. MIRR values were not calculated above 13% for fuel cells in PG&E's territory because it would have required an incentive in excess of the system cost of \$8.51/Watt. SGIP rules do not allow incentives to exceed the cost of the measure.

Figure 5-15 shows the effect of changing the incentive on the MIRR and PCT for fuel cells nominally sized at 1,200 kW and powered by directed biogas in PG&E's territory under the Base Scenario. Directed biogas has many similar operational characteristics to natural gas system, and the system and O&M costs for fuel cells powered by natural gas and directed biogas are modeled to be the same. Fuel cells powered by directed biogas, however, have higher fueling costs than their natural gas-powered counterparts (i.e., reflecting the additional costs associated with clean-up and processing of biogas to make it into nominated "directed biogas"). Fuel cells powered by directed biogas, however, receive a REC payment in 2013 and beyond, increasing their benefits relative to the natural gas-fueled system.¹⁶

¹⁶ REC benefits are assumed to be zero prior to 2013. A system installed in 2010 receives no REC benefits in 2010-2012, but is modeled to receive this benefit from 2013-2030.

Figure 5-15: PCT Results for Electric-Only Fuel Cell, Directed Biogas (PG&E)

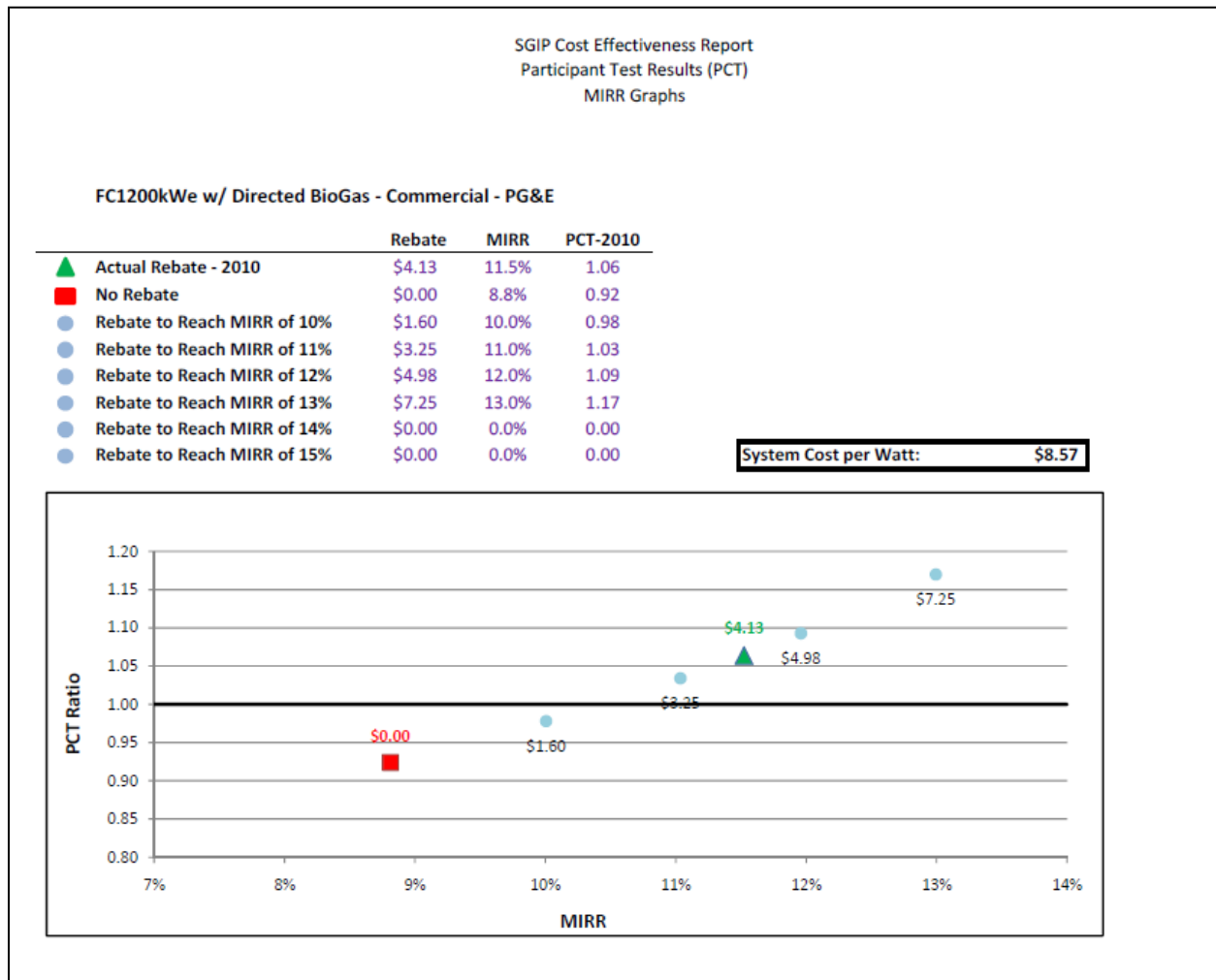

Based on a nominal size of 1,200 kW, fuel cells powered by directed biogas have a PCT ratio of 0.92 in 2010 without an incentive (with an associated MIRR of 8.8%) in PG&E’s territory under the Base Scenario. Within the SGIP, a fuel cell charged with directed biogas and sized at 1,200 kW would be eligible to receive an incentive of \$4.13/Watt. At that incentive level, the PCT ratio would increase to 1.06 (i.e., be considered cost-effective to the participant by the SPM) and the corresponding MIRR would be 11.5%. Figure 5-15 illustrates the incentives needed to reach alternative MIRR levels. To reach an MIRR of 12% requires an incentive of \$4.98, while \$7.25/Watt is needed to reach a 13% MIRR. Incentives were not calculated above an MIRR of 13% as the amount of incentive required would exceed the cost of the measure.

Figure 5-16 shows the effect of changing the incentive level on the MIRR and PCT for fuel cells nominally sized at 1,200 kW and powered by on-site biogas in PG&E’s territory under the Base Scenario. DG technologies fueled with on-site biogas have higher capital investment and non-

fuel-related O&M expenses than the same technologies fueled with natural gas or directed biogas (due to additional equipment required to capture and clean the biogas). DG technologies fueled by on-site biogas also have lower electric bill saving benefits because they are modeled to produce less electricity than similar systems fueled by natural gas or directed biogas. DG technologies fueled by on-site biogas, however, have no on-going fuel purchase expenses and receive revenues from sales of RECs.

Figure 5-16: PCT Results for Electric-Only Fuel Cell: On-site Biogas (PG&E)

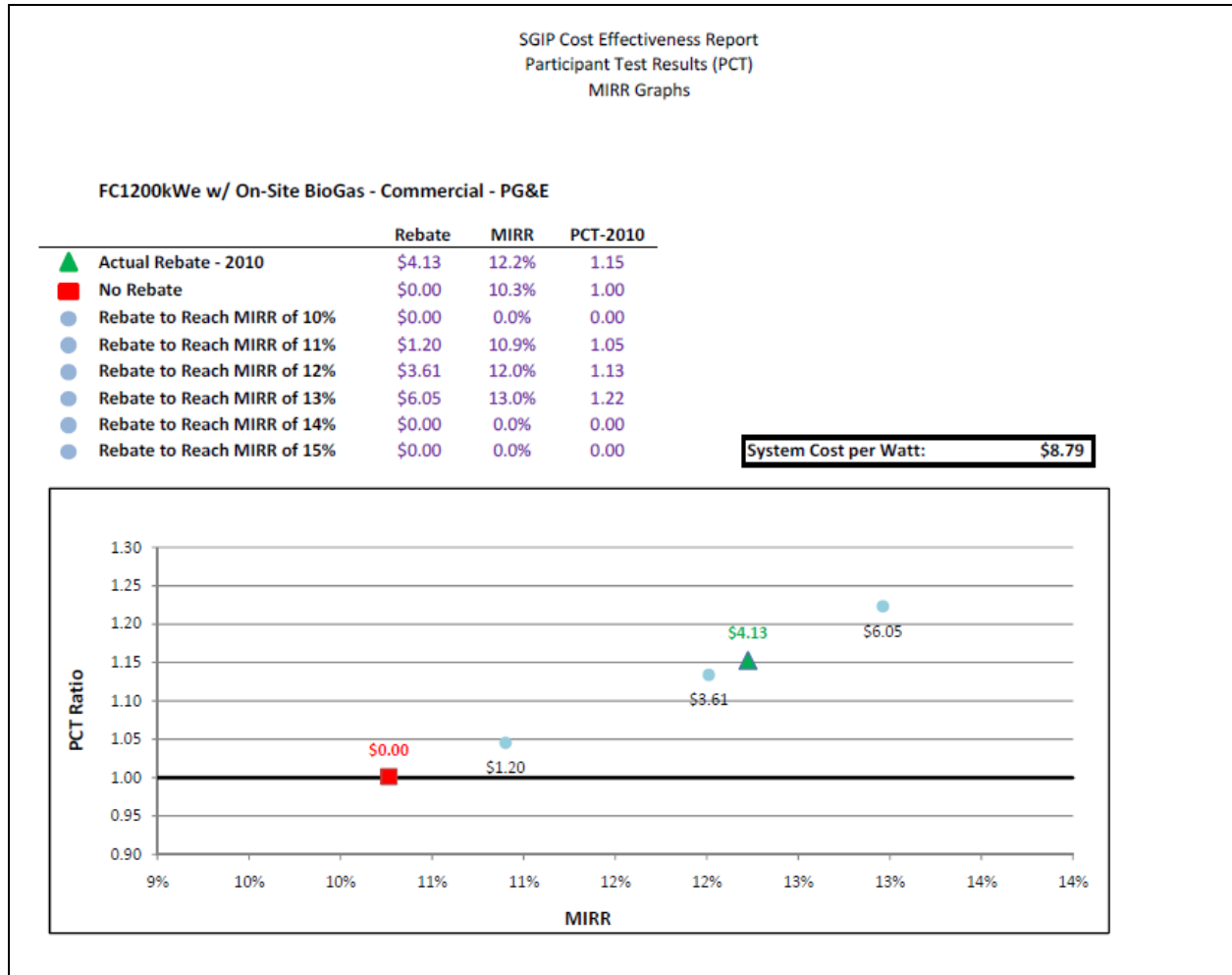

Based on a nominal size of 1,200 kW, fuel cells powered by on-site biogas have a PCT ratio of 1.0 in 2010 without an incentive (with an associated MIRR of 10.3%) in PG&E’s service territory. Fuel cells in this size range fueled by on-site biogas just pass the PCT without an incentive in PG&E’s territory. As shown in Table 5-10, on-site biogas fuel cells without an incentive have a PCT of 0.99 in SCE’s territory and 0.89 in SDG&E’s territory. Within the SGIP, a fuel cell charged with on-site biogas and sized at 1,200 kW would be eligible to receive an incentive of \$4.13/Watt. At that incentive level, the PCT ratio would increase to 1.15 and the

corresponding MIRR would be 12.2% within PG&E's service territory. To reach an MIRR value of 13% requires an incentive of \$6.05/Watt. Incentives were not calculated to reach an MIRR of 14% or above as the amount of incentive required would exceed the cost of the measure.

It is interesting to note that electric-only fuel cells powered by either on-site biogas, natural gas, or directed biogas show MIRR values in the 11-12% range at the incentive levels provided to these technologies under the 2010 SGIP rules (\$4.13/Watt for directed and on-site biogas and \$2.29 for natural gas). Under the current incentive formulation, these systems provide the participant with an expected distribution of costs and benefits such that the measures are cost-effective from the participant's point of view.

Fuel Cells with Waste Heat Recovery

Fuel cells that use waste heat recovery have some additional capital investment due to the additional waste heat recovery equipment and are modeled to have a lower electrical efficiency than electric-only fuel cells. CHP fuel cells, however, receive benefits from displacing natural gas used to fuel on-site boilers. Consequently, PCT results for fuel cells using waste heat recovery are slightly higher than PCT results for electric-only fuel cells.

Figure 5-17 shows the impact of changing incentive levels for fuel cells using waste heat recovery, sized nominally at 1,200 kW and powered by natural gas in PG&E's territory under the Base Scenario.

Figure 5-17: PCT Results for Fuel Cell with Heat Recovery: Natural Gas (PG&E)

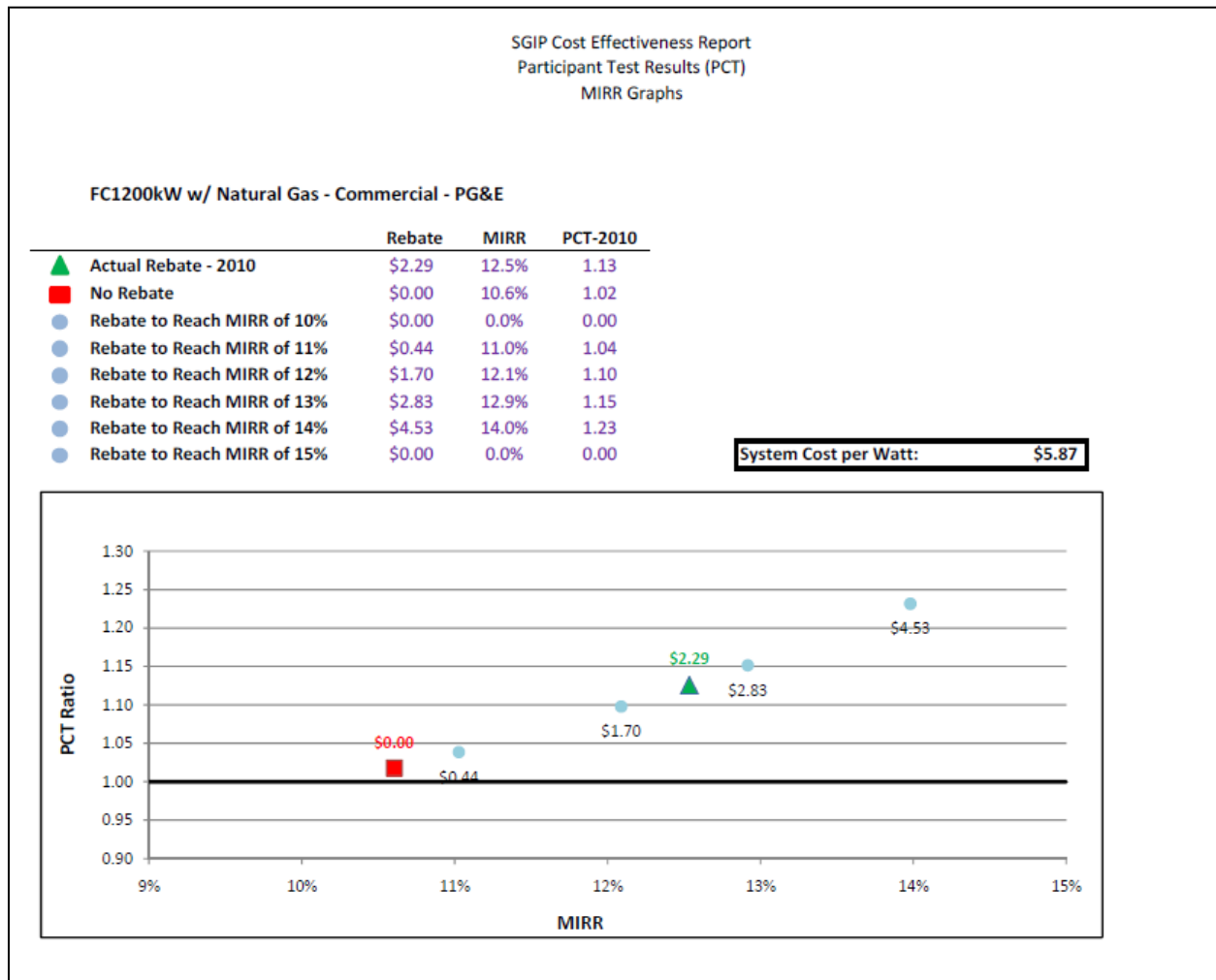

Fuel cells using waste heat recovery and charged by natural gas show a PCT ratio of 1.02 in 2010 without an incentive (with an associated MIRR of 10.6%). Within the SGIP, this same natural gas-powered fuel cell sized at 1,200 kW would be eligible to receive an incentive of \$2.29/Watt. At that incentive level, the PCT ratio would increase to 1.13 (i.e., be considered cost-effective from the participant’s perspective by the SPM) and the corresponding MIRR would be 12.5%. Increases in incentives levels to \$2.83/Watt and to \$4.53/Watt would be required to increase the MIRR to 13% and 14%, respectively. Incentives were not calculated above an MIRR of 14% as the amount of incentive required to reach an MIRR of 15% would exceed the cost of the measure.

Figure 5-18 shows the effect of changing the incentive level on the MIRR for fuel cells nominally sized at 1,200 kW, using waste heat recovery and powered by directed biogas in PG&E’s territory under the Base Scenario.

Figure 5-18: PCT Results for Fuel Cell with Heat Recovery, Directed Biogas (PG&E)

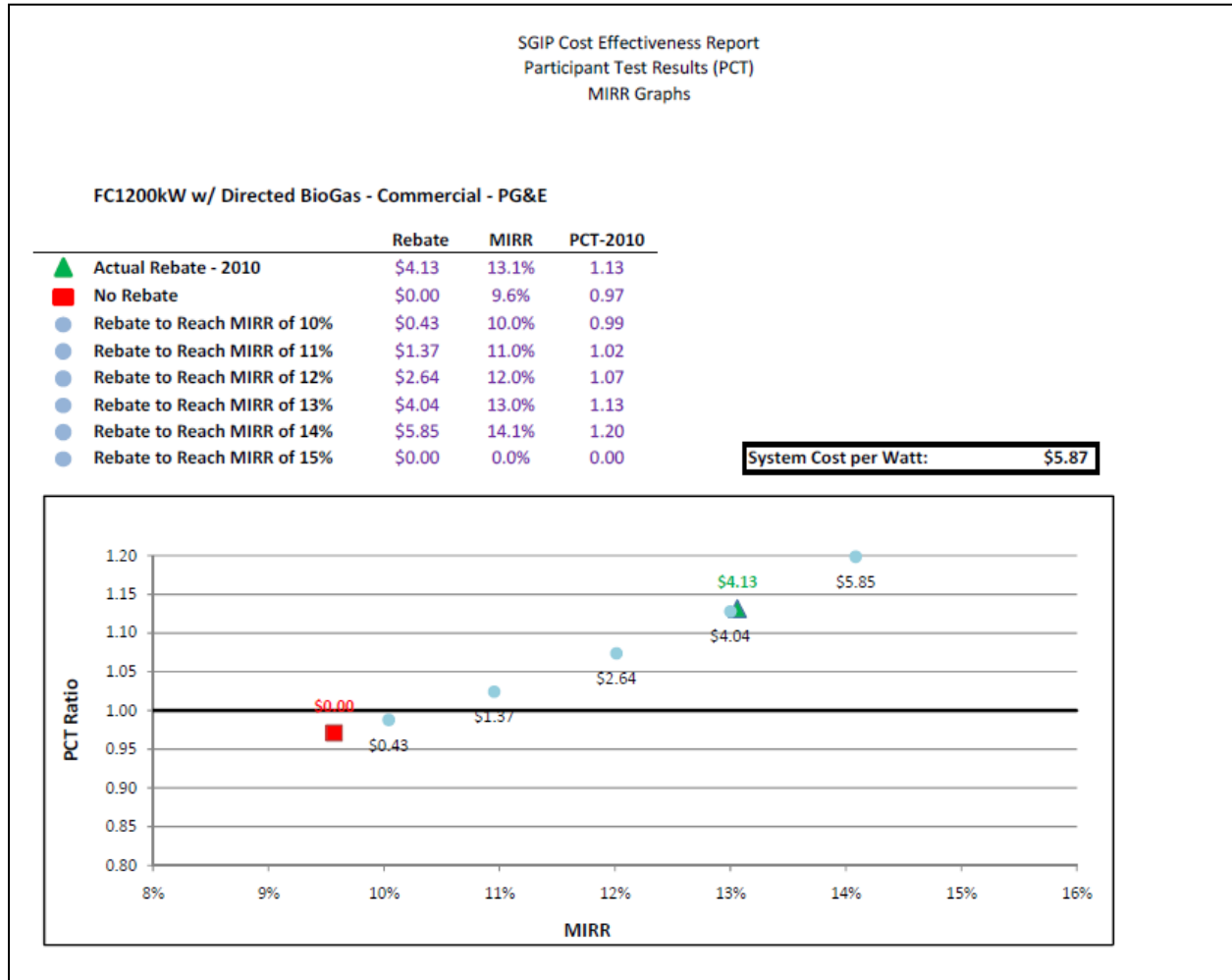

Based on a nominal size of 1,200 kW, fuel cells powered by directed biogas and using waste heat recovery have a PCT ratio of 0.97 in 2010 without an incentive (with an associated MIRR of 9.6%). Within the SGIP, a fuel cell charged with directed biogas and sized at 1,200 kW would be eligible to receive an incentive of \$4.13/Watt. At that incentive level, the PCT ratio would increase to 1.13 (i.e., be considered cost-effective from the participant’s perspective by the SPM) and the corresponding MIRR would be 13.1%. To increase the MIRR from 13.1% to 14%, requires the incentive increases from \$4.13/Watt to \$5.85/Watt. Incentives were not calculated above an MIRR of 14% as the amount of incentive required would exceed the cost of the measure.

Figure 5-19 illustrates the effect of changing the incentive level on the MIRR for fuel cells nominally sized at 1,200 kW, using waste heat recovery and powered by on-site biogas in PG&E’s territory under the Base Scenario.

Figure 5-19: PCT Results for Fuel Cell with Heat Recovery, On-site Biogas (PG&E)

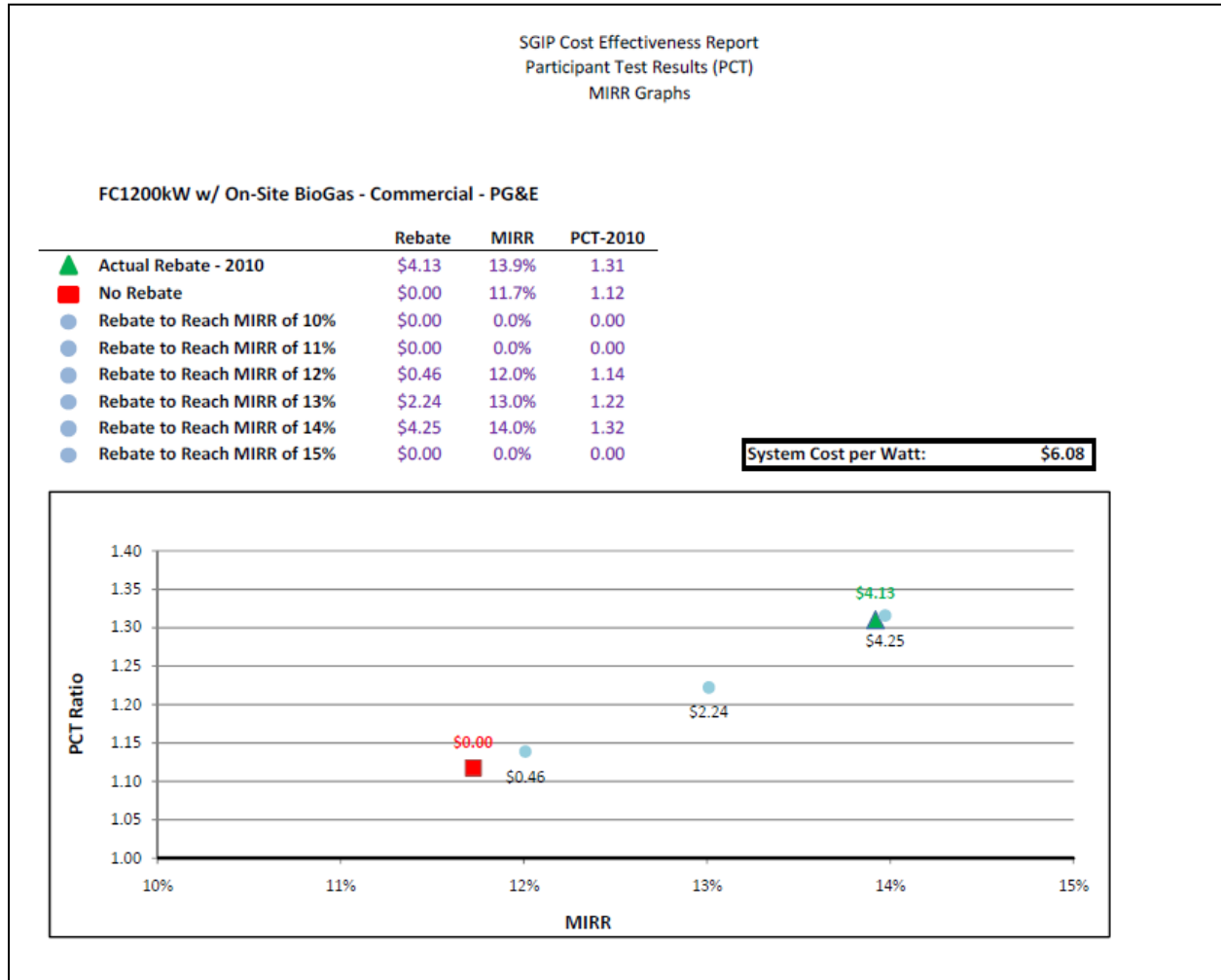

Based on a nominal size of 1,200 kW, fuel cells powered by on-site biogas and using waste heat recovery have a PCT ratio of 1.12 in 2010 without an incentive (with an associated MIRR of 11.7%). Fuel cells in this size range and fueled by on-site biogas pass the PCT test without an incentive given the input assumptions used in the Base Scenario. Within the SGIP, a fuel cell charged with on-site biogas and sized at 1,200 kW would be eligible to receive an incentive of \$4.13/Watt. At that incentive level, the PCT ratio would increase to 1.31 and the corresponding MIRR would be 13.9%. Increasing the incentive from \$4.13/Watt to \$4.45/Watt increases the

MIRR from 13.9% to 14%. Incentives were not calculated above an MIRR of 14% as the amount of incentive required would exceed the cost of the measure.

Comparing the PCT/MIRR findings for CHP fuel cells with no incentives, systems fueled by on-site biogas have a higher PCT/MIRR level (1.12) than those fueled by directed biogas (0.97) and systems fueled by natural gas have the lowest PCT/MIRR levels (1.02). Systems fueled by on-site biogas do not need to purchase fuel and are eligible to sell RECs beginning in 2013. The elimination of fueling costs in addition to the REC benefits works to offset the higher system and O&M costs for on-site biogas relative to natural gas-fueled systems.

At the current SGIP incentive level (\$4.13/Watt), the PCT for on-site biogas fuel cells is 1.31 while the MIRR is 13.9%.¹⁷ Fuel cell systems powered by directed biogas have an estimated PCT of 1.132 and an MIRR of 13.1% under the current program, while natural gas-fueled systems have a PCT of 1.126 and an MIRR of 12.5% at the current rebate of \$2.29/Watt.¹⁸ The PCT/MIRR is highest for on-site biogas systems due to the benefit of a substantial rebate, no fueling costs, and the receipt of a REC, which more than compensates for the higher system and O&M costs. The directed biogas system has a PCT that is essentially equal to the PCT for the natural gas system due to the biogas system having a larger rebate and receiving a REC, which just compensates for the higher fueling costs of the directed biogas system relative to the natural gas system.

¹⁷ The fuel cell incentive of \$4.13/Watt is a weighted incentive of \$4.5/Watt for the first MW and \$2.25/Watt for 200 kW.

¹⁸ The natural gas fuel cell incentive of \$2.29/Watt is a weighted incentive of \$2.5/Watt for the first MW and \$1.25/Watt for 200 kW. Note the PCT test values presented in the text were not rounded while those in the tables were rounded.

5.2.3 Gas Turbine Results

Gas Turbines in the 2 to 5 MW Size Range

Figure 5-20 illustrates the effect of changing the incentive level on the MIRR for gas turbines nominally sized at 3,500 kW, fueled by natural gas in PG&E’s service territory under the Base Scenario.

Figure 5-20: PCT Results for Gas Turbines 2 to 5 MW, Natural Gas (PG&E)

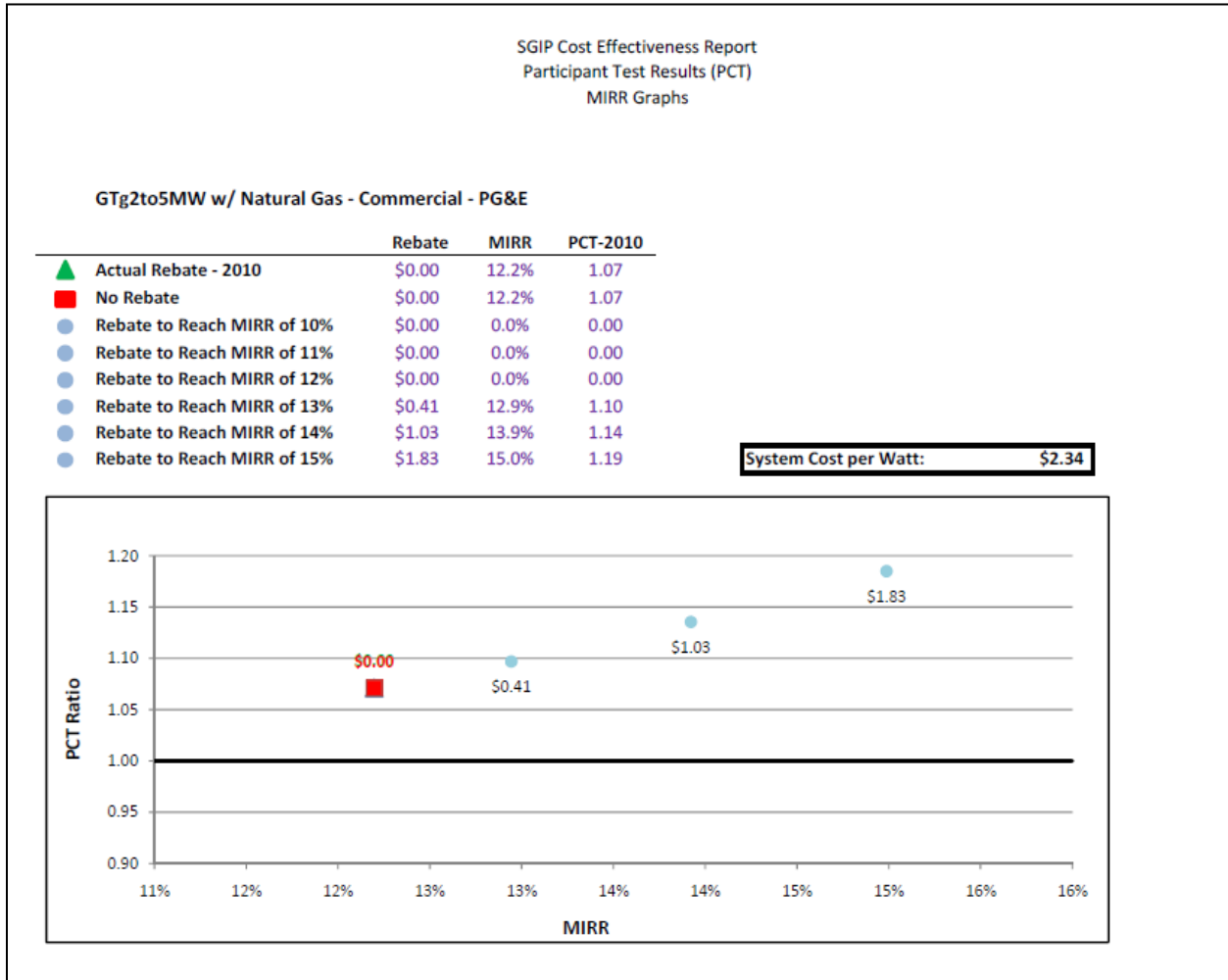

Gas turbines at a nominal capacity of 3,500 kW and powered by natural gas have an estimated PCT ratio of 1.07 in 2010 without an incentive (with an associated MIRR of 12.2%). In 2010, gas turbines were not eligible to receive incentives under the SGIP. Consequently, incentives were applied to the measure to increase the MIRR to 13%, 14%, and 15%. To reach an MIRR of 13% required a program rebate of \$0.41/Watt. An MIRR of 14% is associated with an incentive of \$1.03/Watt, while an MIRR of 15% requires a \$1.83/Watt incentive.

Figure 5-21 illustrates the effect of changing the incentive level on the MIRR for gas turbines nominally sized at 3,500 kW, fueled by directed biogas in PG&E’s service territory under the Base Scenario.

Figure 5-21: PCT Results for Gas Turbines 2 to 5 MW, Directed Biogas (PG&E)

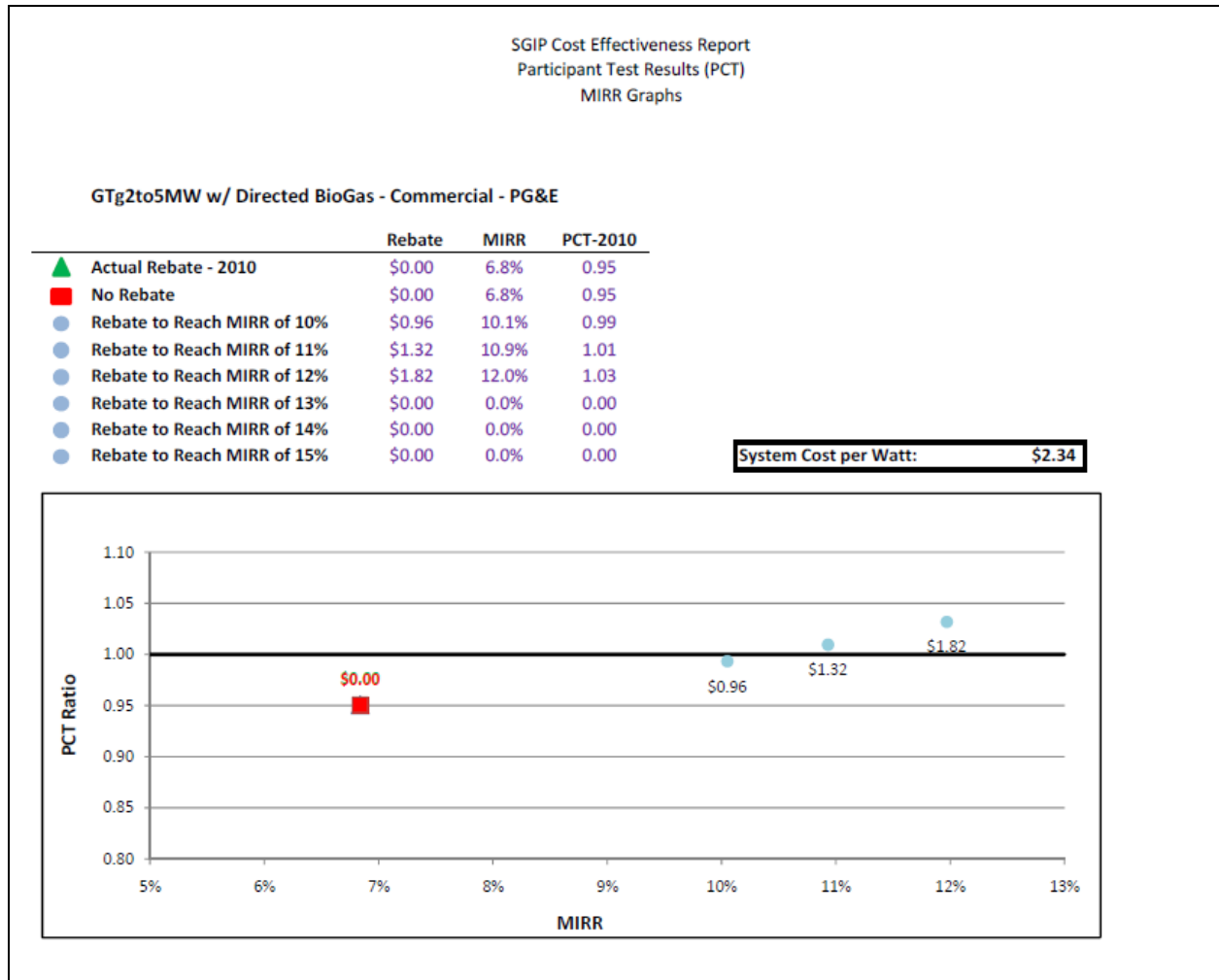

Gas turbines at a nominal capacity of 3,500 kW and powered by directed biogas have an estimated PCT ratio of 0.95 in 2010 without an incentive (with an associated MIRR of 6.8%). In 2010, gas turbines were not eligible to receive incentives under the SGIP. Consequently, incentives were applied to the measure to increase the MIRR to 10%, 11%, and 12%. To reach an MIRR of 10% required a program rebate of \$0.96/Watt. An MIRR of 11% is associated with an incentive of \$1.32/Watt, while an MIRR of 12% requires a \$1.82/Watt incentive. Incentives were not calculated above an MIRR of 12% as the amount of incentive required would exceed the cost of the measure. The higher fueling cost of the direct biogas system when combined with

a larger sized turbine leads the system to be less cost-effective from the participant’s point of view than the natural gas system.

Figure 5-22 shows the effect of changing the incentive level on the MIRR for gas turbines nominally sized at 3,500 kW fueled by on-site biogas in PG&E’s service territory under the Base Scenario. In general, gas turbines in this size range and powered by on-site biogas pass the PCT by a wide margin. In this particular instance, even without an incentive, the technology shows an MIRR of 14.8%. Consequently, a small increase in incentive of only \$0.18/Watt is needed to move the MIRR level to 15%.

Figure 5-22: PCT Results for Gas Turbines 2 to 5 MW, On-site Biogas (PG&E)

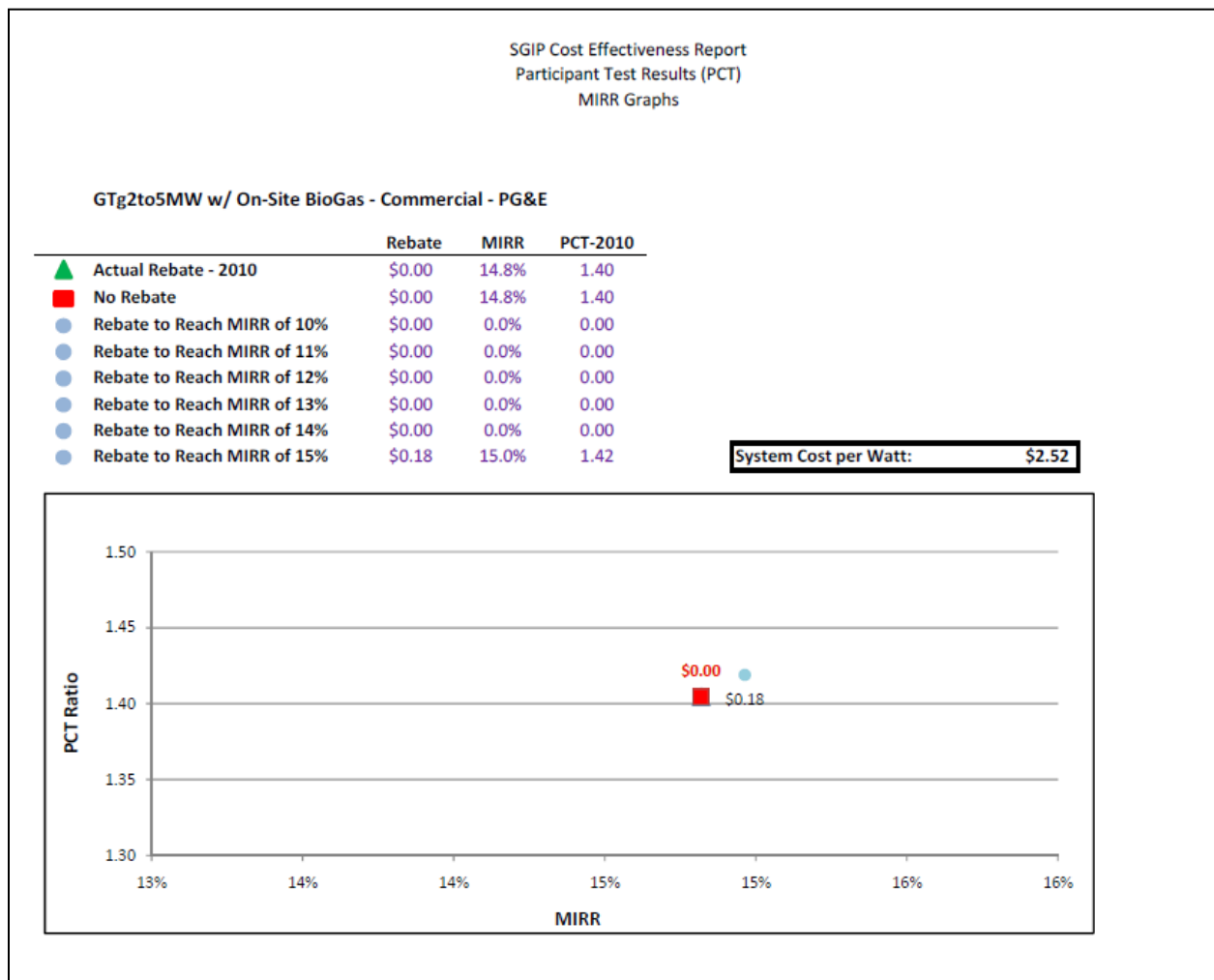

Gas turbines fueled by on-site biogas are more cost-effective from the participant’s point of view than those fueled by natural gas or directed biogas due to the high fueling cost

Gas Turbines in the Less Than 2 MW Size Range

Figure 5-23 shows the effect of changing the incentive level on the MIRR for gas turbines nominally sized at 1,000 kW fueled by natural gas in PG&E’s territory under the Base Scenario.

Figure 5-23: PCT Results for Gas Turbines < 2 MW, Natural Gas (PG&E)

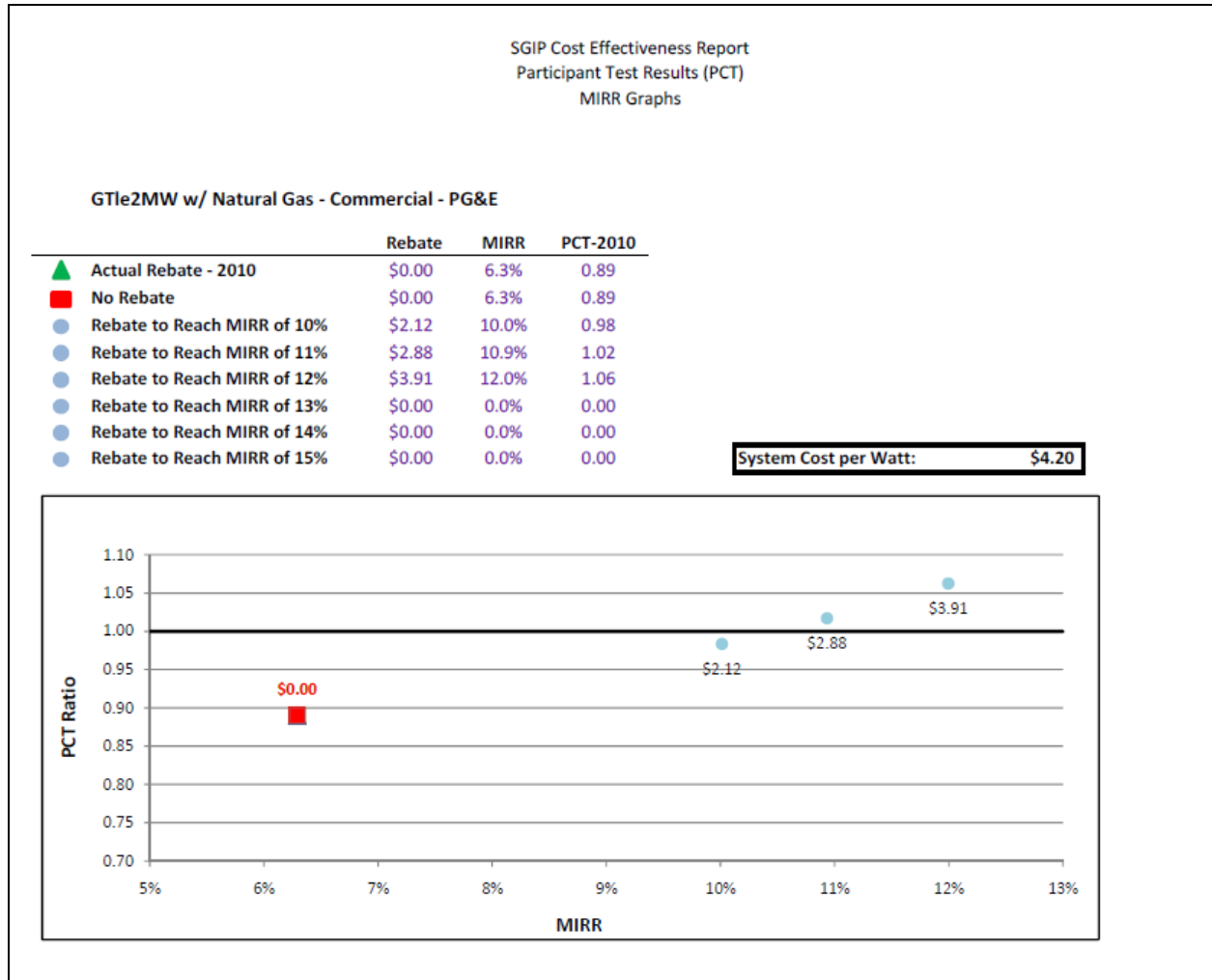

Gas turbines at a nominal capacity of 1,000 kW and powered by natural gas show a PCT ratio of 0.89 in 2010 without an incentive (with an associated MIRR of 6.3%). In 2010, gas turbines were not eligible to receive incentives under the SGIP. Consequently, incentives were calculated starting at an associated MIRR level of 10%. At an MIRR of 10%, the technology had a PCT ratio of 0.98 with an incentive of \$2.12/Watt. At 11% MIRR, the PCT ratio increases to 1.02 and the corresponding incentive level is \$2.88/Watt. If incentives were increased to \$3.91/Watt, the MIRR would rise to 12% and the PCT would be 1.06. The required incentive to reach an MIRR above 12% was not calculated as the amount of incentive required would exceed the cost of the measure.

Figure 5-24 shows the effect of changing the incentive on the MIRR for gas turbines nominally sized at 1,000 kW fueled by directed biogas in PG&E’s service territory under the Base Scenario.

Figure 5-24: PCT Results for Gas Turbines < 2 MW, Directed Biogas (PG&E)

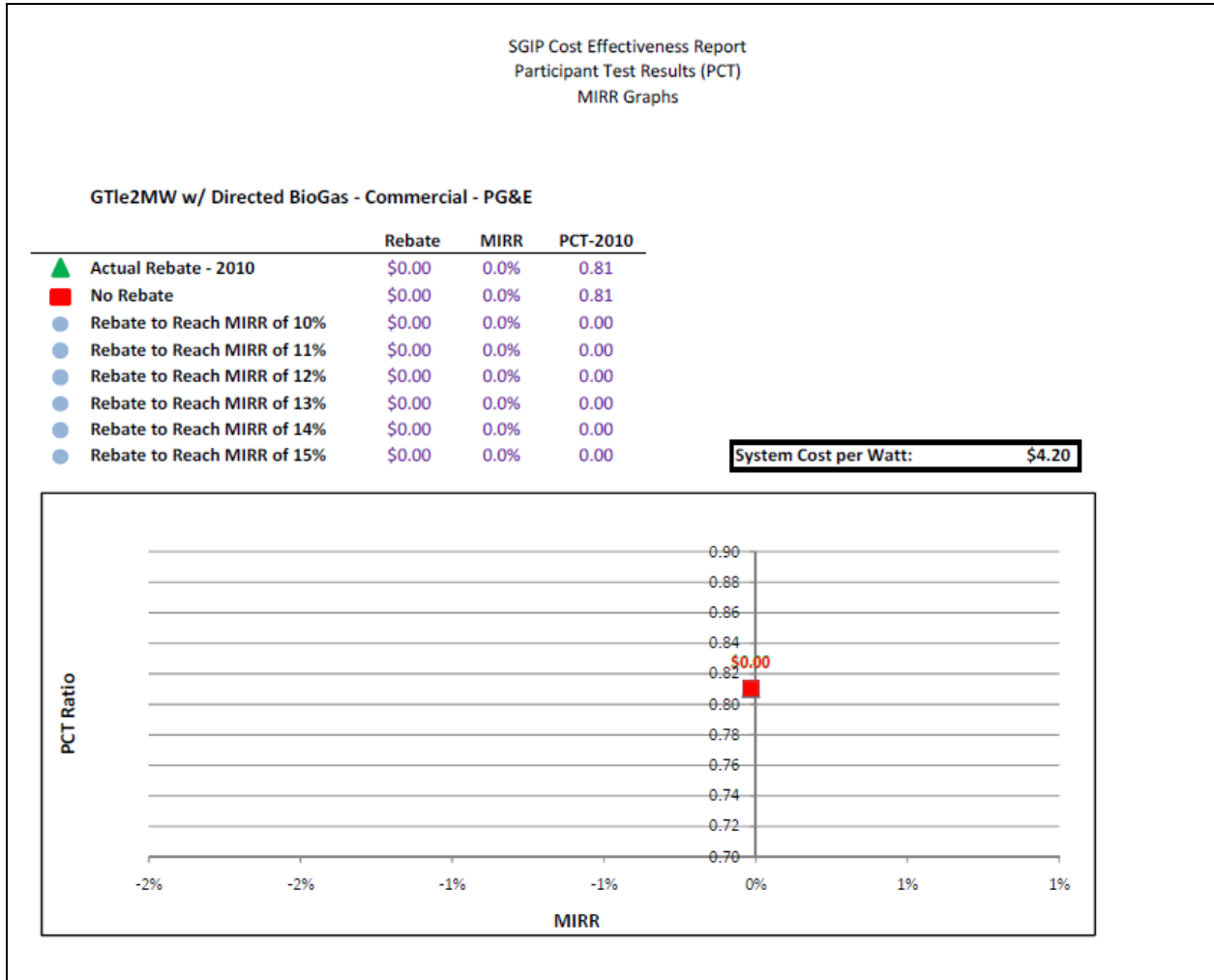

As illustrated in Figure 5-24, without a rebate, the PCT was 0.81 and the MIRR was 0.0%. It was not possible to reach a 10% MIRR level without providing a rebate in excess of the measure costs. Consequently, the only point shown in the chart reflects the MIRR level of 0.0% associated with no incentive.

Figure 5-25 shows the effect of changing the incentive level on the MIRR for gas turbines nominally sized at 1,000 kW fueled by on-site biogas in PG&E’s service territory under the Base Scenario.

Figure 5-25: PCT Results for Gas Turbines < 2 MW, On-site Biogas (PG&E)

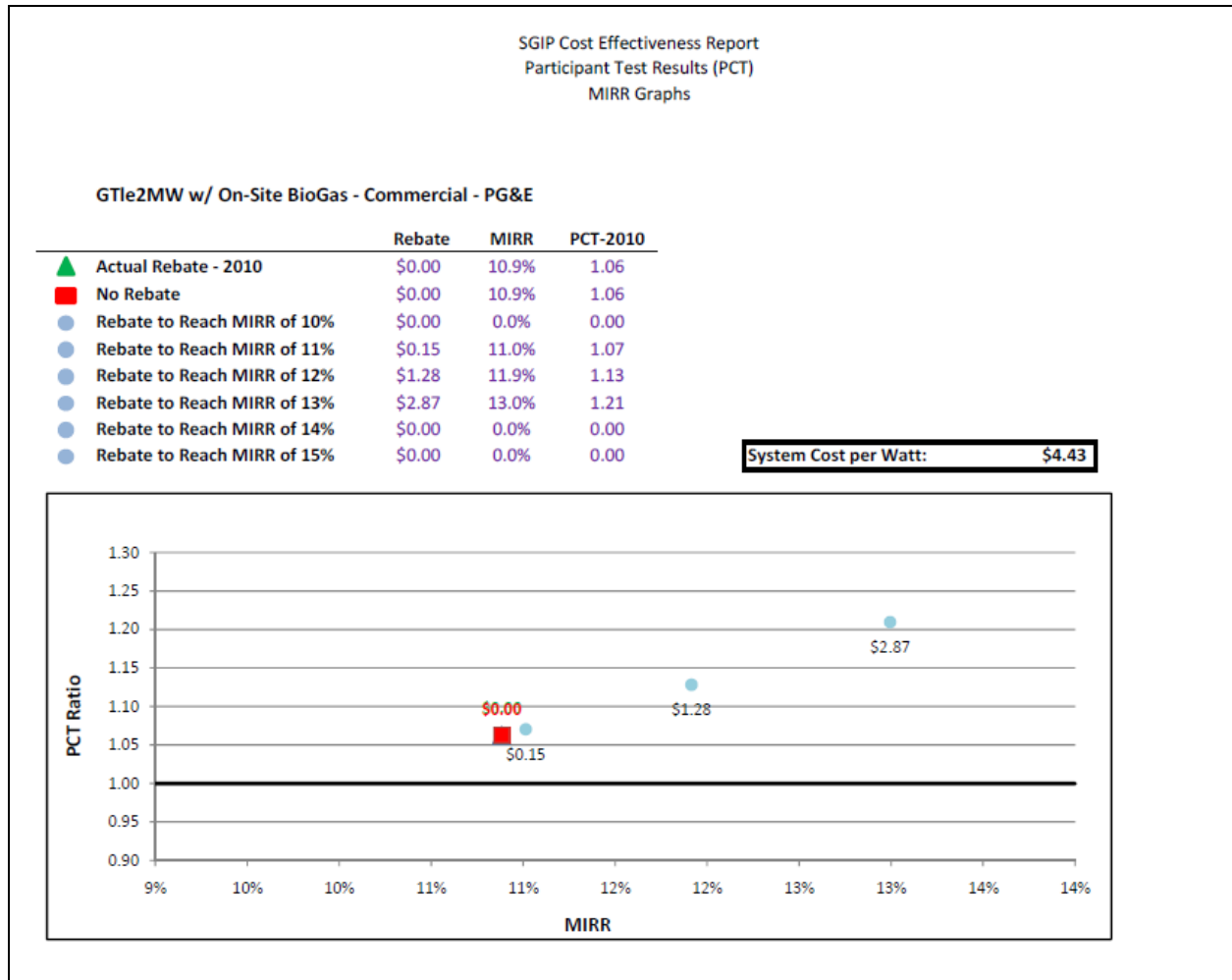

As with the larger-sized gas turbines, the 1,000 kW nominal gas turbine fueled by on-site biogas passes the PCT without an incentive and shows an MIRR of 10.9%. Incentives were increased to reach an 11% MIRR (which had an associated incentive level of \$0.15/Watt). Further increasing the incentive to \$1.28/Watt increases the MIRR to 12% and the PCT to 1.13. With an incentive of \$2.87/Watt, the MIRR is 13% and the PCT is 1.21. No further MIRR runs were conducted as the associated incentives would exceed the cost of the measure.

The on-site biogas 1,000 kW turbine is the only smaller gas turbine with a PCT greater than 1.0. The on-site biogas system benefits from the receipt of a REC in 2013 and beyond and is not

subject to fueling costs. These benefits more than compensate for the higher system and O&M costs of the on-site biogas system relative to the natural gas and directed biogas systems.

The smaller gas turbine is generally less cost-effective from the participant’s point of view than the larger gas turbine. The lower PCT values for the smaller gas turbine are consistent with the STRC results, which also found lower values for the smaller turbine. The system cost of the smaller turbine is high relative to the estimated electricity savings from these systems when compared to the system cost and electricity savings from the larger turbines.

5.2.4 Microturbine Results

Figure 5-26 shows the effect of changing the incentive levels on the MIRR for microturbines nominally sized at 200 kW fueled by natural gas in PG&E’s service territory under the Base Scenario.

Figure 5-26: PCT Results for Microturbines at 200 kW, Natural Gas (PG&E)

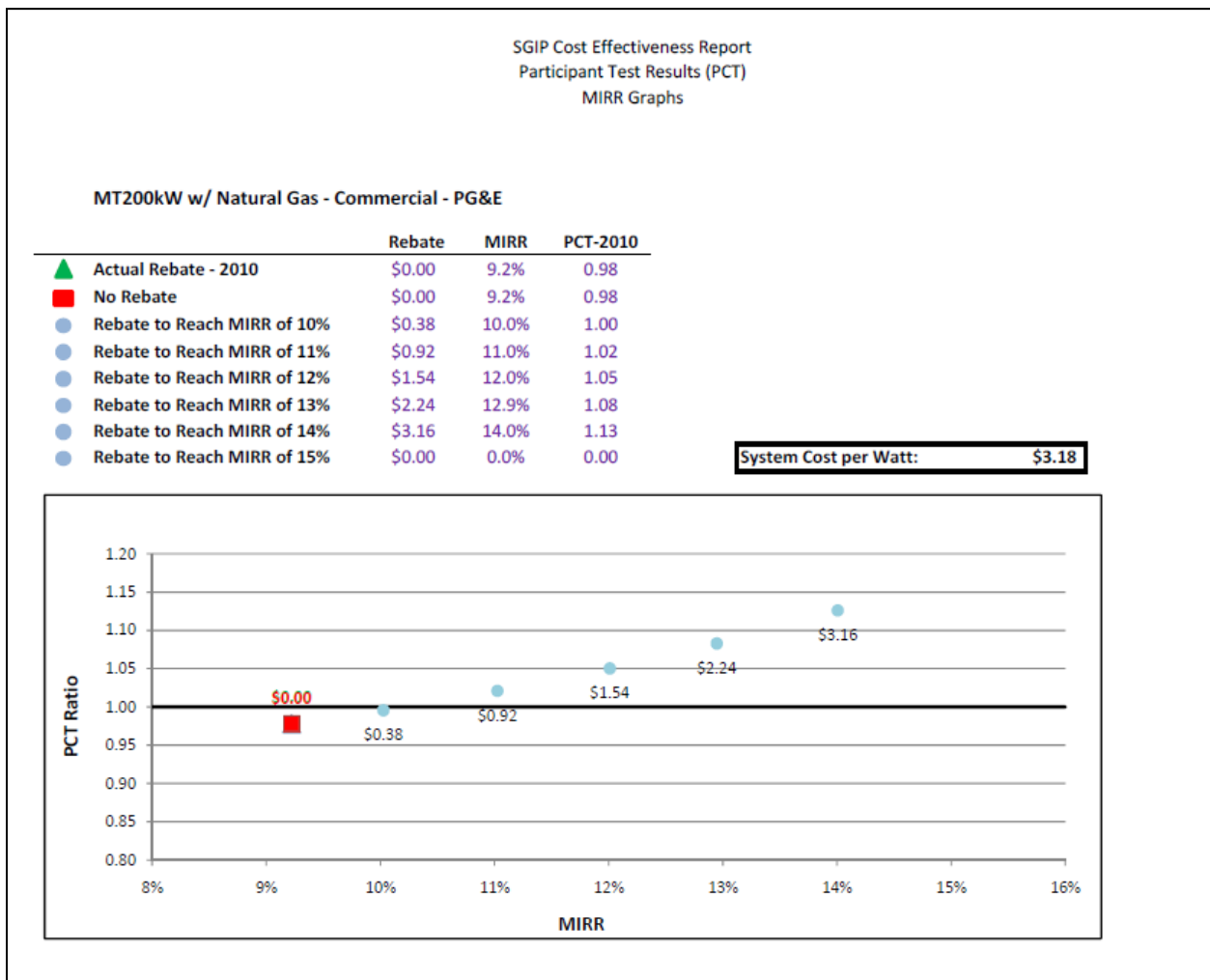

As shown in the chart, microturbines at a nominal size of 200 kW are very close to passing the PCT without an incentive. Under the current SGIP, microturbines do not receive a rebate and the estimated PCT is 0.98 and the MIRR is 9.2%. Increasing incentives to \$0.38/Watt increased the MIRR to 10% and the PCT to 1.0. To reach an MIRR of 11% required a rebate of \$0.92/Watt, for a 12% MIRR a rebate of \$1.54 was required, \$2.24/Watt for 13% MIRR and \$3.16/Watt for 14% MIRR. Incentive levels topped out at \$3.15/Watt and an associated 14% MIRR.

Figure 5-27 shows the effect of changing the incentive on the MIRR for microturbines nominally sized at 200 kW fueled by directed biogas in PG&E territory under the Base Scenario. For this technology and fuel combination, it was not possible to achieve a 10% MIRR level without having the incentive exceed the cost of the measure. Given the relatively low level of energy production from a microturbine, the system does not produce enough energy to overcome the high cost of fueling with directed biogas.

Figure 5-27: PCT Results for Microturbines at 200 kW, Directed Biogas (PG&E)

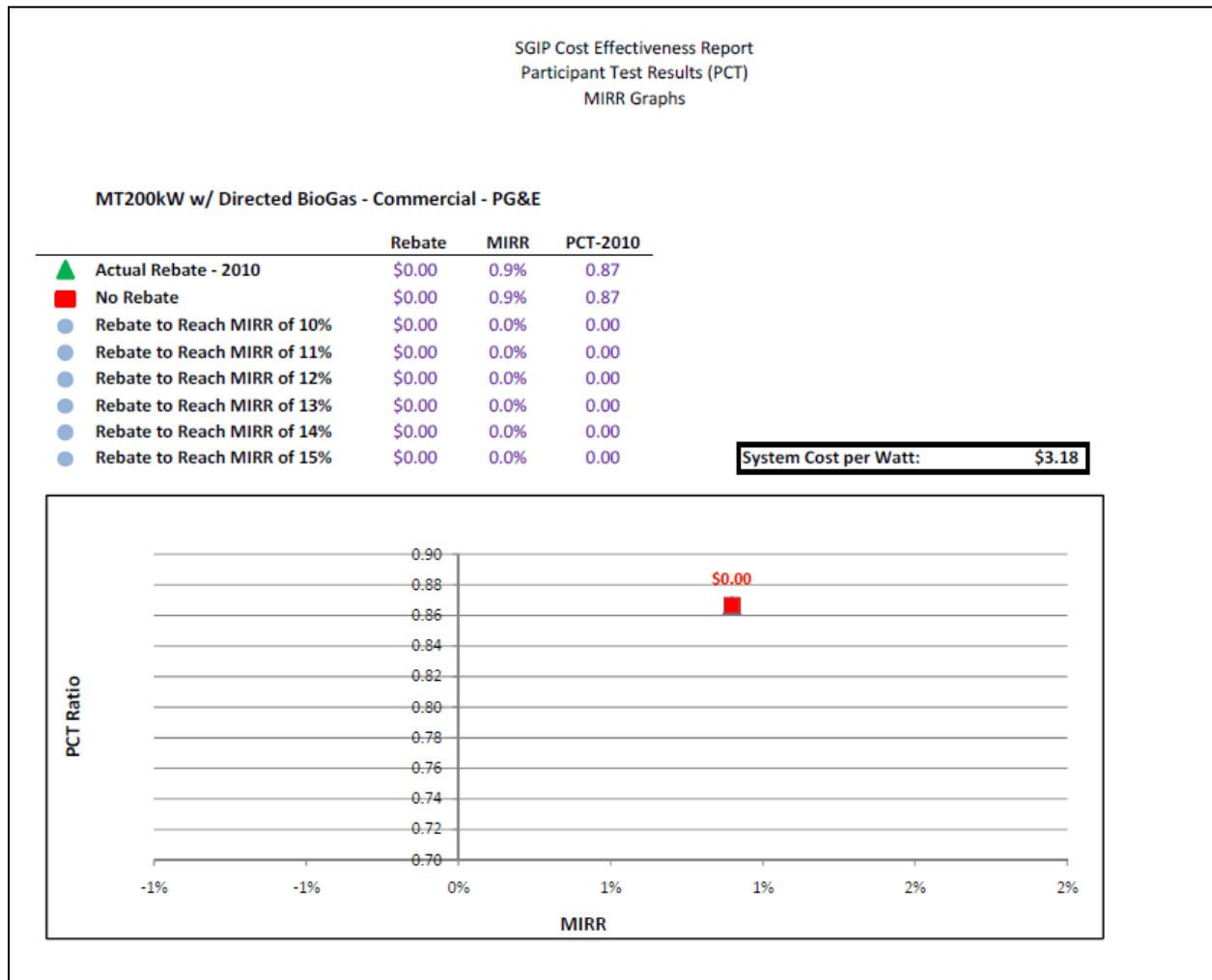
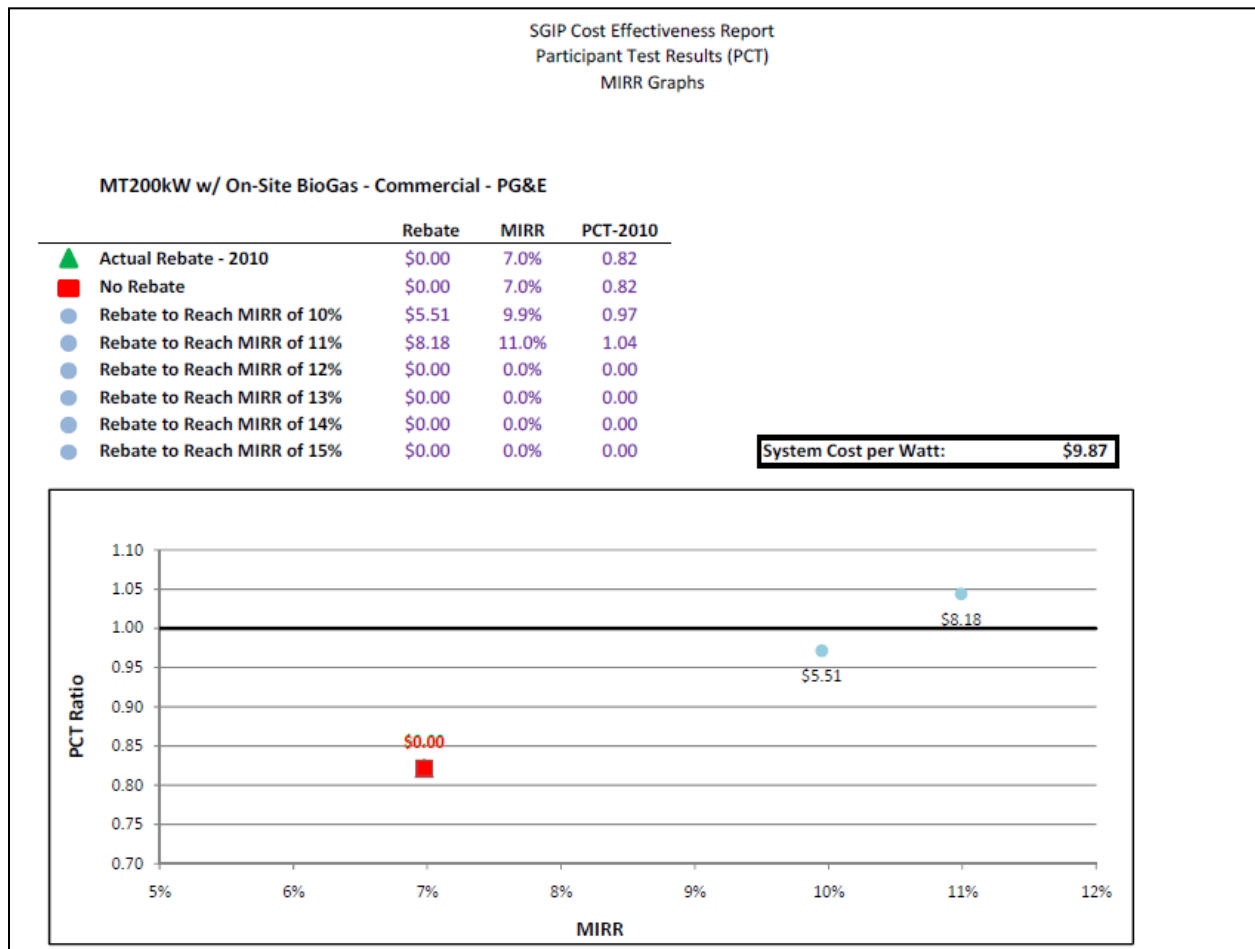

Figure 5-28 shows the effect of changing the incentive on the MIRR for microturbines nominally sized at 200 kW fueled by on-site biogas in PG&E territory under the Base Scenario. Microturbines at this nominal size range fueled by on-site biogas have a difficult time passing the PCT and require significant levels of incentives to achieve MIRR levels above 10%. Without an incentive, a 200 kW microturbine fueled by on-site biogas shows a PCT of 0.82 and an MIRR of 7.0%. To get to an MIRR level of 10%, a participant using this technology and fuel combination would need an incentive of \$5.51/Watt. Similarly, moving up to an MIRR level of 11% would require an incentive of \$8.18/Watt.

Figure 5-28: PCT Results for MT at 200 kW, On-site Biogas (PG&E)



Microturbines are modeled with a capacity of 200 kW. The relatively small capacity limits the monetary value of the electric and gas bill reduction achievable with a microturbine. For a microturbine to be cost-effective from the participant’s point of view, the cost of fueling the system must be relatively low or other benefits such as incentives or RECs must be available. Microturbines fueled with natural gas are approximately cost-effective under the PCT without a rebate (PCT = 0.98). Microturbines fueled with directed biogas are not cost-effective from the

participant’s viewpoint without an incentive that exceeds the system costs. The fueling cost for directed biogas is too expensive for the small system size. Systems fueled by on-site biogas are cost-effective under the PCT with a significant rebate. Systems fueled with on-site biogas, however, are cost-effective from society’s point of view due to the high GHG benefit associated with the methane capture (STRC = 1.24).

5.2.5 IC Engine Results

IC Engines at 500 kW Nominal Capacity

Figure 5-29 shows the PCT and MIRR results for IC engines at a nominal 500 kW capacity fueled by natural gas. As shown, the IC engine with this capacity and fuel combination passes the PCT significantly and is cost-effective from the participant point of view. The PCT ratio was 1.18 in 2010 without incentives and had a corresponding MIRR of 14.5%. An incentive of \$0.31/Watt is needed to reach an MIRR of 15%. The relatively low cost of IC engine systems and the low fueling cost of natural cost contribute to the cost-effectiveness of these systems.

Figure 5-29: PCT Results for IC Engines at 500 kW, Natural Gas (PG&E)

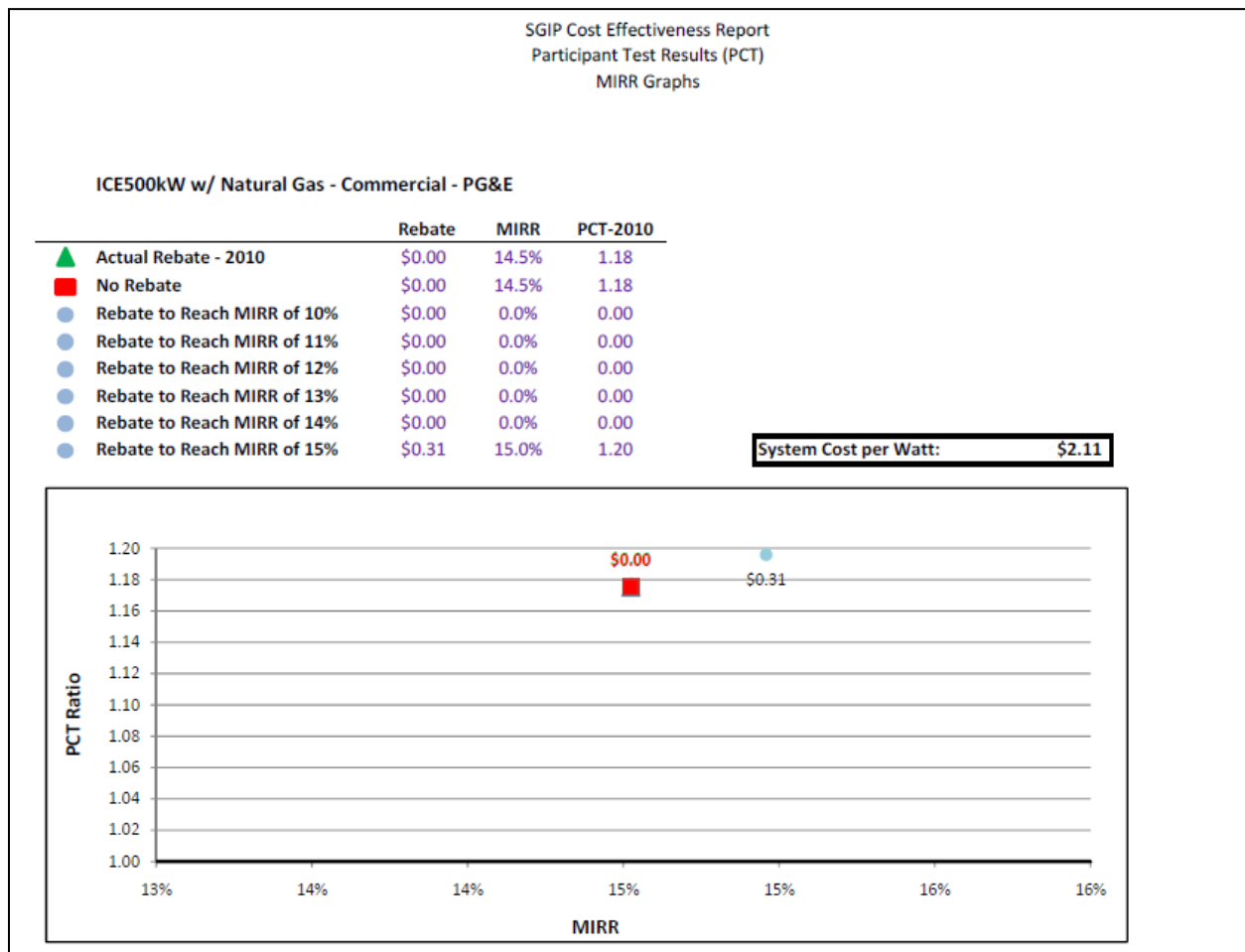

Figure 5-30 shows the impact of changing incentive levels on the MIRR and PCT for an IC engine with a nominal capacity of 500 kW fueled with directed biogas in PG&E’s service territory under the Base Scenario. The PCT ratio was 1.02 in 2010 without incentives with a corresponding MIRR of 11%. At incentive levels of \$0.39 and \$0.92/Watt, the MIRR increased to 12% and 13% respectively with corresponding PCT ratios of 1.04 and 1.06. To reach an MIRR of 14% requires a rebate of \$1.47/Watt. Directed biogas has similar operational characteristics to natural gas, but a higher fuel cost associated with the gas clean-up and processing. The higher fuel costs are partially offset in the model with REC sales after 2013.

Figure 5-30: PCT Results for IC Engines at 500 kW, Directed Biogas (PG&E)

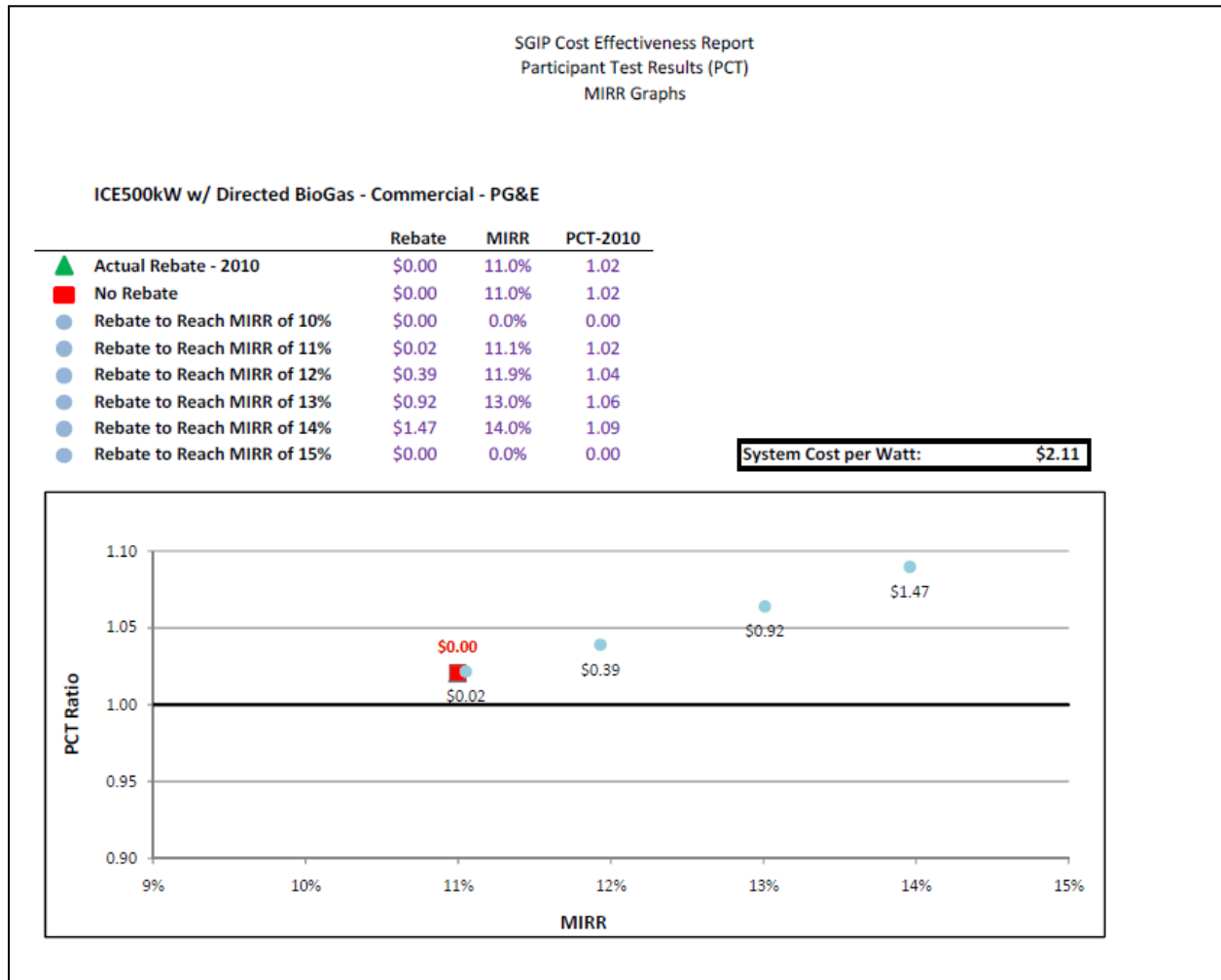
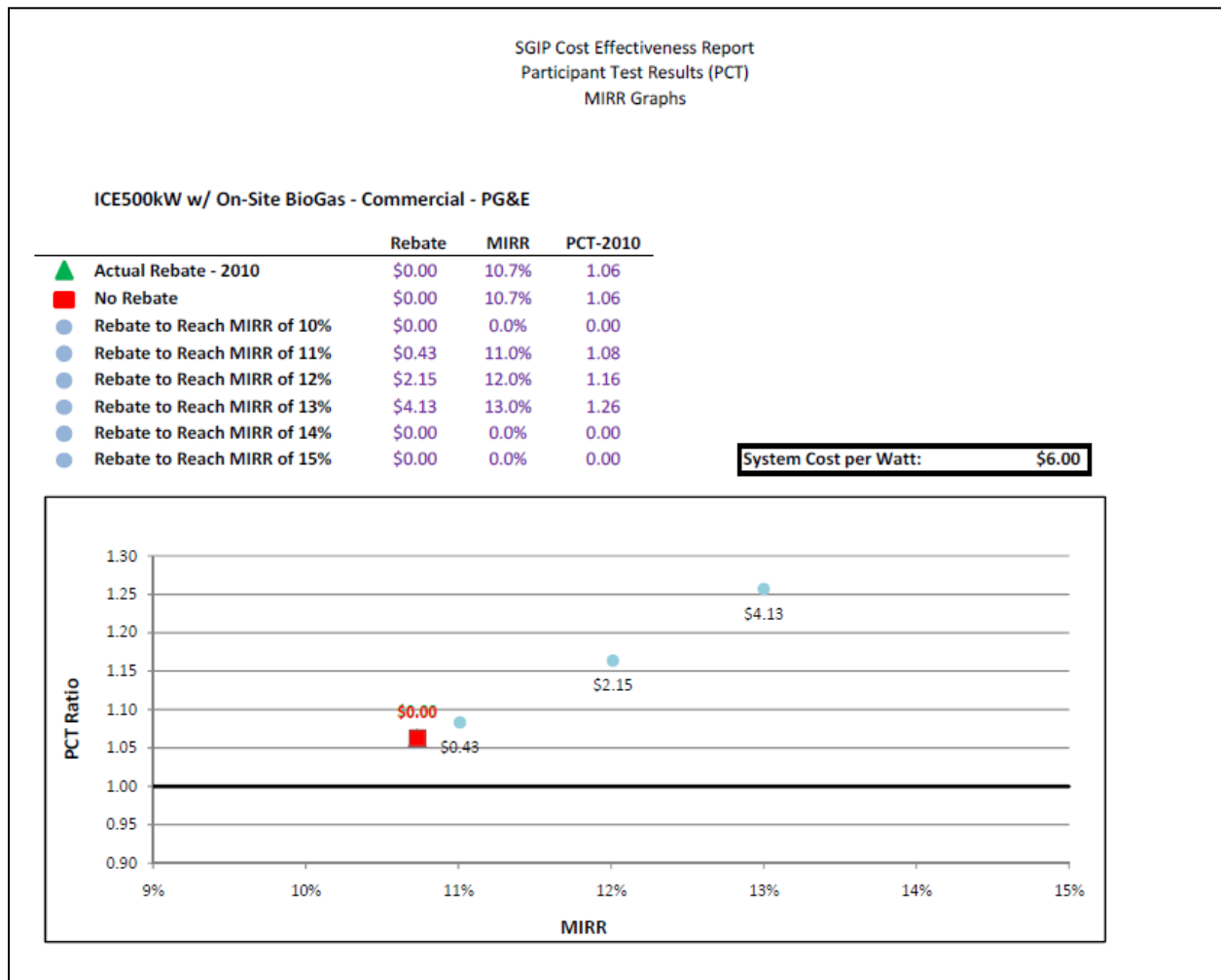

Figure 5-31 shows the impact of changing incentive levels on the MIRR and PCT for an IC engine with a nominal capacity of 500 kW fueled with on-site biogas in PG&E’s service territory under the Base Scenario. In this situation, elimination of on-going fuel costs and revenue from REC sales appear to more than offset the increased capital and operating costs associated with on-site biogas. Without an incentive, the system has a PCT of 1.06 and an MIRR of 10.7%. To reach an MIRR of 11% requires a rebate of \$0.43/Watt, \$2.15/Watt for an MIRR of 12%, and \$4.13/Watt for a 13% MIRR. To reach an MIRR of 14% would have required a rebate in excess of the system costs.

Figure 5-31: PCT Results for IC Engines at 500 kW, On-site Biogas (PG&E)



IC engines are relatively low-cost technologies. The smaller system cost contributes to the participant cost-effectiveness of the technologies fueled by natural gas, directed biogas, or on-site biogas.

IC Engines at 1,500 kW Nominal Capacity

Figure 5-32 shows the relationships between incentives and PCT/MIRR levels for an IC engine nominally rated at 1,500 kW fueled by natural gas in PG&E’s service territory under the Base Scenario. Without an incentive, the 1,500 kW IC engine has an MIRR of 15.8% and a PCT of 1.24 in 2010. As modeled within this evaluation, the 1,500 kW IC engine is very cost-effective from the participant’s point of view without incentives from SGIP.

Figure 5-32: PCT Results for IC Engines at 1,500 kW, Natural Gas (PG&E)

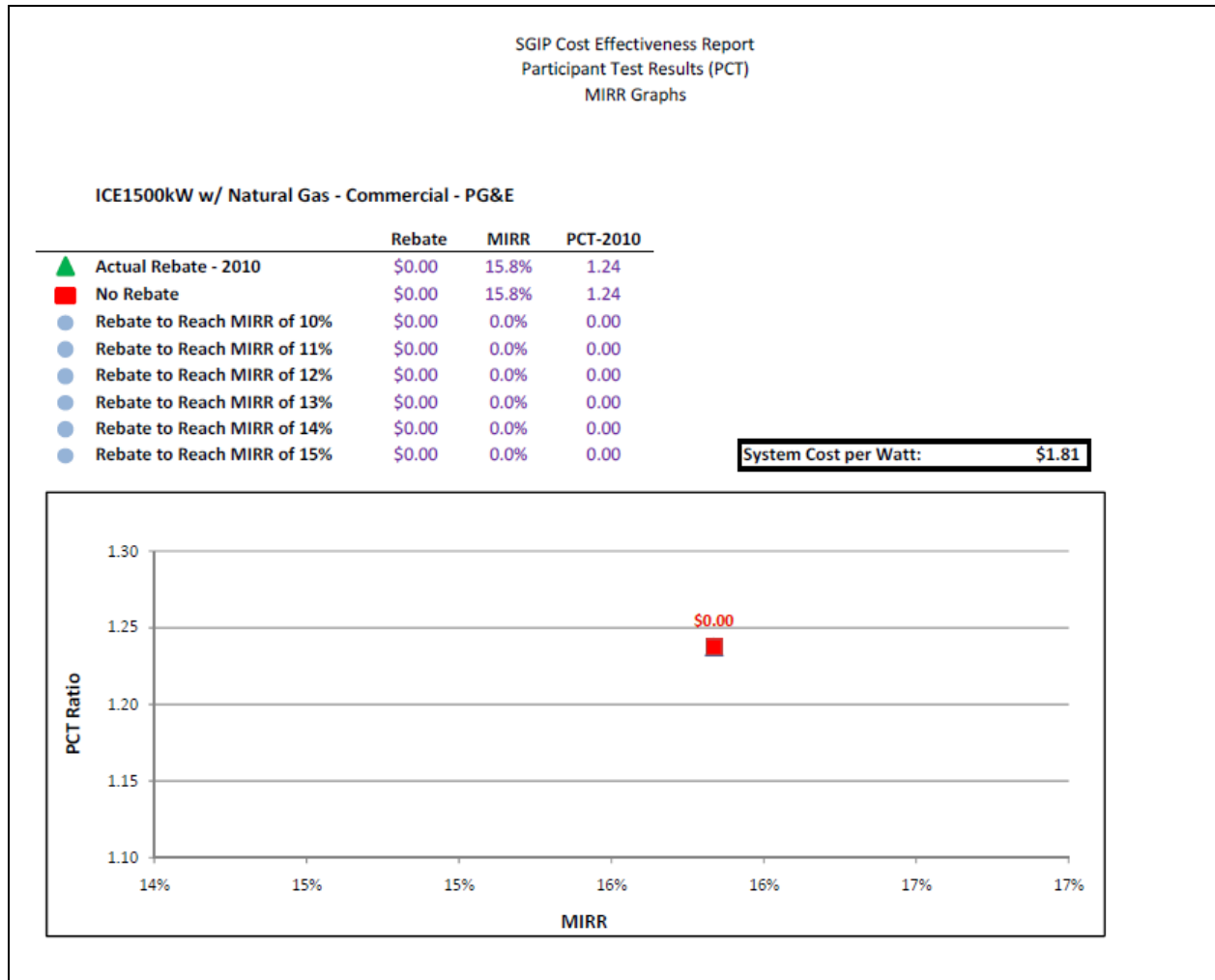

Figure 5-33 shows the impact of changing incentive levels for an IC engine nominally rated at 1,500 kW and fueled with directed biogas. The PCT ratio was 0.97 with a corresponding MIRR of 6.8%. This case fails to pass the PCT test. With an incentive of \$0.55, the PCT ratio is 1.00 and the MIRR is 10.1%. Increasing the incentive level to \$0.78 and \$1.05 increases the MIRR to 11% and 12%, respectively, with corresponding PCT ratios of 1.01 and 1.02. Though directed biogas has similar characteristics to natural gas, the higher clean-up and processing costs are not significantly offset by the REC sales revenue in this case.

Figure 5-33: PCT Results for IC Engines at 1,500 kW, Directed Biogas (PG&E)

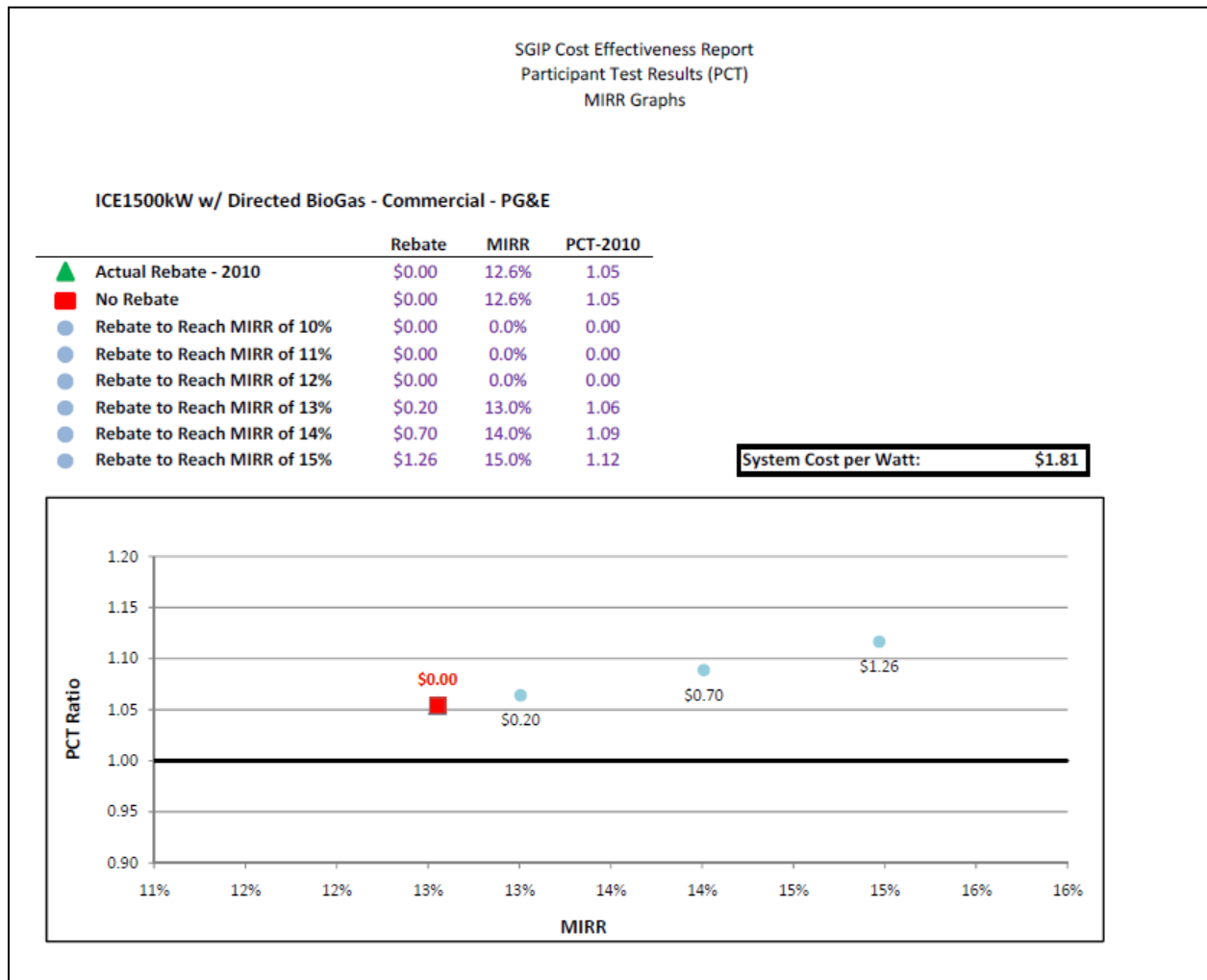
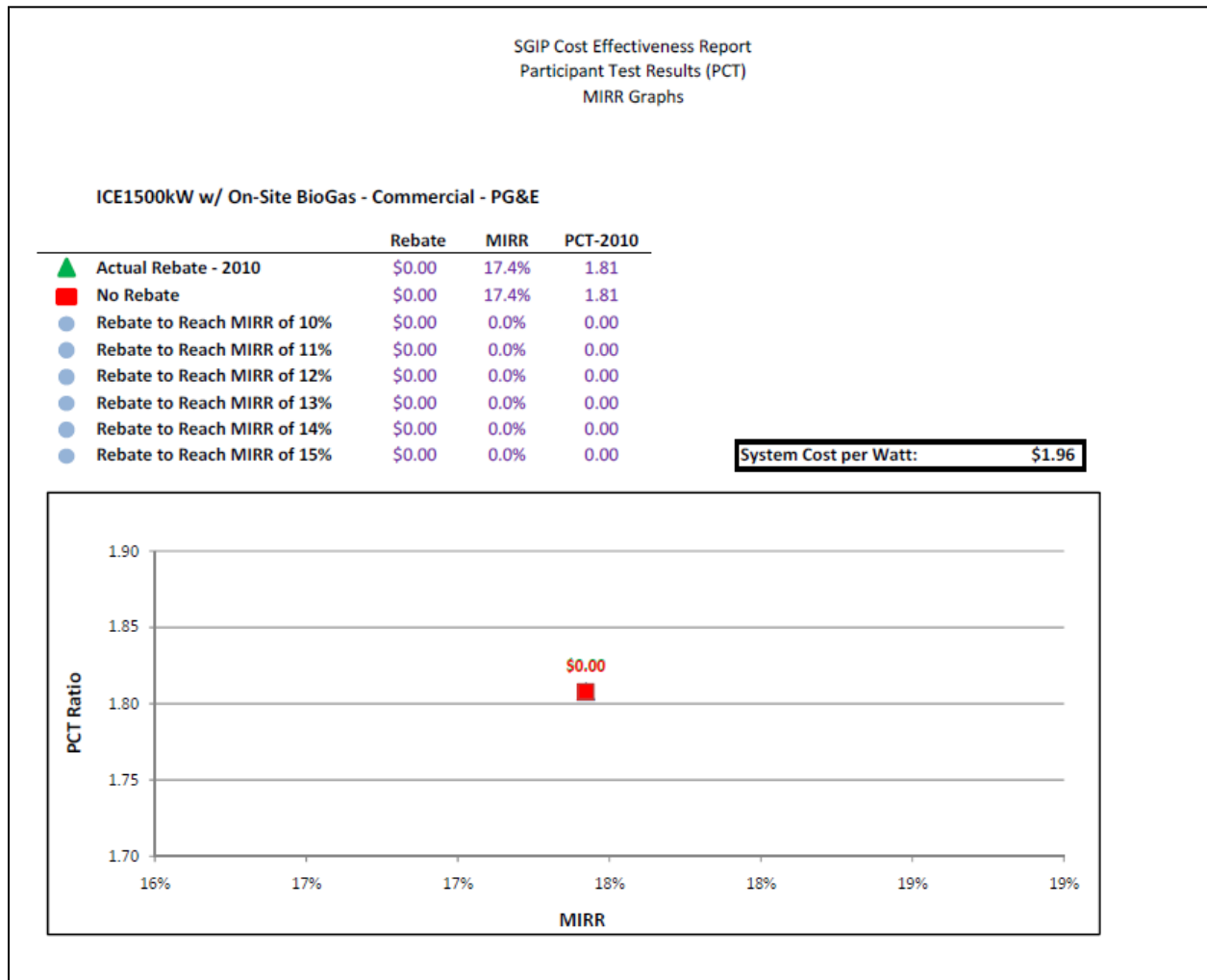

Figure 5-34 shows that, even without incentives, a biogas-fueled IC engine nominally rated at 1,500 kW is cost-effective as measured by the PCT ratio. The PCT ratio was 1.81 in 2010 with a corresponding MIRR of 17.4%. Despite higher capital cost associated with the capture and clean-up capital relative to the natural gas or directed biogas 1,500 kW IC engine, the PCT ratio is favorably high because of revenue from REC sales and the avoided fuel cost.

Figure 5-34: PCT Results for IC Engines at 1,500 kW, On-site Biogas (PG&E)



The 1,500 kW IC engine is modeled to be cost-effective from the participant’s point of view without incentives from SGIP. These systems have relatively low system costs (see Section 3 for information on all system costs), contributing to their higher PCT ratios.

5.2.6 Wind Results

SGIP encourages installation of wind turbines to generate electricity to serve a nearby facility’s electrical load. Wind turbines are typically two- or three-bladed fan-like structures that spin as the wind blows past the blades. A horizontal shaft at the center of the fan then turns a generator.

The generator’s electrical output, when conditioned properly, may be fed into the grid. Turbines are usually atop tall towers where wind speeds can be much higher than near the ground. For this analysis, the SGIPce evaluation team used a 1 MW wind turbine.

Figure 5-35 shows the influence of changing incentive levels on the PCT and MIRR for a 1 MW wind turbine in PG&E’s territory under the Base Scenario. As shown, without an incentive the wind turbine has a 14.5% MIRR and a PCT of 1.62. The reason why we have not seen more wind turbines in the SGIP program could be related to other transaction costs, such as permitting. Using the current incentive of \$1.50/Watt, the MIRR is 16.4%, and the PCT is 1.98. An incentive of \$.036/Watt is associated with a 15% MIRR and 1.71 PCT.

Figure 5-35: PCT Results for Wind at 1 MW (PG&E)

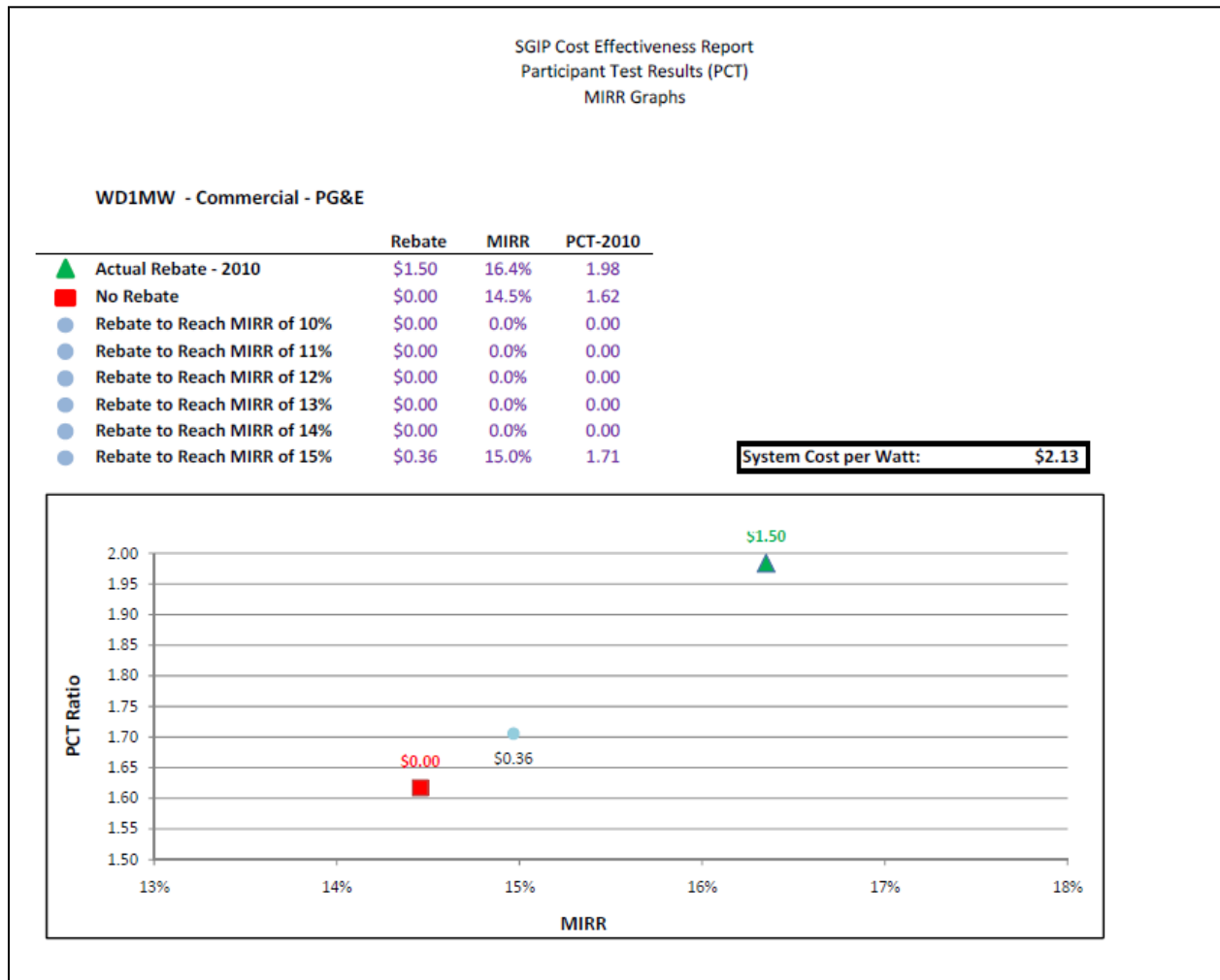

5.2.7 Organic Rankine Results

The Organic Rankine Cycle (ORC) is a thermodynamic cycle where waste heat from a high temperature industrial process, like glass manufacturing, is transferred to a fluid and is used to turn a turbine to create electricity. These bottoming cycle electrical generation plants are only used when the industrial process requires very high temperatures, so they are less common than other DG technologies. Figure 5-36 shows the impact of varying incentives on the PCT and MIRR for a 500 kW ORC unit in PG&E’s territory under the Base Scenario.

Figure 5-36: PCT Results for ORC at 500 kW (PG&E)

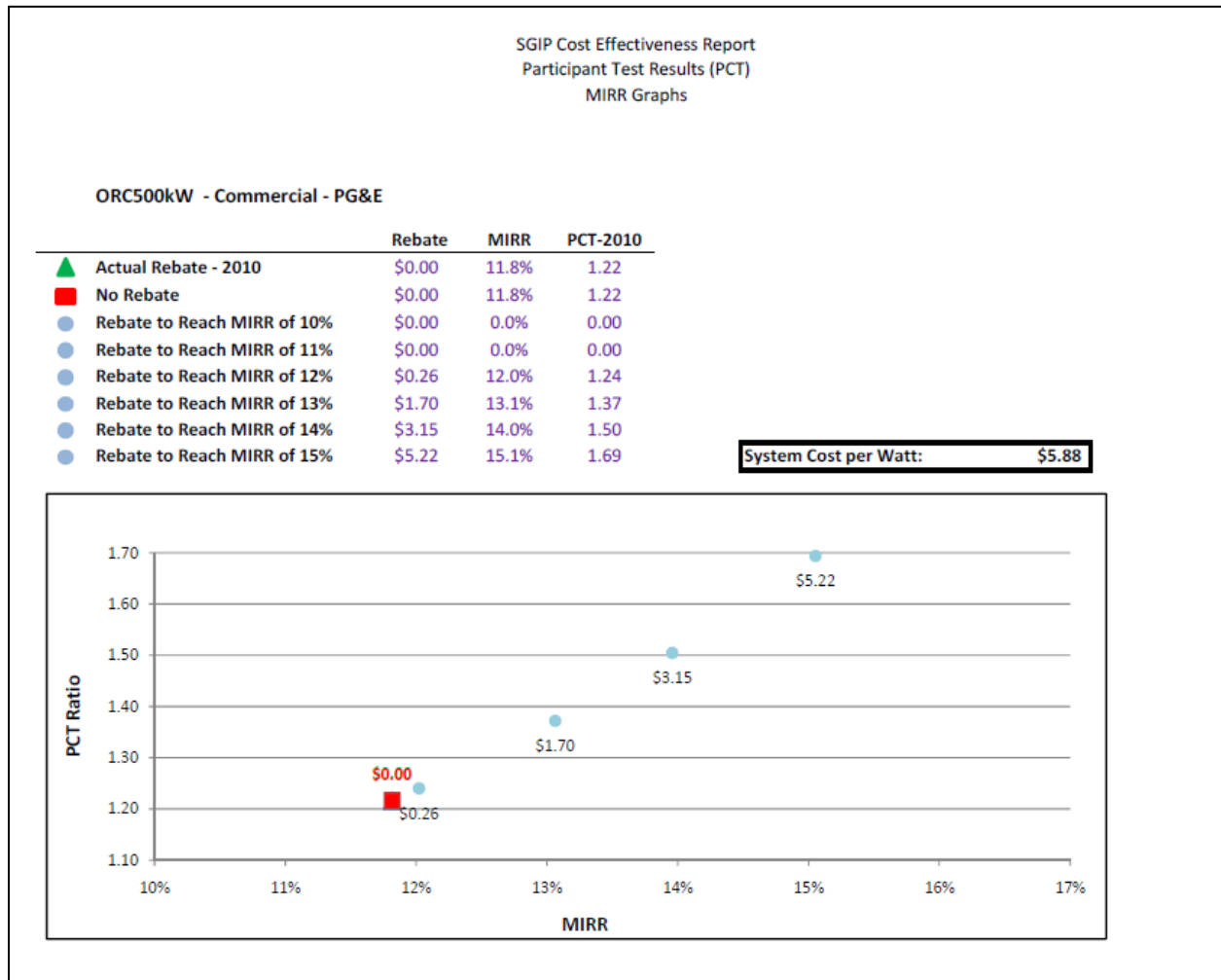

Currently ORCs do not receive an SGIP incentive. Without an incentive the ORC has a PTC of 1.22 and an MIRR of 11.8%. To reach a 12% MIRR, ORCs would need to receive an incentive of \$0.26/Watt. To reach a 13% MIRR and corresponding 1.37 PCT the incentive would need to be 1.70/Watt. Increasing the incentive to \$3.15/Watt increases the MIRR to 14% and an incentive of \$5.22/Watt is associated with a 15% MIRR. Capital costs of ORCs are material, but because the fuel is free, the MIRR and the PCT for this investment are favorable.

5.2.8 Storage Results

For storage we examined two sizes of storage systems: a 1 MW and a 25 kW lithium-ion system. The larger 1 MW system was set to maximize benefits by load shifting during the year using 8,760 avoided costs provided by E3. The 25 kW system was set up to maximize benefits of distribution deferral using 8,760 avoided costs.

The current SGIP rules require storage to be combined with an eligible technology (currently wind and fuel cells). In the SGIPce model we treated storage as a stand-alone technology in order to determine the cost impacts of storage systems.

Storage at 1 MW Size

Figure 5-37 shows the PCT results for the 1 MW storage system in PG&E's territory under the Base Scenario. Without an incentive the technology has a negative MIRR of -15.3% and a PCT of 0.52. With the current incentive of \$2.00/Watt, the MIRR is 4.6% and the PCT is 0.69. The evaluation team then ran the model with varying incentives to reach MIRR of 10% to 15%. No incentives were found to be suitable to reach an MIRR of 10% without exceeding the cost of the measure, therefore no incentives greater than the current incentives were evaluated.

Figure 5-37: PCT Results for Storage at 1 MW (PG&E)

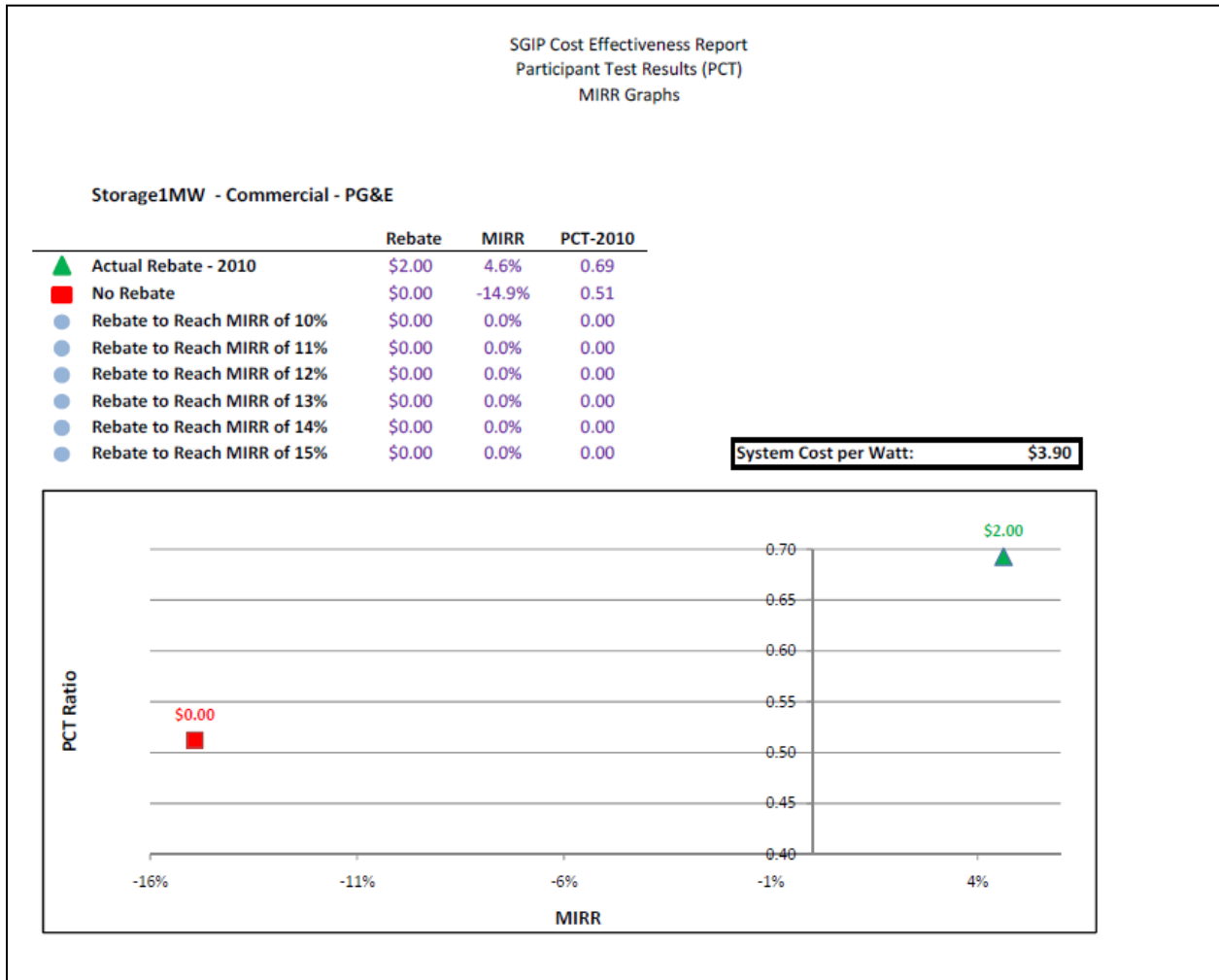

Storage at 25 kW Size

Figure 5-38 shows the PCT results for a 25 kW storage system in PG&E’s territory under the Base Scenario. Without an incentive the technology earns a negative MIRR of -14.1% and a PCT of 0.46. With the current incentive of \$2.00/Watt the MIRR is 1.8% and the PCT is 0.58. The evaluation team then ran the model with varying incentives to reach MIRR of 10% to 15%. No incentives were found to be suitable to reach an MIRR of 10% without exceeding the cost of the measure, therefore no incentives greater than the current incentives were evaluated.

Figure 5-38: PCT Results for Storage at 25 kW (PG&E)

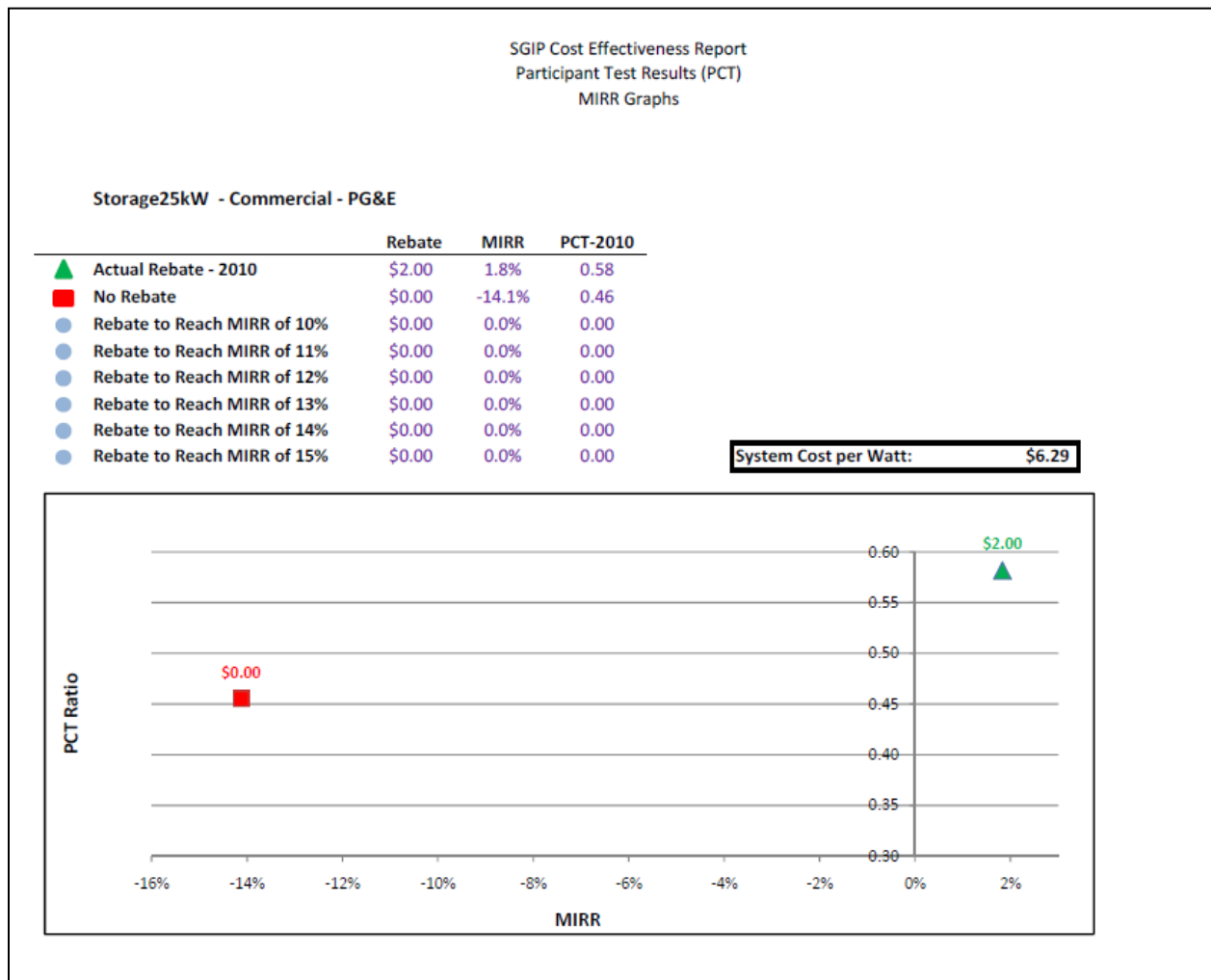

5.3 Comparing Societal Total Resource Cost and Participant Cost Test Results

Table 5-11 lists the STRC results for the commercial sector in 2016 and the PCT results for 2010 without incentives. Presenting the two different cost-effectiveness measurements side-by-side helps to clarify and compare which technologies are good for society and which technologies may need additional incentives to make them more attractive to participants. The results presented in Table 5-11 represent the cost-effectiveness of technologies in the commercial sector. The STRC results for 2016 are presented because SGIP is designed as a program incorporating market transformation and is currently planned to continue through 2016. The market transformation goals imply that the program may be willing to incent measures that are not cost-effective in 2010 if this support can help the measure become more cost-effective by 2016. The PCT results for 2010 are presented because SGIP needs to provide potential participants with the needed incentives to encourage technology adoption in the current and future periods.

The results presented in Table 5-11 show that all of the analyzed DG technologies other than storage are cost-effective or nearly cost-effective under the STRC when using the statewide electric sales weighted results. The STRC for storage is 0.59 and 0.66 for 25 kW and 1,000 kW systems, respectively. Small gas turbines (1,000 kW) are the only other technology with a STRC less than 1.0. The STRC for small gas turbines is 0.88-0.96, within a likely uncertainty range for the STRC given the 20-year forecast of avoided cost benefits needed to calculate the STRC.

Systems with the highest STRC include wind (1,000 kW) with a STRC of 1.72, microturbines fueled by on-site biogas at 1.52, IC engines (500 kW) fueled by on-site biogas at 2.39, IC engines (1,500 kW) fueled by on-site biogas at 1.72, and ORC with a STRC of 1.73. All of these systems share one commonality: the technologies are either fueled by on-site biogas or a non-cost fuel such as wind or process heat. All of the highest STRC systems have no fueling cost. The lack of a fueling cost also contributes to a higher-than average-PCT value for these systems. Wind has a PCT of 1.58, ORCs have a PCT of 1.19, IC engines (1,500 kW) have a PCT of 1.79, and IC engines sized to 500 kW have a PCT of 1.05. Only microturbines fueled by on-site biogas are not cost-effective to the participant (PCT = 0.82).

The relationship between the STRC and the PCT for microturbines deserves additional attention. The STRC for microturbines of 1.52 indicates that the societal benefits are 1.5 times as large as the societal costs. A large benefit in the STRC calculation is the monetized value of methane capture. Microturbines using on-site biogas were modeled as DG measures installed at sites that were previously venting methane. The installation of the technology leads to methane capture and a significant reduction in GHG emissions. The reduction in emissions attributed to methane capture by microturbines fueled by on-site biogas has a levelized value in STRC of slightly over \$100,000. The reduction in GHG emissions within the PCT is valued using RECs. RECs are

available to environmentally clean fuel systems and are based on the quantity of electricity produced, not the quantity of GHG reduction. Under this system, wind energy receives the same REC for a kWh of energy as microturbines fueled by on-site biogas and methane capture. The microturbine, however, has a much more substantial contribution to reducing GHG than the wind turbine. The levelized value of the REC for the microturbine fueled by on-site biogas within the PCT is slightly over \$22,000. The relatively small value of the emissions reduction within the PCT significantly contributes to the measure's low PCT of 0.82. If the valuation of emissions reduction in the PCT were similar to the valuation of emission reductions in the STRC, microturbines would have a PCT approaching 1.10 without any additional incentives. For microturbines fueled by on-site biogas to be a viable alternative to the participant will require either significant incentives or a modification in the valuation of GHG savings under the REC.¹⁹

¹⁹ The IC engine 500 kW is also modeled as a system associated with the initiation of methane capture. A higher valuation of the greenhouse gas reduction associated with this system in the PCT (going to the participant) would lead to a substantially higher PCT. A higher PCT should be associated with a higher likelihood of system implementation.

Table 5-11: Statewide Summary of Commercial Sector Societal TRC Results for 2016 and PCT Results for 2010, No Incentives

Technology	System Size (kW)	PG&E		SCE		SDG&E		Statewide Equalized		Statewide Elec. Sales Wgtd.	
		TRC - 2016	PCT - 2010	TRC - 2016	PCT - 2010	TRC - 2016	PCT - 2010	TRC - 2016	PCT - 2010	TRC - 2016	PCT - 2010
Wind Turbine											
1 MW nonresidential/government	1,000	1.70	1.63	1.73	1.57	1.72	1.36	1.72	1.52	1.72	1.58
Fuel Cell - Electric Only											
Natural gas	1,200	1.01	0.95	1.02	0.93	1.04	0.82	1.02	0.90	1.01	0.93
On-site biogas	1,200	1.00	1.00	1.01	0.99	1.03	0.89	1.01	0.96	1.00	0.98
Directed biogas	1,200	1.04	0.92	1.05	0.91	1.07	0.82	1.05	0.88	1.04	0.91
Fuel Cell - CHP (i.e., w/waste heat recovery)											
Natural gas powered	1,200	1.14	1.02	1.15	1.00	1.18	0.86	1.16	0.96	1.15	0.99
On-site biogas	1,200	1.18	1.12	1.19	1.10	1.22	0.97	1.20	1.06	1.19	1.09
Directed biogas	1,200	1.19	0.98	1.19	0.95	1.22	0.84	1.20	0.93	1.19	0.95
Gas Turbine - CHP											
Natural gas powered (1000 kW)	1,000	0.87	0.89	0.88	0.88	0.91	0.75	0.89	0.84	0.88	0.87
On-site biogas (1000 kW)	1,000	0.92	1.06	0.93	1.05	0.95	0.91	0.93	1.01	0.93	1.04
Directed biogas (1000 kW)	1,000	0.95	0.81	0.96	0.80	0.98	0.71	0.96	0.77	0.96	0.80
Natural gas powered (3500 kW)	3,500	1.09	1.07	1.10	1.05	1.13	0.88	1.11	1.00	1.10	1.04
On-site biogas (3500 kW)	3,500	1.22	1.40	1.23	1.38	1.26	1.17	1.24	1.32	1.23	1.37
Directed biogas (3500 kW)	3,500	1.16	0.95	1.17	0.94	1.20	0.81	1.18	0.90	1.17	0.93
Microturbine – CHP											
Natural gas powered	200	1.05	0.98	1.07	0.98	1.10	0.84	1.07	0.93	1.06	0.97
On-site biogas	200	1.52	0.82	1.52	0.83	1.54	0.75	1.53	0.80	1.52	0.82
Directed biogas	200	1.14	0.87	1.15	0.87	1.18	0.77	1.16	0.84	1.15	0.86
IC Engine - CHP											
Natural gas powered (500 kW)	500	1.21	1.18	1.23	1.18	1.27	0.99	1.23	1.11	1.22	1.16
On-site biogas (500 kW)	500	2.39	1.06	2.40	1.07	2.43	0.94	2.40	1.03	2.39	1.05
Directed biogas (500 kW)	500	1.29	1.02	1.30	1.02	1.34	0.89	1.31	0.98	1.30	1.01
Natural gas powered (1500 kW)	1,500	1.29	1.24	1.30	1.24	1.34	1.03	1.31	1.17	1.30	1.22
On-site biogas (1500 kW)	1,500	1.70	1.81	1.72	1.82	1.77	1.54	1.73	1.72	1.72	1.79
Directed biogas (1500 kW)	1,500	1.37	1.05	1.39	1.06	1.43	0.92	1.39	1.01	1.38	1.04
Organic Rankine Cycle											
	500	1.71	1.22	1.73	1.21	1.78	1.01	1.74	1.15	1.73	1.19
Storage											
Med storage	25	0.60	0.46	0.58	0.45	0.57	0.42	0.58	0.44	0.59	0.45
Larger storage	1,000	0.68	0.51	0.66	0.50	0.62	0.47	0.65	0.49	0.66	0.50

5.4 Program Administrator Cost Test Results

Table 5-12 lists the PA test results for DG systems evaluated by utility and at the statewide level for 2010 and 2016. The 2010 results are presented using the current SGIP program rebates. If a technology was not eligible to receive a rebate under the 2010 SGIP program, it was modeled as ineligible for a rebate. Technologies that are ineligible for rebates have a zero PA test value. In 2010, gas turbines, microturbines, IC engines, and ORC are ineligible for SGIP rebates. In 2011 all technologies evaluated in the SGIPce model are modeled to receive a SGIP rebate.

The results presented in Table 5-12 show that all evaluated DG technologies other than storage pass the PA cost-effectiveness test. The high PA test values reflect the large avoided cost benefits associated with the reduction in central plant electricity due to the installation of the DG technologies. PA test costs are relatively small for commercial customers. The PA test costs include the administrative costs, the incentives, and the increase in utility gas, if any, to fuel the DG technologies. For commercial customers, the SGIPce model evaluated the cost-effectiveness of DG technologies assuming that commercial customers purchase their gas on the wholesale market. Commercial customers who install DG technologies are assumed to not increase their consumption of utility natural gas. The high avoided electricity cost benefits coupled with the low PA costs leads to all technologies other than storage passing the PA test.

Table 5-12: Statewide Summary of Commercial Sector PA Test Results for 2010 and 2016

Technology	System Size (kW)	PG&E		SCE		SDG&E		Statewide Equalized		Statewide Elec. Sales Wgtd.	
		PA TEST - 2010	PA TEST - 2016	PA TEST - 2010	PA TEST - 2016	PA TEST - 2010	PA TEST - 2016	PA TEST - 2010	PA TEST - 2016	PA TEST - 2010	PA TEST - 2016
Wind Turbine											
1 MW nonresidential/government	1,000	1.33	1.66	1.38	1.72	1.34	1.68	1.35	1.69	1.35	1.69
Fuel Cell - Electric Only											
Natural gas	1,200	3.25	4.05	3.31	4.14	3.38	4.21	3.31	4.13	3.29	4.11
On-site biogas	1,200	1.83	2.27	1.85	2.32	1.90	2.37	1.86	2.32	1.84	2.30
Directed biogas	1,200	1.84	2.29	1.86	2.33	1.91	2.38	1.87	2.33	1.85	2.32
Fuel Cell - CHP (i.e., w/waste heat recovery)											
Natural gas powered	1,200	3.25	4.05	3.31	4.14	3.38	4.21	3.31	4.13	3.29	4.11
On-site biogas	1,200	1.83	2.27	1.85	2.32	1.90	2.37	1.86	2.32	1.84	2.30
Directed biogas	1,200	1.95	2.42	1.86	2.33	1.91	2.38	1.91	2.38	1.90	2.38
Gas Turbine - CHP											
Natural gas powered (1000 kW)	1,000	0.00	10.68	0.00	11.16	0.00	11.11	0.00	10.98	0.00	10.94
On-site biogas (1000 kW)	1,000	0.00	6.66	0.00	6.94	0.00	6.93	0.00	6.85	0.00	6.81
Directed biogas (1000 kW)	1,000	0.00	6.87	0.00	7.10	0.00	7.16	0.00	7.04	0.00	7.00
Natural gas powered (3500 kW)	3,500	0.00	35.26	0.00	39.83	0.00	36.28	0.00	37.13	0.00	37.42
On-site biogas (3500 kW)	3,500	0.00	22.30	0.00	24.91	0.00	22.98	0.00	23.40	0.00	23.54
Directed biogas (3500 kW)	3,500	0.00	24.81	0.00	27.11	0.00	25.65	0.00	25.86	0.00	25.93
Microturbine – CHP											
Natural gas powered	200	0.00	11.16	0.00	11.66	0.00	11.63	0.00	11.48	0.00	11.43
On-site biogas	200	0.00	6.96	0.00	7.25	0.00	7.26	0.00	7.16	0.00	7.12
Directed biogas	200	0.00	7.18	0.00	7.42	0.00	7.50	0.00	7.37	0.00	7.32
IC Engine - CHP											
Natural gas powered (500 kW)	500	0.00	14.34	0.00	15.12	0.00	14.93	0.00	14.80	0.00	14.75
On-site biogas (500 kW)	500	0.00	8.78	0.00	9.22	0.00	9.15	0.00	9.05	0.00	9.02
Directed biogas (500 kW)	500	0.00	9.13	0.00	9.49	0.00	9.53	0.00	9.38	0.00	9.33
Natural gas powered (1500 kW)	1,500	0.00	20.04	0.00	21.51	0.00	20.82	0.00	20.79	0.00	20.78
On-site biogas (1500 kW)	1,500	0.00	12.40	0.00	13.21	0.00	12.89	0.00	12.83	0.00	12.81
Directed biogas (1500 kW)	1,500	0.00	13.10	0.00	13.77	0.00	13.65	0.00	13.51	0.00	13.46
Organic Rankine Cycle	500	0.00	9.10	0.00	9.55	0.00	9.52	0.00	9.39	0.00	9.35
Storage											
Med storage	25	0.47	0.55	0.47	0.55	0.49	0.58	0.48	0.56	0.47	0.56
Larger storage	1,000	0.37	0.44	0.38	0.45	0.38	0.45	0.38	0.45	0.38	0.44

Appendix A

Examined DG Technologies

A.1 Introduction

The technical foundation of the cost-effectiveness model is a set of technology-specific workbooks on the different distributed generation (DG) technologies investigated in this study. The workbooks represent compiled performance and cost data from a variety of sources, including the CPUC's Self-Generation Incentive Program (SGIP). Secondary sources of information come from the combined heat and power industry, as well as academic institutions, national labs, federal or state energy programs, or other energy research organizations. This appendix explains the methods used for estimating and forecasting costs. It also identifies the sources, assumptions, and results for each individual DG technology. DG technologies examined in the study include fuel cells, small gas turbines; internal combustion (IC) engines, microturbines, wind energy systems; organic rankine cycle systems; and storage batteries.

The appendix begins with a discussion of learning curves and how learning curves are used to project future capital costs of DG technologies. Following the discussion on learning curves, we present a discussion on biogas collection and processing costs. A number of DG combustion technologies can be powered by natural gas or by biogas derived from anaerobic digestion processes (e.g., dairy digesters, landfill gas collection systems, and wastewater treatment facilities). Biogas collection and processing costs are treated collectively as they cut across the different DG technologies.

A.1.1 Treatment of DG Learning Curves and Costs

The overarching concept behind learning curves is that companies operating in competitive markets can “learn” to manufacture goods more efficiently as they gain experience in the manufacturing and production of the goods. As a company sells more units of some technology or product “X,” it learns ways to decrease production costs. These lower production costs can be transferred to the consumer as lower prices. The level of learning is quantified by a reduction in costs while the metric for gained experience is the total number of units sold.

For energy applications, the learning curve is typically depicted by plotting the cost of the technology against the cumulative capacity of the technology sold over the same time period. Figure A-1 shows a learning curve for the cost of PV modules between 1976 and 1992.

Figure A-1: Learning Curve for PV Modules, 1976-1992

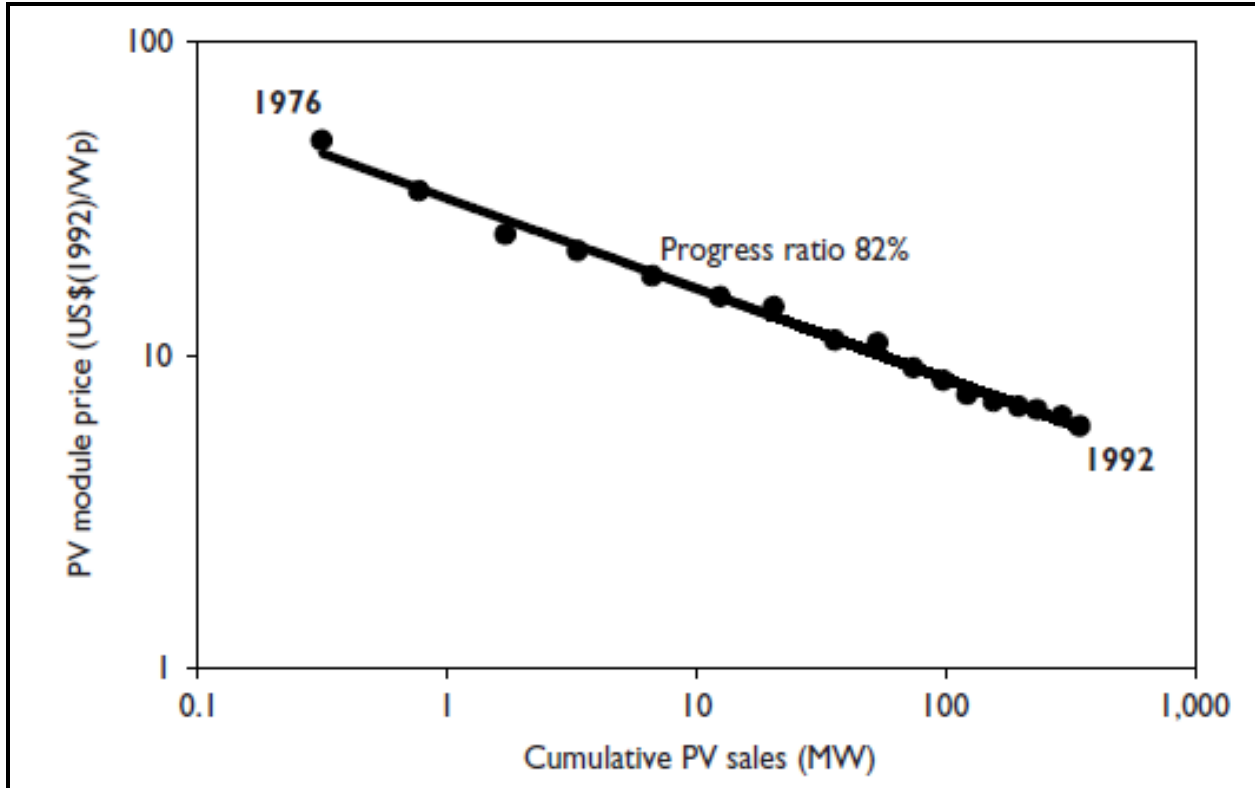

Source: *Experience Curves for Energy Technology Policy*, International Energy Agency, 2000

All things being equal, the cost per watt produced of a PV module in 1992 dollars decreased with the increase in cumulative capacity sold (logarithmic scale). The trend line that connects the data is known as the “learning curve” or “experience curve”. The curve can be defined by the following mathematical expression:

$$Price\ at\ year\ t = P_0 * X^{-E}$$

P_0 is a constant equal to the price at one unit of cumulative production. The variable X represents the cumulative capacity sold in year t , and the exponent E is the experience parameter, which represents the “learning rate” of the market. The learning rate is most commonly presented as a “Progress Ratio” (PR) defined as follows:

$$PR = 2^{-E}$$

In the case of PV modules produced between 1976 and 1992, the progress ratio is 82%. This implies that the price of the technology is reduced to 0.82 of its previous level after a doubling of cumulative capacity sold. One would expect more mature technologies to have higher progress ratios (the upper limit is 100%) until the technology reaches a point where learning by experience no longer drives cost reductions. On the other hand, emerging technologies tend to have lower progress ratios and show larger cost reductions as more is learned about ways to improve production or lower material costs.

Learning curves, because they are based on the demonstrated capability of companies to improve manufacturing or production processes, represent a powerful way to predict future costs of technologies. In this study, learning curves and progress ratios are used to predict future capital costs for the different DG technologies up through 2020. While this approach does not take into account all the economic factors affecting capital costs (such as commodity prices), the method has been implemented successfully in the past in energy policy applications.

Itron used a series of data sources on DG technology production volumes and prices including historical SGIP cost data, literature surveys, and DG technology industry interviews. Based on the collected information, learning curve models were developed for each examined DG technology. The developed learning curves were then used to forecast possible future costs of the technologies out through 2020.

Figure A-2 is a summary of the estimated installed costs of the examined DG technologies from 2008 through 2020 based on learning curve projections.

Figure A-2: Summary of Learning Curve DG Technology Cost Projections

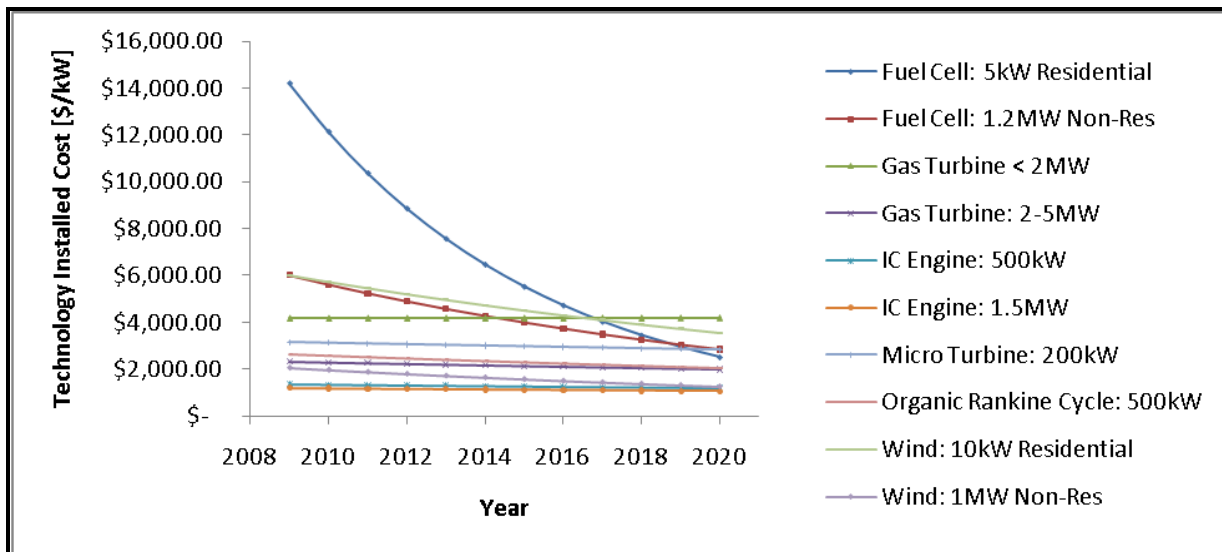

It is clear that some emerging technologies like fuel cells have very aggressive learning curves. This rapid learning is assumed to occur because new technologies with low volume production can see “faster” benefits from lessons associated with improvements in production. Conversely, well established technologies such as IC engines and gas turbines have rather flat or even “negative” learning curves. The specific approach and assumptions used to collect cost, capacity, and performance data changes for each of the examined DG technologies are covered later in this appendix.

A.1.2 Treatment of Biogas Collection and Processing Costs

“Biogas” refers to the methane-rich gas that is produced from the naturally-occurring anaerobic biological breakdown (or digestion) of organic materials such as manure or food processing wastes. Biogas is a mixture of methane, carbon dioxide, water and a variety of other trace compounds. Depending on the source of the biogas and its associated methane content, biogas represents a renewable fuel source with an energy content of approximately half that of natural gas.¹ Biogas has been used as a fuel resource for hundreds of years but saw increased use for electricity generation purposes in the United States in the mid-1980s following passage of the Public Utility Regulatory Policies Act (PURPA) of 1978.² Common sources of biogas include landfills, wastewater treatment facilities, food processing plants, and livestock operations (e.g., dairies, swine operations, etc.). Since the startup of the SGIP in 2001, over 50 SGIP projects have been installed that use biogas as a fuel source.

Natural gas prices implicitly reflect costs associated with collecting natural gas from underground reservoirs and processing it to remove water and other contaminants. Similarly, biogas must be collected and processed before use in DG technologies. Unlike natural gas resources, it is necessary to also estimate the costs associated with the anaerobic processes that biologically convert the solid or liquid biomass resources to biogas. Biogas conversion costs are not considered as project capital costs for landfills and wastewater treatment facilities in this study. In the case of both landfills and wastewater treatment facilities, the biological conversion systems are already in place and do not represent costs that must be borne by the biogas-to-energy project.³ Conversely, biogas conversion systems (e.g., digesters) are not already in place at dairies or food processing facilities. Consequently, we incorporated the costs of biogas gas collection and conversion systems as part of the overall biogas to energy project costs for energy applications at livestock (dairies and swine operations) and food processing facilities.

¹ Simons, G. and Z. Zhang, “Distributed Generation from Biogas in California,” Interconnecting Distributed Generation Conference, March 21, 2001

² Lusk, P. “Methane Recovery from Animal Manures: The Current Opportunities Casebook,” for the National Renewable Energy Laboratory, NREL/SR-580-25145, September 1998

³ While the biogas conversion systems are considered to be in place, biogas treatment costs must still be considered for both landfills and wastewater treatment facilities if the biogas is to be used as a fuel.

A biogas model was developed to estimate the added costs associated with converting, capturing, and cleaning biogas at the source (e.g., dairy, landfill, wastewater treatment facility, etc.). To develop cost estimates, we developed estimates of the flow of biogas needed for the project. The expected input fuel gas flow rate of each technology was estimated as follows:

$$kWh_{in} = \frac{\text{Rated kW} * 8760 \frac{\text{hrs}}{\text{year}} * CF}{\eta_{\text{electrical}}}$$

The energy required to fuel the system for one year (expressed above as kWh_{in}) is the product of the rated capacity of the system, the numbers of hours in the year (8760) and the average annual capacity factor (CF) of the technology divided by its electrical efficiency (η_{electrical}). Capacity factors and electrical efficiency values were based on metered values obtained from biogas-powered SGIP facilities and then compared to other reported test data in order to provide sound engineering estimates of representative biogas flows for each technology.

$$SCFD_{\text{Bio Gas In}} = \frac{kWh_{in} * 3412 \frac{BTU}{kWh}}{600 \frac{BTU_{\text{Bio Gas}}}{SCF} * 365 \frac{\text{Days}}{\text{year}}}$$

The daily flow of biogas (SCFD_{BioGasIn}) required for each technology is the product of the required energy input (kWh_{in}) converted to Btu divided by the energy content of the biogas and the number of days in the year. For this study, we assumed biogas had an average higher heating value of 600 Btu per standard cubic foot. Once daily biogas flow rates were established for each technology, capital and operations/maintenance costs were calculated for the appropriate anaerobic digestion, gas capture, and cleanup processes. As a result, biogas conversion, collection, and processing costs could be provided on a capital and O&M basis or provided in a unit price per energy (i.e., \$ per million Btu), similar to natural gas.

Estimating Biogas Conversion and Collection Costs

As indicated earlier, biogas conversion system costs were developed only for biogas systems used at dairies or food processing facilities. Three different types of anaerobic digesters were considered when estimating the costs of biogas conversion and capture processes for these applications: covered lagoons, complete mix digesters, and plug flow digesters. The operating principle behind all three digesters is the same: methane-rich biogas gas is generated and captured as a result of bacteria digesting the solid or liquid biomass resources. However, the three systems differ in the types of biomass resources they can digest and their associated costs.

A covered lagoon digester consists of a storage lagoon with a cover. Liquid biomass wastes (e.g., dairy manure or food processing wastes) are diverted to the storage lagoon. The cover

traps the gas produced during the biological breakdown of the mostly liquid waste. The generated biogas is extracted from inside the cover and then cleaned up or flared depending on the intended use of the biogas. Covered lagoon digesters are a common approach for dairy biogas operations. In general, covered lagoon digesters tend to be less capital-intensive than other digester systems and are best suited for warmer climates.

Complete mix digesters are similar to the digestion systems used at wastewater treatment plants. They rely on a mixture of the biomass waste seeded with bacteria in a heated tank that can be located above or below ground to break down the biomass waste. These systems are suitable for larger biomass waste volumes. However, the waste must be continuously mixed to prevent the entrained solids from sinking to the bottom. Complete mix digesters can be expensive to build and maintain.

Plug flow digesters consist of a long, rectangular container with an airtight expandable cover. New biomass material added to the tank at one end pushes older material to the opposite end and anaerobic digestion releases biogas as the material flows through the digester. Plug flow digesters require some heat but otherwise minimal maintenance.

For simplicity, the only biogas source considered in the biogas model was animal manure. On average, each animal (assumed for simplicity to be a cow) was expected to produce 65 standard cubic feet of biogas per day (SCFD) regardless of digester type.⁴ The total amount of gas associated with different numbers of animals, and in turn total capital costs per number of animals, can then be calculated based on this assumption and using cost models developed by the Environmental Protection Agency (EPA) AgStar Program.⁵ Figure A-3 summarizes the capital cost of each type of digester system as a function of number of animals. Note that the only system that appears to scale up properly for large number of animals may be the covered lagoon. In California the average dairy has 8,000-12,000 animals. The resulting estimated capital costs for plug flow or complete mix digesters for dairies larger than 5,000 animals appear high. As a result, we used the more conservative capital cost estimates associated with covered lagoon digesters for larger-scale applications (e.g., gas turbines or larger IC engines).

⁴ Personal communication with Zhiqin Zhang, California Energy Commission, 2007.

⁵ The EPA AgStar cost models can be found at EPA's website:
http://www.epa.gov/agstar/documents/digester_cost_fs.pdf

Figure A-3: Digester Cost Based on Number of Animals

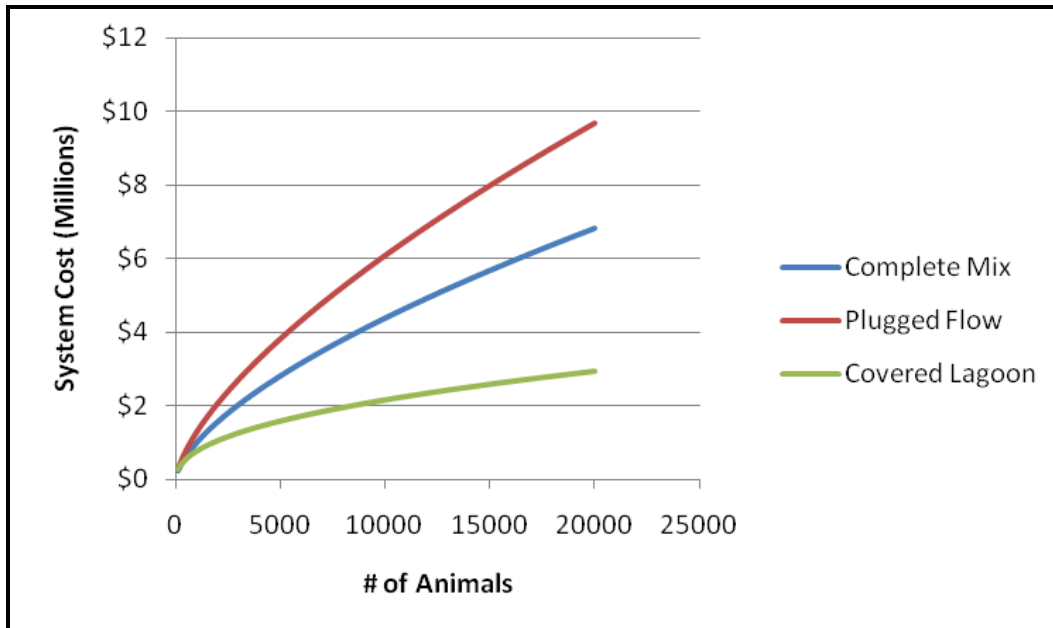

A linear regression model developed in AgStar program was used to develop the gas capture capital cost data.⁶ The model was developed using capital costs from 40 dairy farms for systems designed in 2003-2009.

A.1.3 Biogas Cleanup Costs

After the methane-rich gas has been collected from the digestion process, it is typically processed before use in most electricity generation systems. Depending on the electricity generation system, biogas must be processed to remove excess moisture and reduce concentrations of hydrogen sulfide (H₂S), or in some cases siloxanes contained in the biogas stream.

Moisture should be removed to avoid corrosion, especially for high speed engines such as microturbines. If the moisture in the air precipitates into small droplets, they can erode the blades that are spinning at a very high speed. This will lead to rapid loss of performance and unplanned overhauls.

H₂S is a byproduct from the bacterial breakdown of organic matter in the absence of oxygen. H₂S is highly corrosive and produces accelerated wear of engine valves, and plates out on or corrodes cylinder liners and turbine blades. In addition, H₂S can poison fuel cells and catalysts used for controlling NO_x emissions.

⁶ http://www.epa.gov/agstar/documents/digester_cost_fs.pdf

Siloxane is a contaminant in biogas resulting from breakdown of personal hygiene, health and industrial products found in landfills and wastewater treatment facilities. Oxidation of siloxanes during combustion causes formation of silicates that can deposit on internal combustion engine pistons and turbine blades. Failure to prevent build up of these silicate deposits has been shown to lead to component failure and expensive engine overhauls. Like H₂S, silicates also can act to foul or poison catalyst surfaces and fuel cell components.

Figure A-4 outlines typical steps involved in cleaning biogas. In this example, the biogas is used to fuel a microturbine and therefore there is an extra step to pressurize the outgoing gas.

Figure A-4: Example Flow Diagram for Bio Gas Cleanup System (Microturbine)

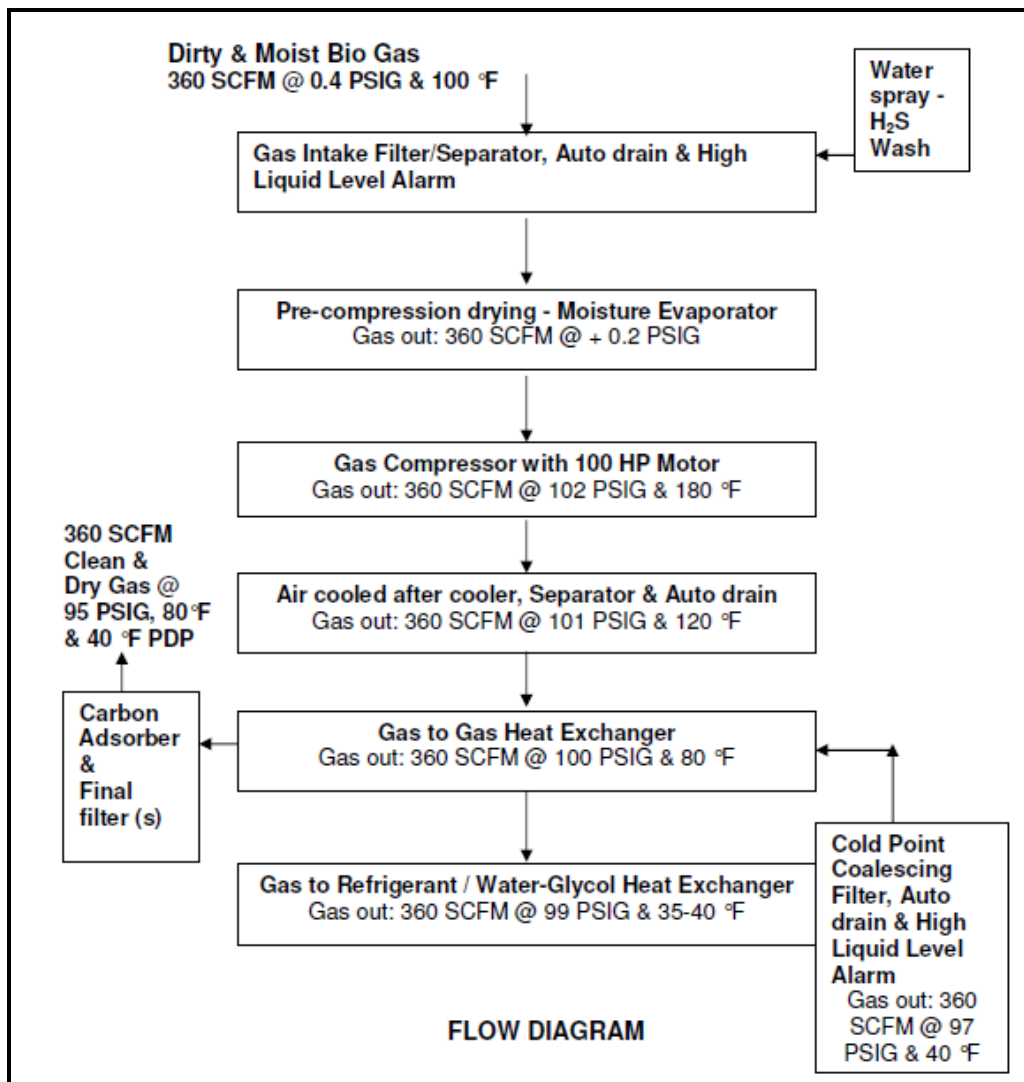

Source: Flow diagram and cost estimates obtained from Pioneer Air Quality Systems, personal communication with Itron, May 28,2010.

Several critical assumptions were made in sizing the sample biogas clean up system and estimating costs. For example, the system sizing assumes that the incoming biogas has a flowrate of 360 standard cubic feet per minute (SCFM) and contains 500 PPMV H₂S (a rough approximation for landfill gas). The cleanup requirements bring the H₂S content down to 50 PPMV for reciprocating engines and 5 PPMV for turbines. Cleanup requirements for fuel cells were treated separately due to the high purity requirements of the gas.

Capital costs for gas cleanup systems are based on quotations received from a vendor (Pioneer Air Systems) and levelized according to gas flow rate as described above.

Figure A-5: Biogas Cleanup Costs as a Function of Flow Rate

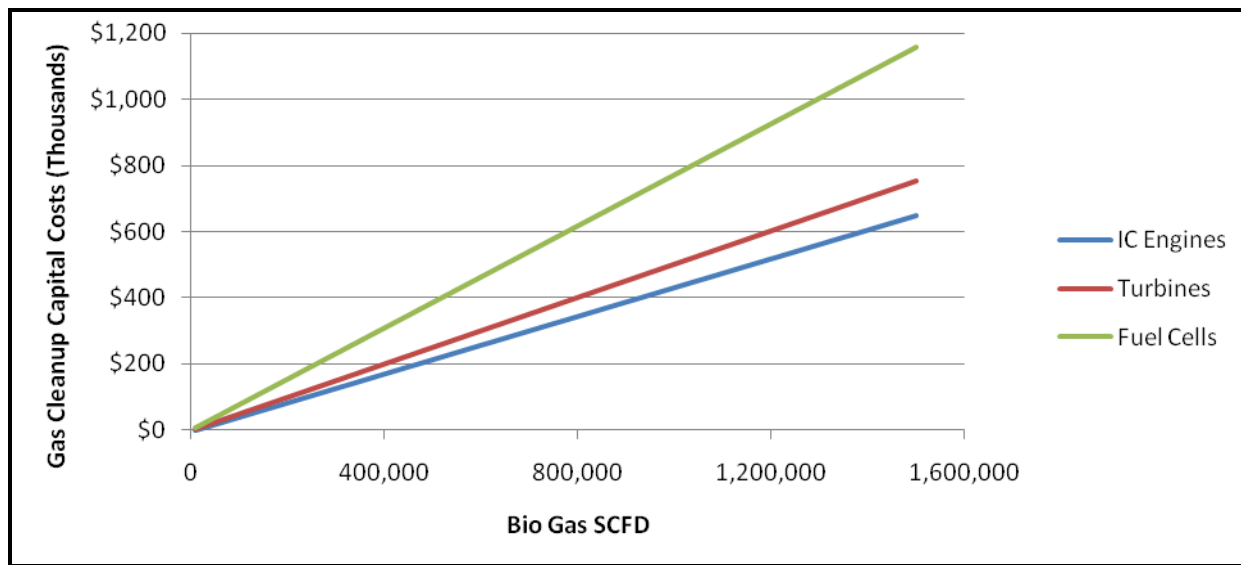

As expected, Figure A-5 shows that DG technologies with the strictest cleanup requirements have the highest capital gas cleanup costs. It is also clear that as the system size increases (larger flow rate), the costs start to become prohibitive.

Operating and maintenance costs for the cleanup systems were treated separately. O&M costs typically include filter replacements, regular oil changes, and maintenance to the cleanup systems, electricity operating costs, and labor costs.

To maintain consistency with the gas clean up system capital costs, O&M costs were also taken directly from the Pioneer Air Systems quotes.⁷ O&M costs included filter replacements and regular maintenance (including oil changes and compressor maintenance for the turbines).

⁷ However, capital costs and O&M costs developed for this example were checked against capital costs and O&M cost estimates from other sources, including EPA’s AgStar Program and the CEC’s Dairy Biogas Program.

Electricity costs are based on the 20kW that the cleanup system is expected to draw, combined with the capacity factor of the system and levelized based on the actual gas consumption of the technology. Electricity costs were assumed to be \$0.15/kWh.

$$Electricity\ Cost\ per\ Year = 20kW * 8760 \frac{hrs}{year} * CF * 0.15 \frac{\$}{kWh} * \frac{Actual\ SCFD}{Rated\ SCFD}$$

In order to associate the capital and O&M costs for gas capture and gas cleanup to the individual DG technologies, it was necessary to estimate the annual energy requirements. Table A-1 lists the technology inputs for each individual technology studied in this report using biogas as a fuel resource.

Table A-1: Technology Inputs Used to Calculate Required Biogas Flow Rate

Technology	TECHNOLOGY INPUTS			
	Efficiency	Capacity Factor	Yearly Energy Input Required [kWh]	BG Flow Rate [SCFD] (3412 Btu/kWh, 600 Btu/SCF)
Gas Turbine 1MW	24%	80%	28,839,506	449,317
Gas Turbine 3.5MW	32%	80%	77,866,667	1,213,156
Fuel Cell 1.2 MW	46%	91%	20,795,478	323,992
Micro Turbine 200 kW	24%	80%	5,840,000	90,987
ICE 500 kW	33%	80%	10,781,538	167,975
ICE 1.5 MW	33%	80%	32,344,615	503,926

The efficiency and capacity factors are obtained from various sources in the literature and checked against metered values from the SGIP. The yearly energy input is estimated based on the efficiency and capacity factor for each technology. The required daily flow rate is then calculated based on an assumed biogas LHV of 600 BTU/SCF.

Table A-2 lists estimates of the capital and O&M costs associated with capturing biogas for the different DG technologies examined in the study. Table A-3 provides estimated of the total biogas cleanup costs for each of the DG technologies. The cleanup costs are technology-specific and based on biogas flow rates determined in Table A-2.

Table A-2: Estimated Capital and O&M Costs of Biogas Capture for DG Technologies

Technology	# Animals (65 ft ³ /day/cow)	GAS CAPTURING COSTS				Average Gas Capture Capital Cost	Yearly Gas Capture O&M Cost
		Complete Mix	Plug Flow	Covered Lagoon			
Gas Turbine 1MW	6,913	\$ 3,472,868	\$ 4,758,654	\$ 1,829,230	\$ 3,353,584	\$219,359	
Gas Turbine 3.5MW	18,664	\$ 6,544,829	\$ 9,239,215	\$ 2,834,652	\$ 6,206,232	\$592,269	
Fuel Cell 1.2 MW	4,984	\$ 2,818,903	\$ 3,824,859	\$ 1,583,573	\$ 2,742,445	\$158,174	
Micro Turbine 200 kW	1,400	\$ 1,253,682	\$ 1,637,480	\$ 904,486	\$ 1,265,216	\$ 44,420	
ICE 500 kW	2,584	\$ 1,853,815	\$ 2,466,283	\$ 1,185,294	\$ 1,835,131	\$ 82,006	
ICE 1.5 MW	7,753	\$ 3,736,540	\$ 5,137,596	\$ 1,924,139	\$ 3,599,425	\$246,019	

Table A-3: Estimated Total Biogas Clean Up Costs by DG Technology

Technology	CLEANUP COSTS
	Yearly Gas Cleanup O&M Costs
Gas Turbine 1MW	\$ 62,862
Gas Turbine 3.5MW	\$ 93,840
Fuel Cell 1.2 MW	\$ 74,946
Micro Turbine 200 kW	\$ 48,330
ICE 500 kW	\$ 51,812
ICE 1.5 MW	\$ 65,437

Based on the estimated capital and O&M costs, levelized costs were developed that could be compared to estimates developed by other sources. Table A-4 lists the levelized capital and O&M costs used in the cost-effectiveness model.

Table A-4: Estimated Levelized Biogas Costs

Technology	LEVELIZED CAPITAL COST /kW				LEVELIZED O&M
	Complete Mix	Plug Flow	Covered Lagoon	Average System	/kWh
Gas Turbine 1MW	\$ 3,698.22	\$ 4,984.01	\$ 2,054.58	\$ 3,578.94	\$ 0.04027
Gas Turbine 3.5MW	\$ 2,043.79	\$ 2,813.62	\$ 983.74	\$ 1,947.05	\$ 0.02797
Fuel Cell 1.2 MW	\$ 2,557.41	\$ 3,395.71	\$ 1,527.97	\$ 2,493.70	\$ 0.02437
Micro Turbine 200 kW	\$ 6,496.58	\$ 8,415.57	\$ 4,750.60	\$ 6,554.25	\$ 0.06617
ICE 500 kW	\$ 3,853.44	\$ 5,078.38	\$ 2,516.40	\$ 3,816.07	\$ 0.03819
ICE 1.5 MW	\$ 2,636.84	\$ 3,570.88	\$ 1,428.57	\$ 2,545.43	\$ 0.02963

A.1.4 Conclusions

California has a dairy animal population of 1.4 million animals, representing the largest dairy population of any state in the country.⁸ These animals generate over 30 million tons of manure annually, which could be used as a renewable energy resource if found to be environmentally acceptable and cost-effective. Farms of at least 500 cows account for over 88% of California dairy operations and farms having 1,000 to 5,000 cows are the most common.⁹ Our cost analysis shows that microturbines and IC engines smaller than 1.5 MW in capacity represent the most likely scale of DG system based on the number of animals commonly found on dairy farms, and the associated cost of anaerobic digester systems. Based on current regulations and requirements, digester costs were applied only to dairy or food processing applications that were not otherwise required to install systems to capture and flare biogas. Within the SGIPce model, this equated to dairy digester capital costs being applied to on-site biogas applications of 500 kW in capacity or smaller.

⁸ U.S. EPA, Region 9, Animal Waste web site; <http://www.epa.gov/region9/animalwaste/california.html>

⁹ Economic Research Service, USDA, “Profits, Costs, and the Changing Structure of Dairy Farming,” ERR47, <http://www.ers.usda.gov/publications/err47/err47b.pdf>

A.2 Fuel Cells

A.2.1 Technology Summary

Fuel cells are electrochemical devices that generate electricity by means of a chemical oxidation/reduction reaction.

Figure A-6: Basic Fuel Cell Schematic

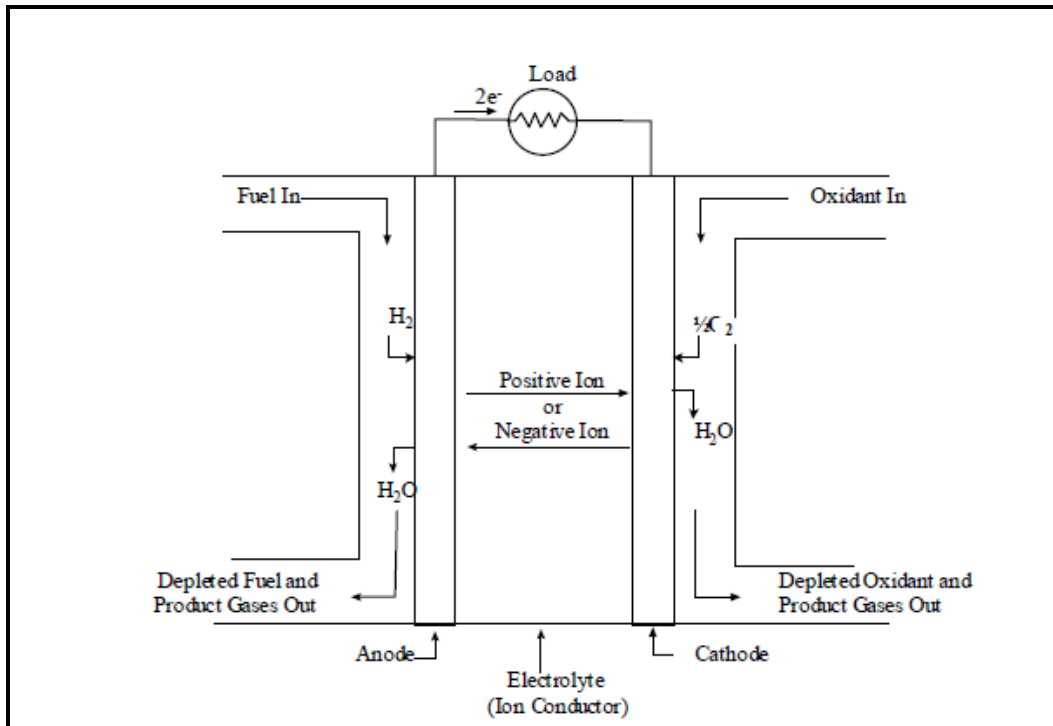

Source: *Fuel Cell Handbook 6th Edition*

The operation of most hydrogen fuel cells is represented in Figure A-6. Hydrogen (or a hydrogen-carrying fuel) is continuously fed at the anode while an oxygen carrier (typically air) is continuously supplied at the cathode. With the help of a catalyst, a chemical reaction takes place that generates an electron charge and transfers a hydrogen ion across the electrolyte. Each individual fuel cell generates a small voltage. Consequently, multiple cells need to be connected with a bipolar plate and combined into a “stack” to produce the desired power output.

There are several types of fuel cells in production today and can be broken down by the type of electrolyte material.

Polymer Electrolyte Membrane (PEM) fuel cells operate at low temperatures (60-80 °C) and provide low-to-medium power output. The combination of low temperature and low power production generally makes them impractical for CHP operations. However, they can respond to

load changes more quickly than other fuel cell designs. As a result, PEM fuel cells have seen moderate penetration in hydrogen vehicle applications. They are also starting to appear in residential DG applications as costs decrease.

PEMs require a very pure fuel supply at the anode to prevent poisoning and fouling of the catalyst (they are particularly intolerant of CO). Ideally the cell should be supplied with pure hydrogen and oxygen. However, most DG applications use hydrogen reformed from natural gas at the anode and ambient air at the cathode; both leading to lower efficiencies and shorter stack life. Two of the largest vendors in the DG market are Ballard Power Systems and ClearEdge Power.

Phosphoric Acid Fuel Cells (PAFC) operate in the same way as PEMs except that the ion carrying electrolyte is 100% concentrated phosphoric acid. PAFC's operate at slightly higher temperatures than PEMs (150–220 °C) making them more suitable for CHP applications. CO poisoning at the anode can be an issue as it is with PEMs. Currently, UTC power is one of the most prominent PAFC vendors in the United States.

Molten Carbonate Fuel Cells (MCFC) operate at high temperatures (600-700 °C) and, therefore, do not require expensive catalysts to reform natural gas (like platinum in PEMs and PAFCs), making them more suitable to CHP applications. Unlike the low temperature cells previously discussed, MCFCs are tolerant of CO and require CO₂ at the cathode to operate, making them a better potential fit for biogas applications. The chemical reaction is also very different and involves a carbonate ion traveling across molten salt instead of a hydrogen ion. FuelCell Energy is currently one of the most prominent MCFC vendors.

Solid Oxide Fuel Cells (SOFC) are also high temperature fuel cells (600–1000 °C), making them ideal for CHP. In this case an oxygen ion crosses a solid metal oxide electrolyte. Bloom Energy is one vendor of SOFCs and is aggressively pursuing SOFC sales in the United States.

For the purposes of this report, PEM fuel cells appear to be the fuel cell technology most viable at the residential scale (5 kW rated capacity) and was used in the model for residential fuel cell applications. A combination of all other technologies (PAFC, MCFC, SOFC) was used for the large non-residential scale (i.e., at a 1,200 kW rated capacity) applications that included waste heat recovery. The Bloom Energy SOFC acted as the basis for the electrical only non-residential fuel cell applications.¹⁰

¹⁰ Bloom Energy's fuel cell was selected to represent the electric only fuel cell application as they had the vast majority of applications into the SGIP using this configuration.

A.2.2 Past SGIP Applications

From 2001 through 2009, there were 25 fuel cell projects deployed through the SGIP representing approximately 15 MW of generating capacity. Table A-5 is a summary of the number of fuel cell projects, capacity, and reported installed costs (\$/Watt) broken out by IOU service territory and fuel type (i.e., natural gas or biogas).¹¹

Table A-5: Summary of SGIP Fuel Cell Characteristics as of 12/31/2009

IOU	Natural Gas				Biogas			
	Number	Capacity	Avg	Cost	Number	Capacity	Avg	Cost
	n	MW	(kW)	(\$/Watt)	n	MW	(kW)	(\$/Watt)
PG&E	10	5.5	550	NA	1	0.6	600	NA
SCE	2	0.5	250	NA	3	1.65	550	NA
SDG&E	4	2.25	563	NA	0	0	0	NA
SCG	2	1.5	750	NA	3	2.7	900	NA
Subtotal:	18	9.75	528	\$7.83	7	4.95	513	\$7.71

NA: not available

A.2.3 Technology Operating Characteristics

Electrical Efficiency

The following table summarizes the electrical efficiency values reported by major fuel cell manufacturers for non-residential fuel cells.

Table A-6: Non-Residential Fuel Cell Efficiencies from Vendor Specifications

Model	Nominal Electrical Efficiency (LHV)
UTC 400	42%
Bloom Box	50%
FCE 1500	47%
Un-Weighted Average	46%

¹¹ In accordance with SGIP requirements, applicants receiving incentives were required to provide estimates of total installed project costs to the SGIP Program Administrators. The costs presented here reflect only the cost data reported by the applicants to the PAs.

From Table A-6, the average fuel cell electrical efficiency based on the lower heating value of the fuel is 46%. However, it should be noted that these values are based on a new cell operating under ideal conditions. Over time, performance will degrade and the stacks will consume more fuel to generate the same amount of power; causing a reduction in electrical efficiencies.

Figure A-7: Performance of UTC 400 over Time

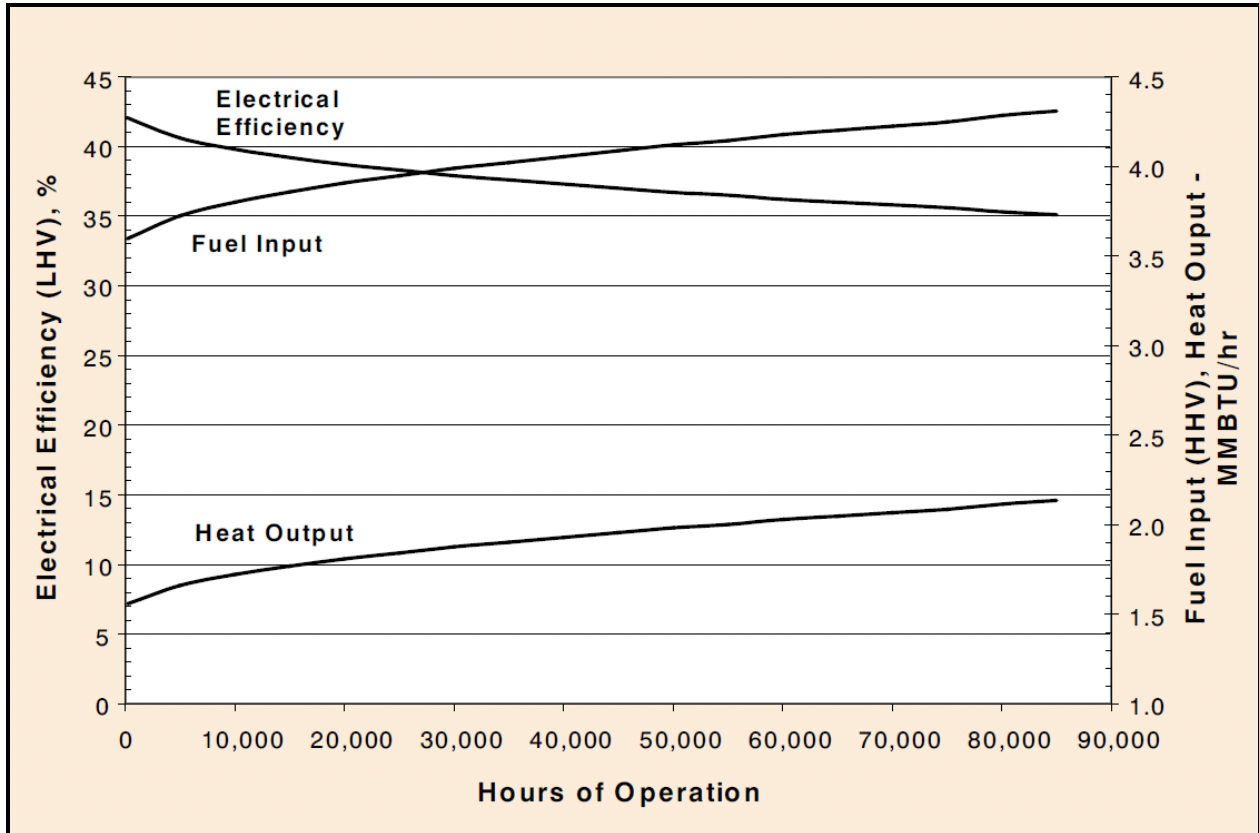

Source: UTC Power Model 400 Product Data and Applications Guide.

Figure A-7 shows the performance of the UTC 400 (PAFC) starting from ideal conditions and progressing to the end of stack life. The electrical efficiency drops from 42% to 35%, meaning that at the end of its life the stack requires more fuel to generate the same amount of electricity.

For residential PEM systems, the efficiencies are lower, around 30-35% (as per the EPA’s catalog of CHP technologies).¹² The degradation profiles are also different; PEM stacks (specifically the thin membrane) tend to fail completely as opposed to slowly degrade over time.

¹² U.S. Environmental Protection Agency Combined Heat and Power Partnership – Catalog of CHP Technologies.

Table A-7 is a summary of the 2008 and 2009 electric conversion efficiencies for fuel cell systems installed under the SGIP. The average electrical efficiencies of 39.3% and 40.6% compare well to the UTC specification sheet numbers but are significantly lower than the electrical efficiencies shown for Bloom or FCE. Several points need to be remembered when comparing the SGIP measured efficiencies against values taken from specification sheets: 1) the SGIP values represent averages of fuel cell technologies from several generations while the specifications represent a single generation of technology; 2) the SGIP values represent annual averages while the vendor specification sheets may represent a single, maximum efficiency level; and 3) the measured SGIP electrical conversion efficiency values are limited in their sample size (i.e., five data points).

Table A-7: Measured Fuel Cell Electric Conversion Efficiencies (SGIP: 2008-09)

Program Year	Metered Systems	Electric Efficiency
	n	(%, LHV)
2008	8	40.6 ± 4.1
2009	5	39.3 ± 2.0

Source: Itron, 2008 and 2009 SGIP Impact Evaluation Reports.

Waste Heat Recovery

Due to their relatively high operating temperatures, fuel cells are good candidates for waste heat recovery. Few fuel cells were installed in the early program years of the SGIP and there is limited waste heat recovery information. However, Table A-8 provides a summary of the measured waste heat recovery from fuel cells operating in the SGIP during calendar year 2009. The values represent the observed useful waste heat recovery in units of thousands of Btu per kilowatt-hour of generated electricity (kBtu/kWh). The CPUC has indicated that in a reconfigured SGIP, CHP systems must achieve at least 60% system efficiency. Assuming that fuel cells will operate at 46% electrical efficiency, this will require them to have a least a 14% thermal efficiency. Consequently, for the purposes of this study, fuel cells were assumed to have the ability to recover 1.84 kBtu of useful waste heat per kW of generated electricity.

Table A-8: Waste Heat Recovery from SGIP Fuel Cells (2009)

Year	Metered Sites	Waste Heat Recovery (kBtu/kWh)			
	n	min	max	mean	Capacity Weighted Average
2009	7	0.01	1.98	0.81	0.78

Air Pollution Emissions

The following table summarizes air pollution emissions data taken from different fuel cell manufacturer’s specifications. The non-residential emissions values were taken from fuel cells different in size than the nominal 1200 kW capacity used in the model. However, the emissions are on a per-MWh basis and were presumed to scale appropriately. Note that CHP fuel cells offset boiler fuel (assumed to be natural gas for this study). Waste heat recovery values were therefore used to estimate offset boiler emissions.

Table A-9: Air Pollution Emissions Data

Pollutant	Non-Residential 1200 kW	Residential 5 kW
CO ₂ (lb/MWh)	863	1,360
NO _x (lb/MWh)	0.03	0.06
PM10 (lb/MWh)	0.00002	0.00002

Ramp Rates and Generator Profiles

Ramp rate refers to the ability of a generator to respond to changes in load. For example, a CHP system may be sized to meet a significant amount of on-site thermal load. However, depending on the price of retail rate electricity at peak hours, the CHP facility system operator may ramp up or down the amount of electricity being generated (with commensurate changes in thermal production) to optimize the cost-effectiveness of the system. While some low temperature fuel cells such as the UTC 400 (PAFC) or PEM have the ability to follow changes in load up to 10kW per sec (as per the UTC 400 specification sheet), a typical fuel cell installation is intended to operate at constant load.

As part of the impact evaluation work conducted on the SGIP, metered data was collected on a number of the fuel cell systems deployed under the program. In a number of instances, 15-minute electricity generation data was collected over the course of a full year (i.e., 8760 hours). To assess the load following aspects of the different DG technologies, hourly load profiles across the 2008 calendar year were developed. Figure A-8 and Figure A-9 are representative generation profiles for fuel cell systems deployed under the SGIP in the SDG&E and PG&E service territories, respectively.

Figure A-8: Representative Fuel Cell Generation Profile (SDG&E)

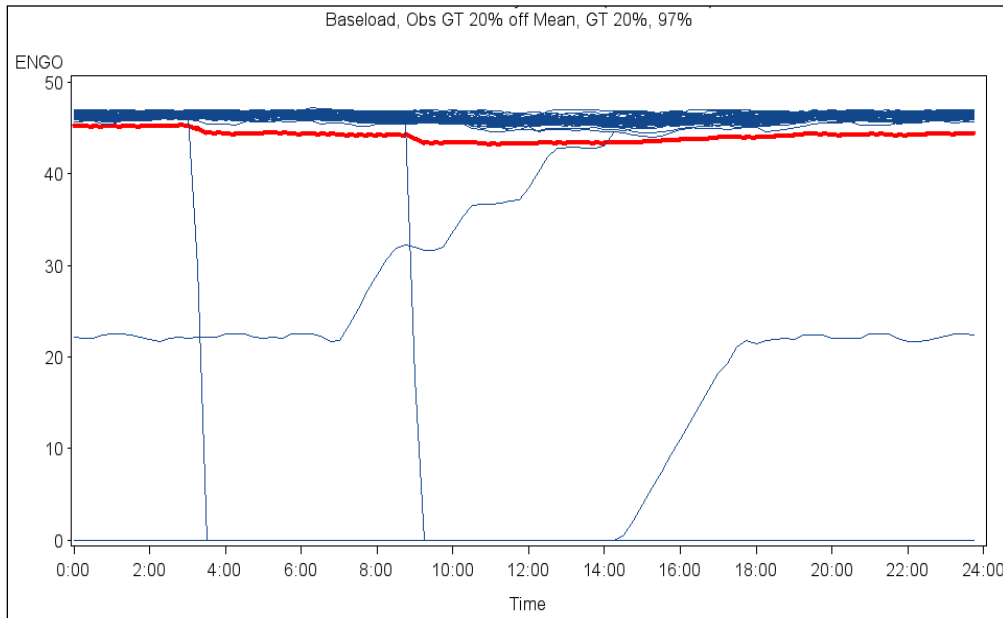
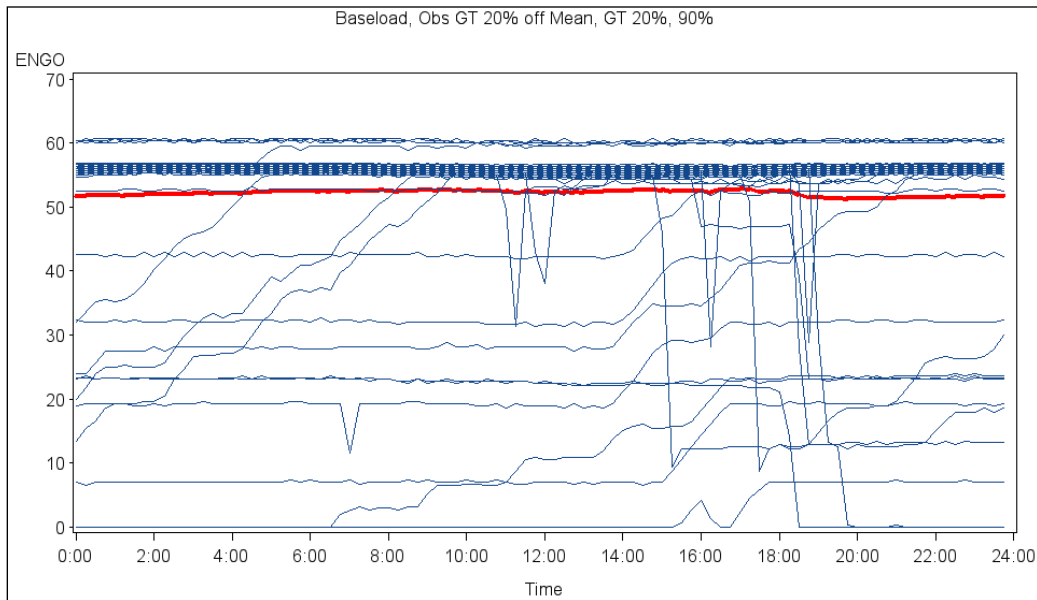

Figure A-9: Representative Fuel Cell Generation Profile (PG&E)



In general, the figures show the Electrical Net Generation Output (ENGO) plotted against the hour of the day over the course of the year. The blue lines represent the hour-by-hour generation profiles for any one day of the year. The red line represents the hourly generation profile averaged over the entire set of metered hourly data available for the 8760 hours of the year. After a review of the generator profiles, generation was classified as “baseload” or “non-baseload” depending on 20% or greater deviations from the mean occurring at least 20% of the

time. Generation where 80% of the hourly generation profiles fell within 20% of the mean hourly value was deemed to be baseload generation. Review showed that all of the fuel cell projects deployed under the SGIP for which there was metered data matched the definition of baseload generation. As a result, for the purposes of this report, all DG fuel cells for non-residential stationary applications were considered base load technologies.

A.2.4 Current Technology Capital Costs

The most recent (2009) fuel cell capital costs were obtained from a combination of financial reports, SGIP data, and phone interviews. The information is summarized in Table A-10 as installed cost per kW.

Table A-10: Fuel Cell Capital Costs

System	Installed Cost (\$/kW)	Source of Information
Residential PEM (ClearEdge)	\$14,200	ClearEdge
Non-Residential PAFC (UTC)	\$7,500	UTC
Non-Residential MCFC (FCE)	\$3,950	FCE
Non-Residential Electric Only SOFC (Bloom)	\$9,000	SGIP data

The ClearEdge system was considered representative of all residential fuel cell installations and the \$14,200/kW installed cost was used in the model as the capital cost for the residential application. For the non-residential fuel cell application with waste heat (i.e., CHP fuel cell) application, a weighted average of PAFC and MCFC technologies was used. This resulted in an average non-residential CHP fuel cell levelized installed cost of \$6,009/kW with an additional \$144/kW for waste heat recovery.¹³ The Bloom Energy SOFC stack is the most widely available non-residential electrical-only stack, and therefore an installed cost of \$9,000/kW was used for the fuel cell, electric-only application.¹⁴

¹³ Waste heat recovery costs were assumed to represent an additional 2.4% of the system cost.

¹⁴ Installed costs for the Bloom systems were taken from application data supplied by Bloom Energy to the CPUC and SGIP Program Administrators. The median cost for the Bloom Energy systems was \$9,000/kW. A complete listing of the submitted cost data can be found at: <https://energycenter.org/index.php/incentive-programs/self-generation-incentive-program/sgip-documents/sgip-documents>

Capital Cost Elements

The major components contributing to capital costs in the fuel cell stack are:

- Membrane
- Catalyst
- Bipolar Plate
- Manufacturing/R&D Costs

The fractional cost of each component varies between the different fuel cell technologies (e.g., the catalyst is a much larger cost component of a PEM stack than a MCFC stack).

Figure A-10 shows the approximate breakdown of installed costs for a SOFC. However, individual installations vary from site to site and this breakdown often varies due to site-specific considerations. For this reason, it was not possible to develop a detailed breakdown of installed costs that could be used in the model.

Figure A-10: Approximate SOFC Cost Structure

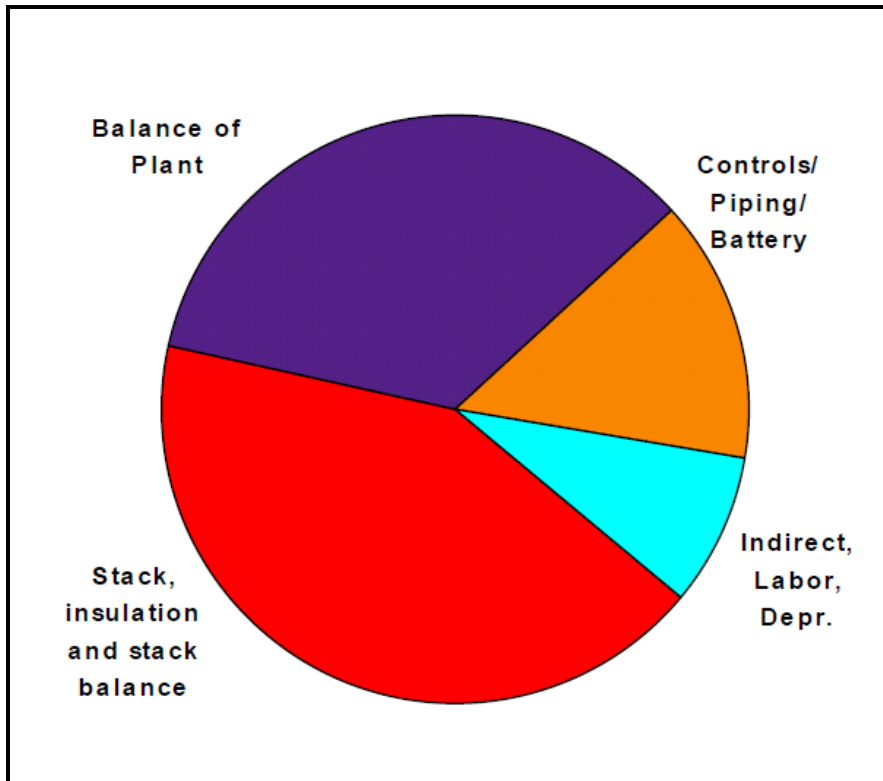

Source: EG&G Technical Services Inc, Science Applications International Corporation – *Fuel Cell Handbook, 6th Edition*, November 2002.

Costs Reflected in SGIP

Installed costs of fuel cells deployed under the SGIP are provided in Table A-5. On average, the installed capital costs, at approximately \$7,830/kW for natural gas-powered fuel cells and \$7,710/kW for biogas-powered fuel cells, compares well with the capital cost of \$7,500/kW shown for non-residential PAFC in Table A-10.

Conclusions on Capital Costs

The most current capital costs were collected and averaged to generate the starting point for the fuel cell cost-effectiveness model. These costs should reflect total initial installed costs to the consumer before any rebates are applied. The residential cost based on ClearEdge’s price is \$14,200/kW. The average non-residential cost is \$6,009/kW.¹⁵ The installed cost of a non-residential electrical only stack is \$9,000/kW.

A.2.5 Technology Operating and Maintenance (O&M) Costs

Like other DG technologies, fuel cells have on-going O&M costs associated with maintenance, repair, consumption of chemicals, electricity for operation, etc. We contacted various fuel cell manufacturers to obtain estimates of on-going O&M costs. The O&M costs shown in Table A-11 are based on manufacturer service plans that cover all the maintenance costs for the fuel cell.¹⁶ The costs are levelized by the expected annual energy production of the system. The expected annual energy production is based on the electrical efficiency (discussed previously in Table A-6) and the capacity factor. The capacity factor used for this model is 91% based on a study by Chevron Energy Solutions at a San Ramon facility operating a UTC 400.¹⁷ Also note that these costs do not include the expected salary for a facilities engineer who would monitor the facility’s day-to-day operations.

Table A-11: Estimated Fuel Cell O&M Costs

Fuel Cell System	Levelized O&M Cost
Residential	\$0.022/kWh
Non-Residential	\$0.03/kWh

¹⁵ Note that this represents only the system; an additional cost of \$144/kW must be added to take into account waste heat recovery.

¹⁶ This O&M cost includes replacement of the stack at close to five-year intervals.

¹⁷ Climate Change Fuel Cell Program, ChevronTexaco Fuel Cell Project Final Report, September 2004.

Fuel Costs

The costs of fuel (natural gas and biogas) are not specific to the fuel cell model. However, the amount of fuel consumed is based on the rated capacity of the system divided by the electrical efficiency (based on lower heating values of the fuel).

A.2.6 Estimating Future Capital Costs

Two distinct learning curves were generated for fuel cells: one for residential systems and a separate curve for non-residential systems.

Residential Fuel Cells

Due to the infancy of the residential fuel cell technology, limited information is available on historical system costs. Because of this limited information, a progress ratio of 80% from the academic literature was used instead.¹⁸ The cumulative installed capacity information was derived from annual industry survey data. Figure A-11 shows the observed growth rate for residential fuel cells from 2000 through 2009. The estimated growth rate is 62%.

Figure A-11: Growth Data for Residential Fuel Cells

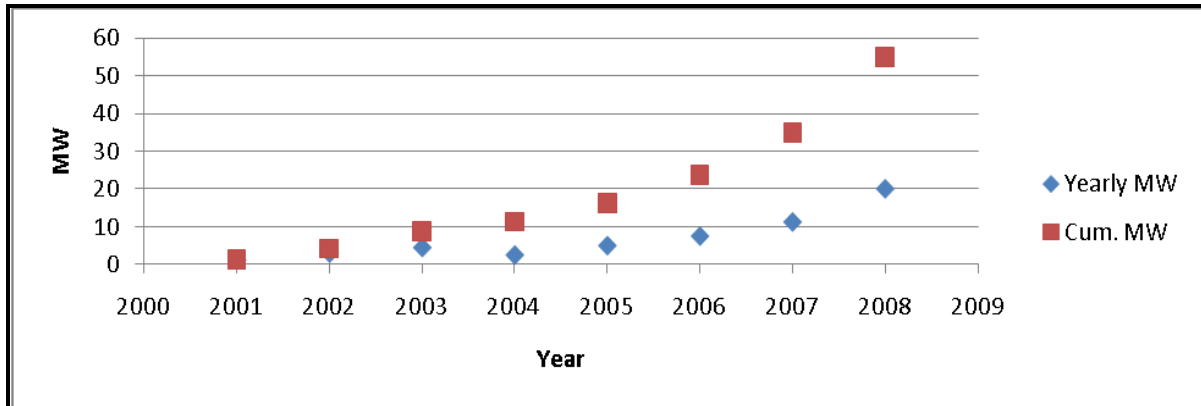

Non-Residential Fuel Cells

For non-residential systems, the primary sources of cost data were annual financial reports from Fuel Cell Energy.¹⁹

¹⁸ I. Staffell, and R.J. Green, “Estimating future prices for stationary fuel cells with empirically derived experience curves,” *International Journal of Hydrogen Energy* 34 (2009), 5617-5628, June 2009.

¹⁹ FuelCell Energy 2009 Annual Report.

Figure A-12 shows the levelized cost of production as a function of cumulative capacity sold from Fuel Cell Energy’s Annual Financial Reports. Using the methods described in Section A.1.1 the calculated progress ratio was estimated at 82%.

Figure A-12: Learning Curve for Fuel Cell Energy Systems

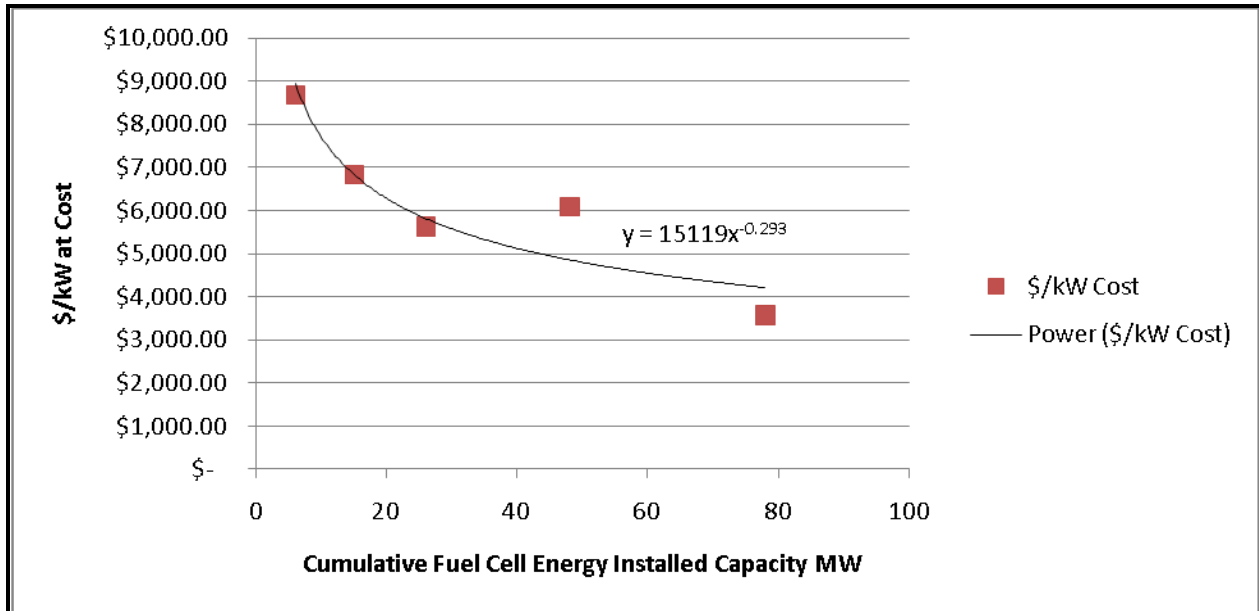

The cumulative installed capacity data from Fuel Cell Energy’s Annual Financial Reports is not indicative of the total industry-wide installed capacity. Survey data were used to find the industry-wide actual installed capacity.

Figure A-13 shows historical yearly and cumulative installed MW data for non-residential fuel cell systems. These data, combined and phased with Fuel Cell Energy’s costs, were used to develop the learning curve for non-residential fuel cell systems. This learning rate was assumed to be valid for electrical only non-residential fuel cell systems as well.

Figure A-13: Growth Data for Non-Residential Fuel Cell Systems

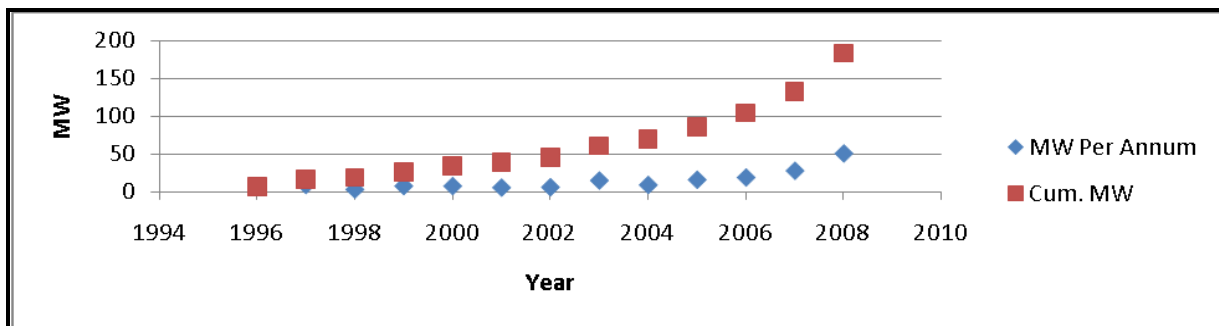

A.2.7 Impacts of Learning Curve on Capital Costs

The learning curves show technology cost decreases due to learning-by-doing experience, which improves performance and enables manufacturing to become more streamlined and efficient. The results are summarized below in Table A-12 and Figure A-14.

Table A-12: Results of Learning Curve Data on Fuel Cell Costs

System Type	2010 Cost	Progress Ratio	Growth Rate	2020 Cost
Residential	\$12,137 / kW	80%	62%	\$2,525 / kW
Non-Residential	\$5,613 / kW	82%	26%	\$2,838 / kW
Non-Residential Electrical Only	\$8,406 / kW	82%	26%	\$4,251 / kW

Figure A-14: Effect of Learning Curves on Fuel Cell Capital Costs

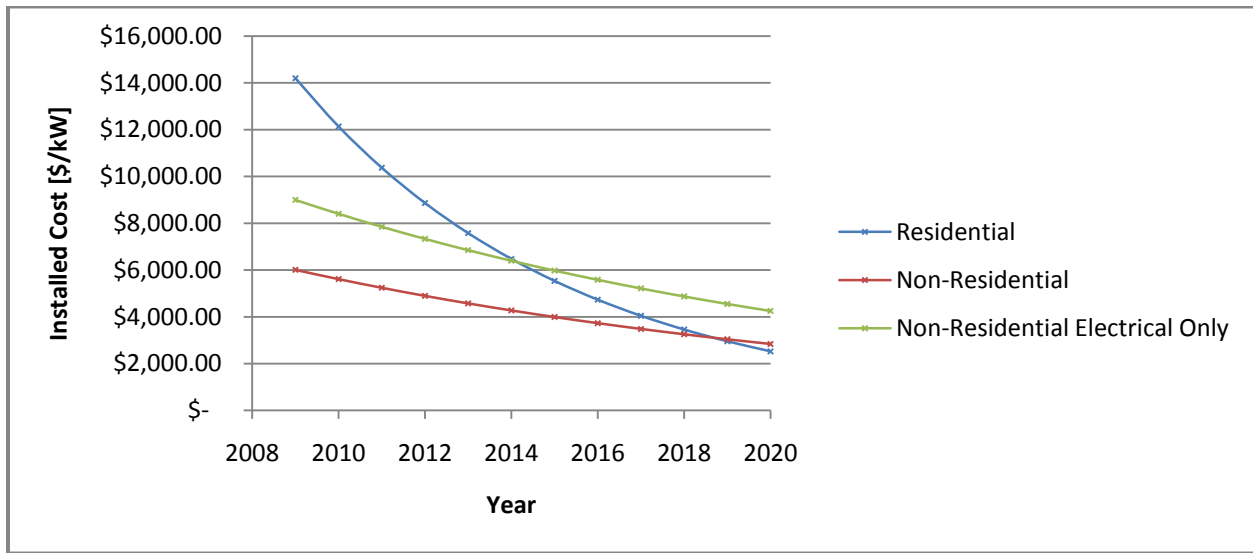

Overall, learning curves indicate seven-fold reduction in capital costs of residential fuel cells over the next decade; from current costs of \$14,000/kW to approximately \$2,500/kW by 2020. The more mature non-residential fuel cell systems have an expected three-fold reduction in capital costs over the same time frame.

A.3 Small Gas Turbines (<5MW)

A.3.1 Technology Summary

Gas turbines operate on the principle of the Brayton Cycle, a thermodynamic cycle where atmospheric air is compressed, heated, and expanded. Figure A-15 shows the basic configuration and components of a gas turbine system. The power produced by the expansion of the air in the turbine and consumed by the compressor is proportional to the absolute temperature of the gas passing through the device. A higher pressure and temperature ratio will result in a higher efficiency and specific power.

Figure A-15: Simple Schematic of a Gas Turbine System

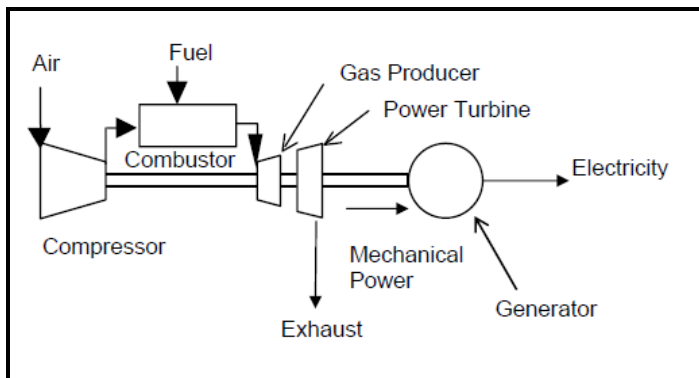

Source: US EPA, "Technology Characterization: Gas Turbines," *Catalog of CHP Technologies*, 2008.

Sizes can range anywhere from 500 kW to 250 MW systems. However, for the purposes of this study, we focused on gas turbines smaller than 5 MW. These smaller DG gas turbine systems can be used in power-only generation, or in combined heat and power (CHP) applications. Exhaust output of small gas turbines range from 800 °F to 1100 °F. Because of the high thermal output, the exhaust can be used directly for many uses, including production of steam or hot water; in absorption cooling, or additional power generation (i.e., through a bottoming cycle). Gas turbines can run on natural gas, synthetic gas, landfill gas or fuel oils, and have a typical time to overhaul ranging from 25,000 to 50,000 hours.

There are many different manufacturers of gas turbines and most design systems much larger than 5 MW. Two companies which manufacture the most widely used turbines in the SGIP program are Kawasaki and Solar Turbines.²⁰ Representative sizes and web sites for these two manufacturers are listed in Table A-13 below.

Table A-13: List of Gas Turbine Manufacturers Commonly Represented in SGIP

Company	Gas Turbine Size (kW)	Website
Kawasaki Heavy Industries	1400-18000	http://www.khi.co.jp/
Solar Turbines	1000-10000	http://mysolar.cat.com/

Past SGIP Applications

The SGIP incentives for gas turbines are limited to a system size of 5 MW. The incentives are capped at 3 MW per site and are based upon a tiered incentive structure. Under the SGIP, 10 gas turbines were rebated between period of 2004 and 2008. These installations ranged from 750 kW to 4600 kW and were separated into two groups based on size; those equal to or under 2 MW, and those in the 2 to 5 MW size range. Table A-14 is a summary of the number of gas turbine projects, capacity, and reported installed costs²¹ (in \$/Watt) broken out by IOU service territory. Note that only natural gas is shown as a fuel type; gas turbine projects installed under the SGIP up through 2009 had not used renewable fuel.

Table A-14: Summary of SGIP Gas Turbine Characteristics as of 12/31/2009

IOU	Natural Gas			
	Number	Capacity	Avg	Cost
	n	MW	(kW)	(\$/Watt)
PG&E	4	127.2	230	\$7.59
SCE	0	0	0	NA
SDG&E	3	14.2	459	\$7.30
SCG	3	29.9	611	\$6.38
Subtotal:	10	171.3	325	\$7.19

²⁰ Other gas turbine manufacturers involved in the SGIP include Ingersoll-Rand and DTE.

²¹ In accordance with SGIP requirements, applicants receiving incentives were required to provide estimates of total installed project costs to the SGIP Program Administrators. The costs presented here reflect only the cost data reported by the applicants to the PAs.

A.3.2 Technology Operating Characteristics

Electrical Efficiency

Electrical conversion efficiency for a turbine is defined as the useful power output divided by the fuel consumption. The energy content of fuel can be calculated using lower heating value (LHV) or higher heating value (HHV). For natural gas, the higher heating value is greater than the lower heating value by about 11%.²² In turn, heat rate is often used in describing the efficiency of a generation system. Heat rate is expressed as the number of BTUs of heat required to produce a kilowatt-hour of energy. Operators of generating facilities can make reasonably accurate estimates of the amount of heat energy a given quantity of fuel produces. The following equation can be used to estimate the electrical efficiency of a generator:

$$\text{Electrical Efficiency } (\eta) = \frac{\text{Power Output (kWh)} * 3.412 \left(\frac{\text{kBtu}}{\text{kWh}}\right)}{\text{Fuel Consumed (kBtu)}}$$

When used with heat rate, the equation becomes:

$$\text{Electrical Efficiency } (\varepsilon) = \frac{3413 \left(\frac{\text{kBtu}}{\text{kWh}}\right)}{\text{Heat Rate } \left(\frac{\text{kBtu}}{\text{kWh}}\right)}$$

Heat rate of Kawasaki and Solar Turbine gas turbines can be found on their specification sheets, and is useful as representative heat rates for small gas turbines. For Kawasaki, the heat rates range from about 18,956 Btu/kWh for systems smaller than 1 MW; 14,217 Btu/kWh for 1,500kW systems, and 12,795 Btu/kWh for 4 MW systems. This is slightly higher than Solar Turbines, which advertises a heat rate around 14,000 Btu/kWh for 1.2 MW systems, and 8,862 Btu/kWh for 4.6 MW systems. Based on these heat rates, efficiencies of small gas turbines in the 1 to 4 MW size range should generally fall between 24% and 39% (LHV).

Ambient air temperature and altitude has a noticeable effect on the power output and the efficiency of gas turbines. Decreased airflow mass rate will result in a power decrease, while efficiency decreases because the compressor requires more power to compress air of higher temperature. It takes more work for the turbine to compress less dense higher-altitude air thus reducing the efficiency of the units. Figure A-16 and Figure A-17 from Solar Turbines and Kawasaki respectively, show the relationship between power output and heat rate versus air temperature.

²² Within this report, LHV is used in determining efficiency.

Figure A-16: Solar Turbines Saturn 20 Model, Available Power Graph

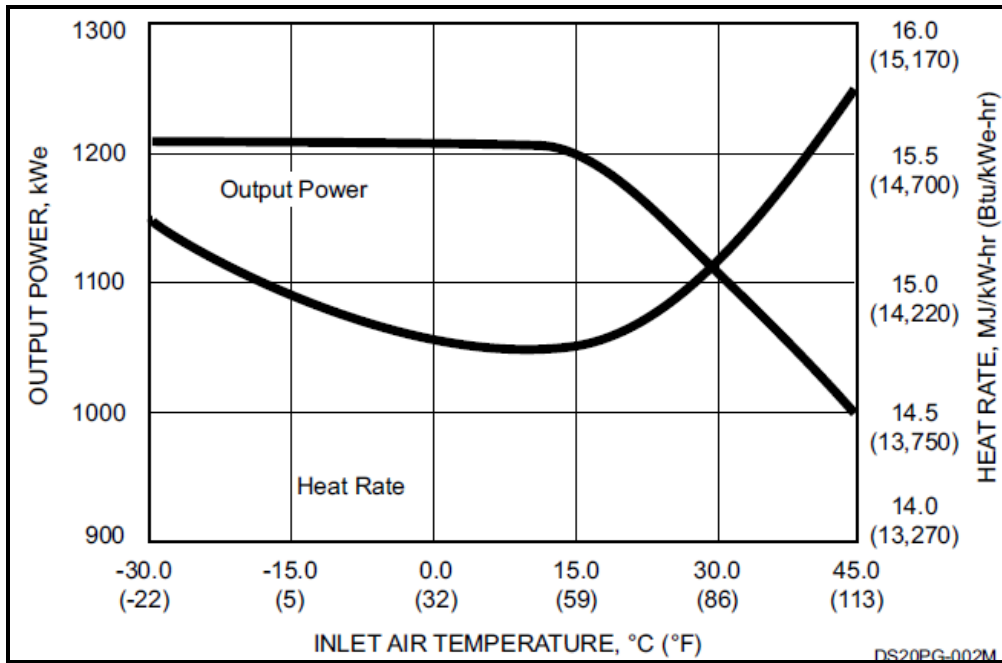

Source: Solar Turbines, “Saturn 20 Gas Turbine Generator Set Spec Sheet.”

Figure A-17: Kawasaki GPB15/30 Models, Available Power Graph

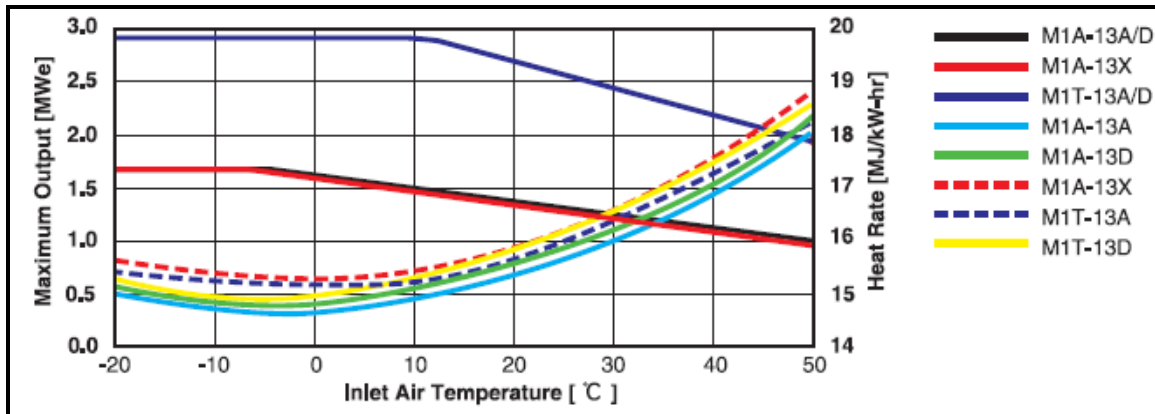

Source: Kawasaki, “Kawasaki Gas Turbine Generator Sets Spec Sheet.”

As the power graphs show, the maximum power output drops quite significantly around 60 °F, and at even lower temperatures for the Kawasaki models. Cooler temperatures (e.g., between 40-50 °F) can result in an increase in power up to 105% of ISO-rated power. However, ambient temperatures above 60 °F will result in a drop in power.²³

²³ US EPA, "Technology Characterization: Gas Turbines," *Catalog of CHP Technologies* (2008).

Table A-15 lists measured electrical efficiencies (LHV basis) for gas turbines operating in the SGIP during 2008 and 2009. In general, electrical efficiencies ranged from approximately 33% to 42% and closely match the specifications from manufacturers. For the purposes of this study, gas turbines smaller than 2 MW were assumed to have an electrical efficiency of 24% (LHV), whereas gas turbines in the 2 to 5 MW size range were assumed to have an electrical efficiency of 32% (LHV).

Table A-15: Electrical Efficiencies of Gas Turbines as Measured in the SGIP (2008-09)

Program Year	Metered Systems (n)	Electric Efficiency (%, LHV)
2008	6	42.3%
2009	4	32.6%

Degradation Factor

A report on Avoided Cost Estimates submitted to the Idaho Public Utilities Commission in 2002 reported degradation factor estimates of 1.75% for Gas Turbines.²⁴ Other studies have used degradation factors up to 2.5%. Figure A-18 estimates gas turbine degradation factor as a function of its operation hours.²⁵

Figure A-18: Degradation Factor versus Operation Hours

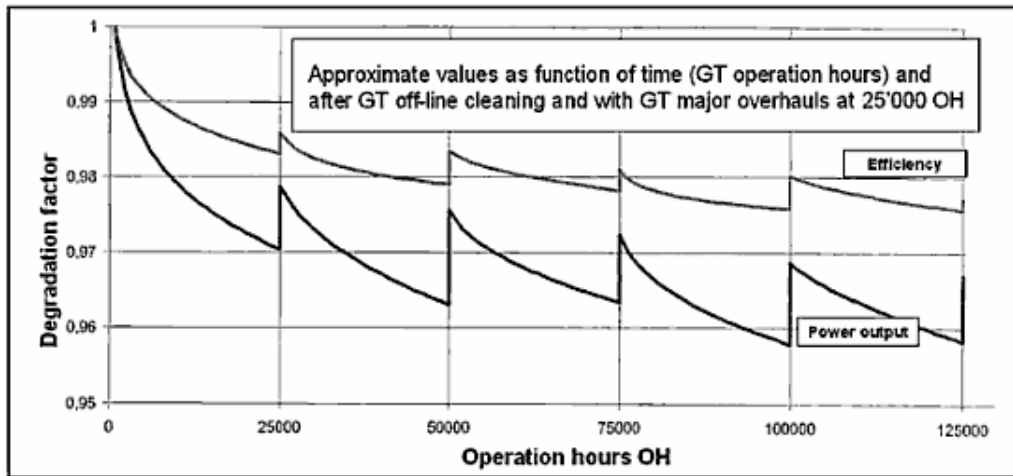

Source: *Combined-Cycle Gas & Steam Turbine Power Plants* (Tulsa, Okla.: PennWell, 2009)

²⁴ Jay K. Johnson, Idaho Public Utilities Commission, *Avoided Cost Estimate*, 2002.

²⁵ Rolf Kehlhofer, *Combined-Cycle Gas & Steam Turbine Power Plants*, Tulsa, Okla.: PennWell, 2009.

Net Capacity Factor

Capacity factor compares the plant's actual production over a given period of time with the amount of power the plant would have produced if it had run at full capacity for the same amount of time. Capacity factor is expressed by the following equation:

$$\text{Capacity Factor} = \frac{\text{Actual amount of power produced over time}}{\text{Power that would have been produced if turbine operated at maximum output 100\% of the time}}$$

The SGIP Impact Evaluation Reports from 2006-2008 reported an average annual capacity factor of approximately 75% for gas turbine technologies.

Waste Heat Recovery

Due to the small number of gas turbine applications under the SGIP, there is limited information on metered useful waste heat recovery. Table A-16 provides a summary of the measured useful waste heat recovery from gas turbines operating in the SGIP during calendar year 2009. The values represent the observed useful waste heat recovery in units of thousands of Btu per kilowatt-hour of generated electricity (kBtu/kWh). Using an average electrical efficiency for gas turbines of approximately 31% and the CPUC requirement of at least 60% overall efficiency, gas turbines were assumed to have the ability to recover 2.79 kBtu of useful waste heat per kWh of generated electricity for the purposes of this study,.

Table A-16: Useful Waste Heat Recovery from SGIP Gas Turbines (2009)

Year	Metered Sites	Waste Heat Recovery (kBtu/kWh)			
	n	min	max	mean	Capacity Weighted Average
2009	3	2.07	5.88	3.92	3.06

Air Pollution Emissions

Gas turbines are among the cleanest fossil-fueled power generation equipment available. However, turbine operating load will have a significant effect on emissions level of NOx, CO, and VOCs. Although maximum efficiency and optimum combustion is achieved at higher loads, NOx emissions are also higher. Lower loads will produce more incomplete combustion, resulting in higher emissions of CO and VOCs. The EPA compared emissions of typical gas

turbine systems in 2007.²⁶ Table A-17 shows average emissions levels for NO_x, CO, CO₂ and total carbon for both a 1 MW system and a 5 MW system.

Table A-17: Emissions for 1 MW and 5 MW Systems

Emissions Characteristics	System 1 (1,000 kW)	System 2 (5,000 kW)
NO _x (ppm)	42	15
NO _x (lb/MWh)	2.43	0.66
CO (ppmv)	20	25
CO (lb/MWh)	0.71	0.68
CO ₂ (lb/MWh)	1,877	1,440
Carbon (lb/MWh)	512	393
PM10 (lb/MWh)*	0.0625	0.0625

Source: Joseph J. Macack, "Evaluation of Gas Turbine Startup and Shutdown Emissions for New Source Permitting," from <http://www.environmental-expert.com/Files/6709/articles/5647/evaluationofpermitting.pdf>.

Kawasaki's Gas Turbine specification sheets show values for NO_x emissions at around 25 ppm at 15% O₂ for all their models ranging between 1MW to 5 MW. Solar Turbines Mercury 50, with a capacity of 5 MW, shows NO_x emissions at less than 9 ppm and CO at 20 ppm. As the numbers from these specification sheets are in compliance with the numbers from Table A-17, they provide a good representation of the emissions from gas turbines and were used in the cost-effectiveness model.

Ramp Rates and Generator Profiles

Ramping of gas turbine operation is used for bringing the system up into power from a cold start or for reacting to changes in demand. Gas turbines are ramped up slowly from a cold condition to avoid temperature strains in the casing and rotors that could cause damage. According to Solar Turbines, their gas turbines have an average ramp rate of 0.5% of nameplate power output per second.

²⁶ US EPA, "Technology Characterization: Gas Turbines," *Catalog of CHP Technologies*, 2008.

As part of the impact evaluation work conducted on the SGIP, metered data was collected on a number of the gas turbine systems deployed under the program. In a number of instances, 15-minute electricity generation data was collected over the course of a full year (i.e., 8760 hours). To assess the load following aspects of the different DG technologies, hourly load profiles across the 2008 calendar year were developed. Figure A-19 and Figure A-20 are representative gas turbine generation profiles for systems deployed under the SGIP in the SCG service territory. Figure A-19 is based on an occupancy application, such as that seen in hotels. Figure A-20 is based on a process application, such as that seen in a commercial manufacturing process).

Figure A-19: Representative Gas Turbine Generator Profile (SCG: Occupancy Application)

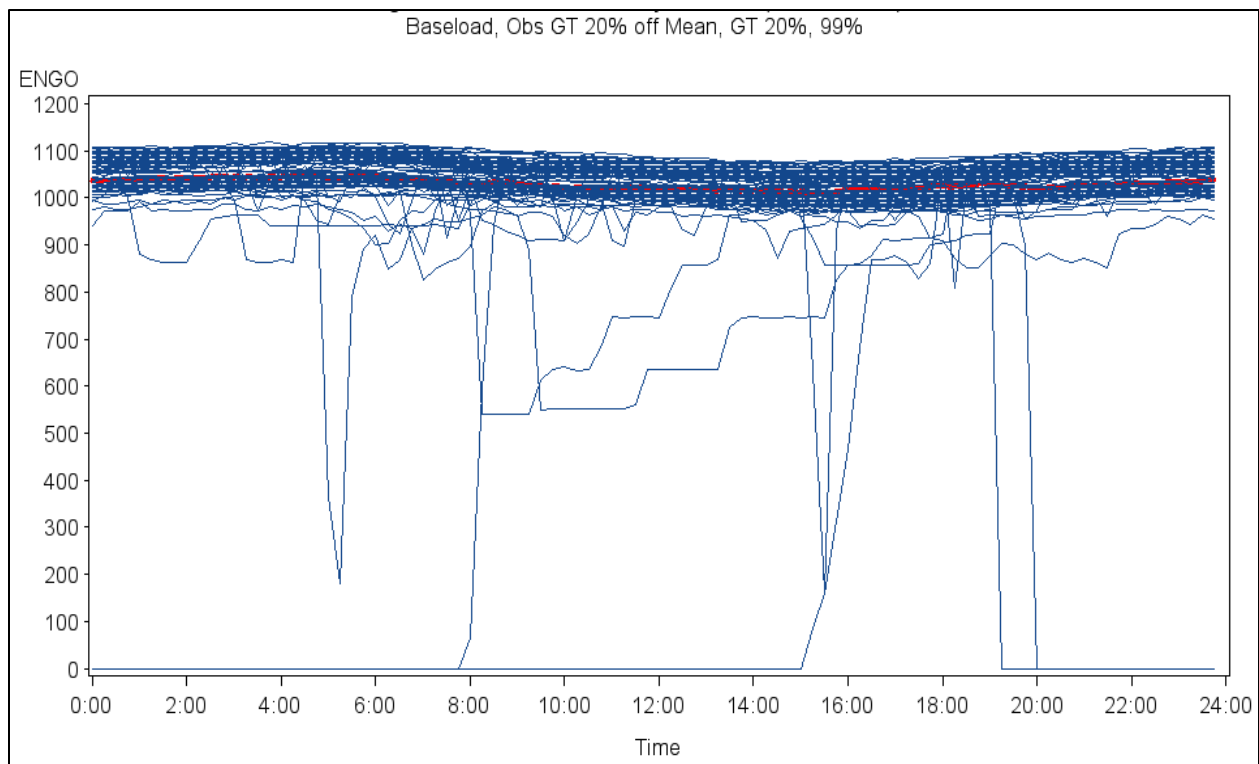
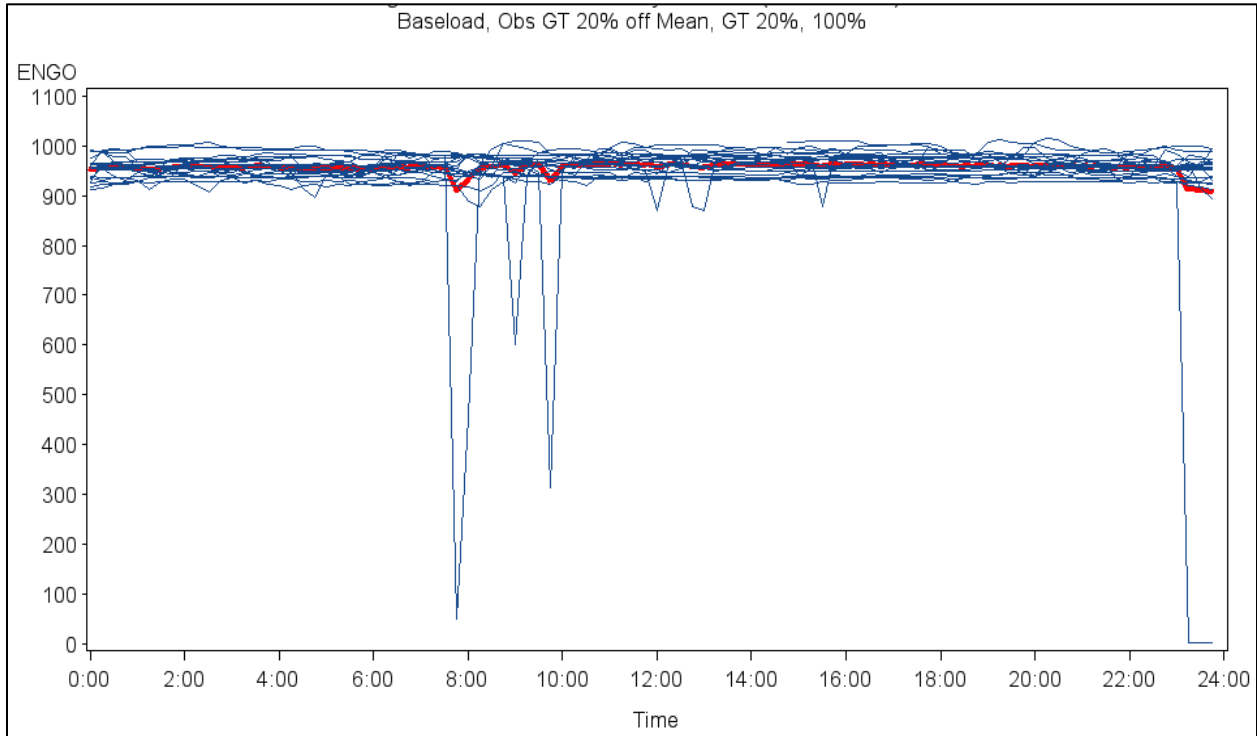

Figure A-20: Representative Gas Turbine Generator Profile (SCG: Process Application)



Although the applications are significantly different, both generation profiles are relatively flat. Review showed that all of the gas turbine projects deployed under the SGIP for which there was metered data matched the definition of baseload generation. As a result, for the purposes of this report, all gas turbine applications were considered base load technologies.

A.3.3 Current Technology Capital Costs

Gas turbine installation is a complex process, involving many different pieces of equipment. Even simple systems require installation of the gas turbine, gearbox, electric generator, inlet and exhaust ducting, inlet air-filtration, lubrication and cooling systems, standard heating system, and exhaust silencing.²⁷ This installation does not include fuel-gas compressor or emissions-controls. Table A-18 is a breakout of capital costs for basic gas turbine installations as provided by the EPA. The prices represent gas turbine systems utilizing water-treatment and heat recovery.

Table A-18: Capital Costs for Basic Installation Gas Turbines (2007 Pricing)

Cost Component	System 1 (1,000 kW)	System 2 (5,000 kW)
Combustion Turbines (\$1000)	1015	2733
Electrical Equipment (\$1000)	411	540
Fuel System (\$1000)	166	177
Water Treatment System (\$1000)	74	180
HRSG (\$1000)	508	615
Total Equipment (\$1000)	2713	4246
Construction (\$1000)	769	1402
Total Process Capital (\$1000)	2942	5648
Project/Construction Mgmt (\$1000)	271	402
Shipping (\$1000)	47	89
Development Fees (\$1000)	217	425
Project Contingency (\$1000)	116	177
Project Financing (\$1000)	230	431
Total Plant Cost (\$1000)	3822	7172
Actual Turbine Capacity (kW)	1150	5457
Total Plant Cost/net kW (\$)	3324	1314

Source: US EPA, *Catalog of CHP Technologies* (2008).

²⁷ Ibid.

Complex installation makes the gas turbine systems more expensive. These added expenses could be linked to a retrofit installation, special customer conditions, or other factors, such as continuous emissions monitoring or natural gas compression. The costs given by the US EPA in its CHP catalog can be compared to the costs of the systems installed under SGIP. As shown in Table A-19, the SGIP average costs match closely to the EPA Catalog prices. The SGIP costs also fall in between the values of the Simple and Complex Installations provided by the US EPA Catalog.

Table A-19: SGIP Pricing vs. US EPA Catalog Pricing (\$/kW)

	SGIP Average Cost per (\$/kW)	US EPA CHP Catalog (\$/kW)
<2 MW	3470	3324 – Simple Installation 5221 – Complex Installation
2 MW – 5 MW	2080	1314 – Simple Installation 2210 – Complex Installation

There was limited secondary information available for gas turbine installation costs. In addition, specific details on the cost components were often lacking. Consequently, the average installed cost from SGIP for gas turbines was used in the cost-effectiveness model.²⁸

²⁸ These system costs were adjusted to take into account additional NOx control costs at approximately \$700/kW for gas turbines smaller than 2 MW and approximately \$250/kW for the 2 to 5 MW size range.

A.3.4 Technology Operating and Maintenance (O&M) Costs

Maintenance for gas turbines includes “on-line running” maintenance, predictive maintenance, plotting trends, performance testing, fuel consumption, heat rate, vibration analysis, and preventive maintenance. Daily maintenance includes visual inspection of filters and site conditions. Routine inspections are required every 4,000 hours. Typical overhaul for these units is needed 25,000-50,000 hours (up to 5.7 years of continuous operation), and includes complete inspection and rebuilding of components to restore the system to performance standards. The typical O&M costs in Table A-20 below are based on typical service contracts, and include all routine maintenance including overhaul.²⁹

Table A-20: Non-Fuel O&M Costs

O&M Costs	System 1 (1,000 kW)	System 2 (5,000 kW)
Variable (service contract) (\$/kWh)	0.0060	0.0060
Variable (consumables) (\$/kWh)	0.0001	0.0001
Fixed (\$/kW-yr)	40	10
Fixed (\$/kWh) @ 8,000 hrs/yr	0.0050	0.0013
Total O&M Costs (\$/kWh)	0.0111	0.0074

Source: US EPA, *Catalog of CHP Technologies* (2008).

In addition to these O&M costs, an additional \$0.01/kWh of cost was added to account for reagents and fuel needed for operation of NOx controls. Consequently, O&M costs for gas turbines smaller than 2 MW was estimated at \$0.021/kWh and at \$0.017/kWh for gas turbines in the 2 to 5 MW size range.

Major One-Time Charges

Major engine overhaul is required every 25,000-50,000 turbine run hours. This consists of dimensional inspections, product upgrades and testing of the turbine and compressor, rotor removal, inspection of thrust and journal bearings, blade inspection and clearances, and setting packing seals.

²⁹ O&M costs are based on 8,000 operating hours expressed in terms of annual electricity generation. Fixed costs are based on an interpolation of manufacturers' estimates. The variable component of the O&M cost represents the inspections and overhaul procedures that are normally conducted by the prime mover original equipment manufacturer through a service agreement usually based on run hours.

A.3.5 Estimating Future Capital Costs

According to a report by Ernest Orlando Lawrence Berkeley National Laboratory, three classifications have been set up to categorize different points in technological development.³⁰ Mature Technologies are those that have saturated the market, have well-known characteristics, and have limited potential for cost reductions due to learning. Incremental Technologies are those that have niche market commercialization, and do have potential for a learning curve. Radical Technologies are those with no market share, and may never reach significant commercialization, yet have a high learning curve potential. Under these classifications, gas turbines were ranked at the Mature Technology level.³¹ The report concludes that there will only be a 5% cost of reduction for gas turbines by 2025.

Capital Equipment

Figure A-21 shows the worldwide output per year for small gas turbine broken out by the size classifications used in the cost-effectiveness model. The production volumes and cumulative quantities can be used to derive a learning curve.

Figure A-21: Worldwide Production (MW) per Year for Small Gas Turbines (2006-2008)

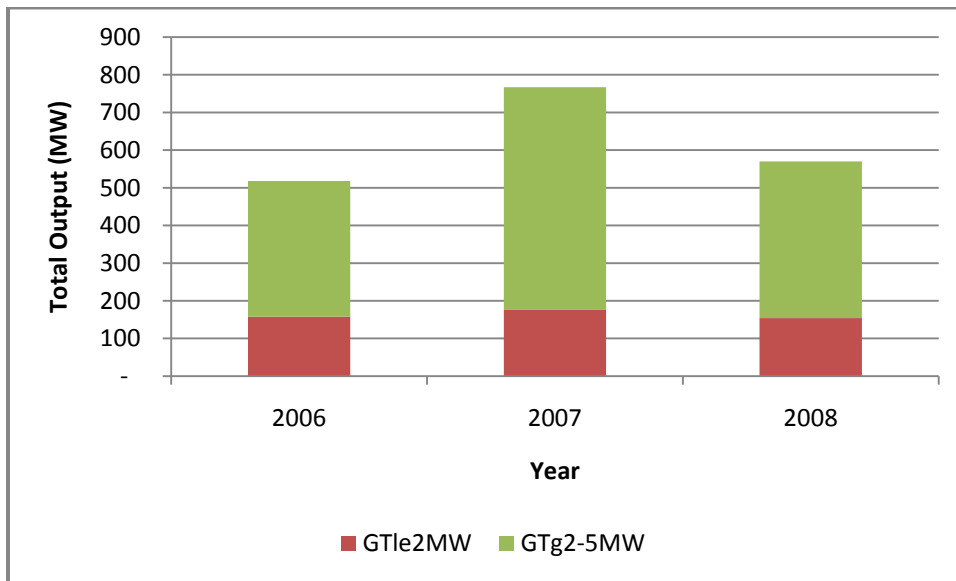

³⁰ Etan Gumerman, Chris Marnay, *Learning and Cost Reductions for Generating Technologies in the National Energy Modeling System (NEMS)*, Ernest Orland Lawrence Berkeley National Laboratory (2004).

³¹ Ibid.

Table A-21 is a listing of the volume production sales by year and gas turbine size classification based on surveys from Diesel & Gas Turbine Worldwide. The Power Generation Order Survey over the past several years by Diesel & Gas Turbine Worldwide show the number of sales worldwide of gas turbine engines over each year. From these surveys, the cumulative gas turbine sales can be found, and are shown in the table below.

Table A-21: Annual Sales of Gas Turbines

Year	< 2 MW Cumulative Capacity (MW)	2-5 MW Cumulative Capacity (MW)
2006	162	257
2007	320	617
2008	496	1208
2009	650	1624

Source: Diesel and Gas Turbine Worldwide, 2010 Power Generation Survey, http://www.diesलगasturbine.com/pdf/power_2010.pdf

The information from Table A-21 was used to find a rate of growth for both the less than 2 MW systems and the 2 to 5 MW systems. For the less than 2 MW systems, the decreasing growth rate was calculated to be -0.40%. The 2 to 5 MW systems had an increasing growth rate; calculated to be 21.42%.

Based on the previous discussion of historical costs and growth rates, we calculated a progress ratio of 95%. The progress ratio is used to develop learning curves shown in Figure A-22 for expected costs of small and large gas turbines through the year 2020.

Figure A-22: Learning Curves for Gas Turbines

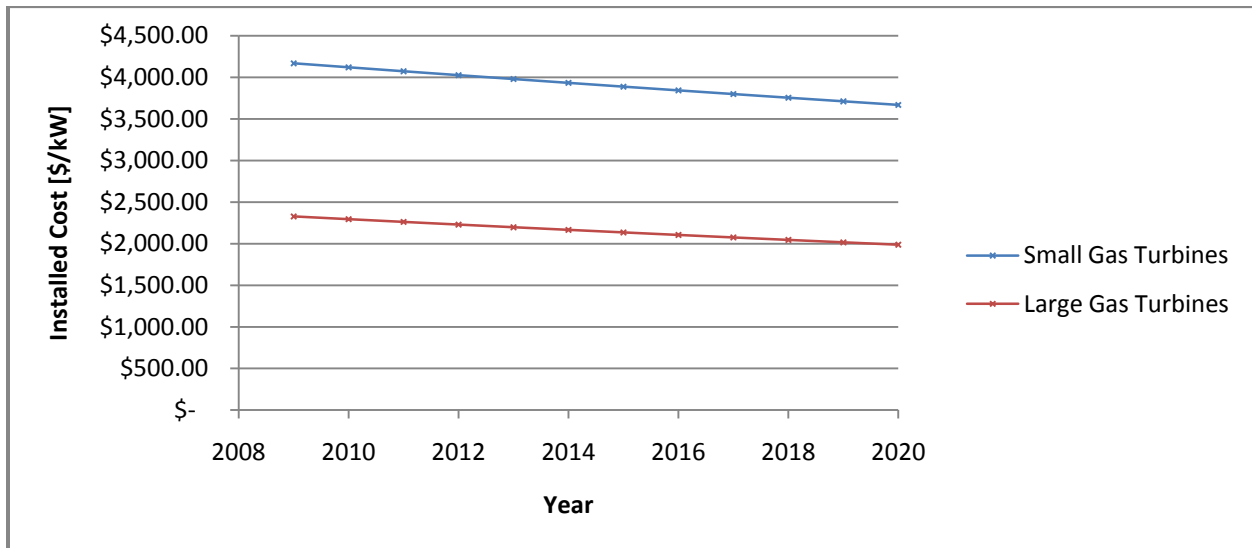

A.4 IC Engines

A.4.1 Technology Summary

There are two main engine designs used in power generation: the Otto Cycle (spark ignition) and the Diesel Cycle (compression ignition). The main difference between the two designs is in the fuels used and the operating pressures. Spark ignition engines can use natural gas, biogas, landfill gas, and propane for fuel. Spark ignition engines using natural gas have been commonly applied in California. The reciprocating internal combustion engine (IC engine) produces power through the ignition of a controlled air/fuel gaseous mixture. The air/fuel mixture is contained in a piston/cylinder chamber. Both engine designs use a four stroke cycle to convert the fuel into mechanical energy. This four stroke cycle consists of an intake stroke, compression stroke, combustion stroke, and an exhaust stroke. During the combustion stroke, the expanding combustion gases push a piston which turns an attached crankshaft. The crankshaft transmits torque and shaft power that turns a generator to produce electricity. IC engines range in capacity from 10 kilowatts (kW) to 5 megawatts (MW). Figure A-23 illustrates the components of an IC engine combined heat and power application. Major manufacturers include Caterpillar, Wartsila, GE Jenbacher, Deutz, and Waukesha. Natural gas is the most common fuel used in spark ignition engines for electric power generation and combined power and heat (CHP) applications.

Figure A-23: Combined Heat and Power System

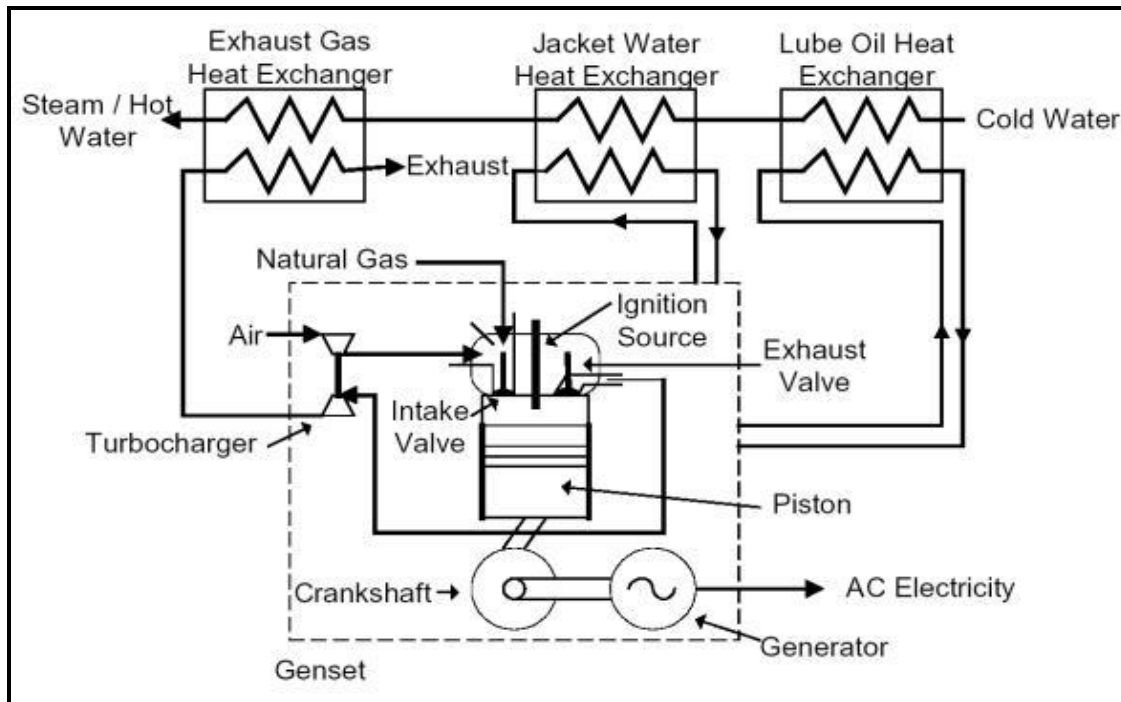

Source: http://www.energysolutionscenter.org/distgen/AppGuide/Chapters/Chap4/4-1_Recip_Engines.htm.

A.4.2 Past SGIP Applications

IC engines have been a very common CHP application under the SGIP with over 240 IC engine systems having been installed under the SGIP since its startup in 2001. Table A-22 is a listing of characteristics of IC engine systems installed under the SGIP. The table includes information on the number of installations, total rebated IC engine capacity (in MW), average installation capacity (kW), and average installed cost (\$/kW) broken out by IOU territory as well as by natural gas or biogas fuel type.

Table A-22: Summary of SGIP IC Engine Characteristics as of 12/31/2009

IOU	Natural Gas				Biogas			
	Number	Capacity	Avg	Cost	Number	Capacity	Avg	Cost
	(n)	(MW)	(kW)	(\$/Watt)	(n)	(MW)	(kW)	(\$/Watt)
PG&E	101	54.9	544	3.10	13	6.6	504	3.74
SCE	53	29.2	550	2.18	0	0.0	-	-
SDG&E	19	10.5	550	2.31	1	0.6	560	2.93
SCG	68	54.6	803	2.24	4	2.7	665	3.10
Subtotal:	241	149.1	619	2.59	18	9.8	543	3.55

There were significantly more natural gas-fueled IC engines installed under the SGIP (with a commensurately higher total rebated capacity) than those fueled by biogas. Not surprisingly, the average installation capacity was roughly the same (around 600 kW). In addition, the reported installed costs were higher for biogas-fueled IC engine systems than for natural gas-fueled IC engine systems, which makes sense if IC engines fueled by biogas had additional capital costs due to gas cleanup systems.

Figure A-24 shows the distribution of reciprocating IC engines in the SGIP by number of power generation units per output range category. The majority of the units in the program are less than 1 MW. Installation capacities range from 120 kW to 4110 kW with a mode of 150 kW. Only one unit in the program exceeds 4 MW.

Figure A-24: Power Generation by Size in SGIP

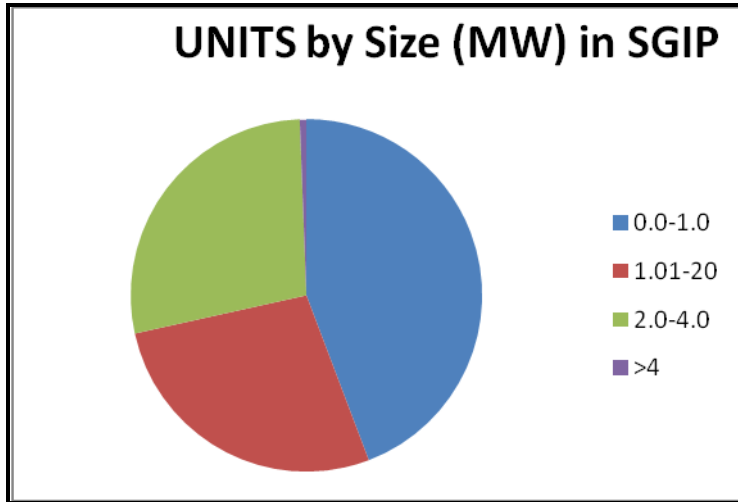
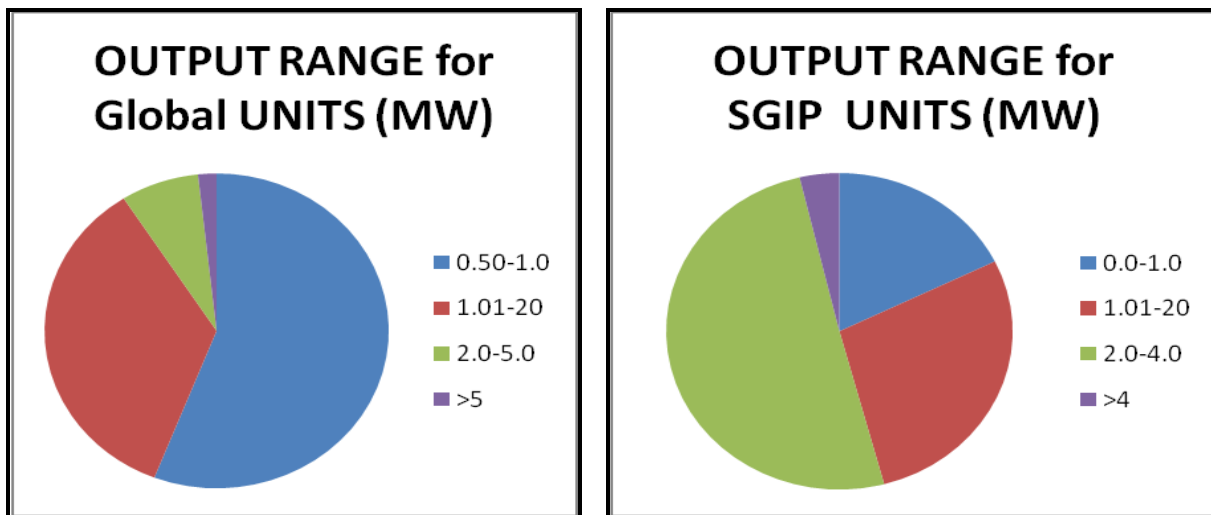

Figure A-25 compares the distribution of generation capacity in the SGIP to the distribution of capacity globally. Globally, over 50% of IC engine generation is under 1 MW. By comparison, over 50% of the generation capacity in the SGIP is over 1 MW range.

Figure A-25: Power Generation Worldwide and in SGIP



Source: Diesel & Gas Turbine Worldwide, Power Generation Order Survey. October 2009

A.4.3 Technology Operating Characteristics

Reciprocating IC engines are a very commonly used generation technology. IC engines are commonly used because they are relatively low cost, have high reliability and relatively short startup times. IC engines can be installed in a modular fashion to meet varying size and load needs. Multiple engines can be installed to meet the typical plant size ranges of 30 to 200MW. IC engine technology has also evolved and improved with use over a long time. Given proper maintenance, IC engines have proven to be reliable and have long operating lives. IC engines have also demonstrated availabilities of over 95%. A key disadvantage of IC engines is their relatively high NOx emissions. NOx emissions in particular have been problematic for IC engine eligibility under the SGIP.

Electrical Efficiency

An IC engine technology characterization study was conducted as part of EPA’s CHP Partnership Program. Table A-23 summarizes representative performance characteristics from four reciprocating IC engine systems analyzed under the technology characterization study.

Table A-23: Performance Characteristics of Four Representative IC Engine Systems

Performance Characteristics	System 1	System 2	System 3	System 4
Base load Electric Capacity (kW)	100	300	800	3,000
Electric Heat Rate (Btu/kWh), HHV	12,000	9,866	9,760	9,492
Electrical Efficiency (%), HHV	28.4%	34.6%	35.0%	36.0%
Engine Speed (rpm)	1800	1800	1800	900
Fuel Input (MMBtu/hr)	1.20	4.93	9.76	28.48
Required Fuel Gas Pressure (psig)	<3	<3	<3	43
<i>CHP Characteristics</i>				
Exhaust Flow (1000 lb/hr)	1.4	6.3	12.1	48.4
Exhaust Temperature (Fahrenheit)	1,060	939	909	688
Heat Recovered from Exhaust (MMBtu/hr)	0.28	1.03	1.85	4.94
Heat Recovered from Cooling Jacket (MMBtu/hr)	0.33	1.13	2.45	4.37
Heat Recovered from Lube System (MMBtu/hr)	0.00	0.00	0.00	1.22
Total Heat Recovered (MMBtu/hr)	0.61	2.16	4.30	10.53
Total Heat Recovered (kW)	179	632	1,260	3,084
Form of Recovered Heat	Hot H ₂ O	Hot H ₂ O	Hot H ₂ O	Hot H ₂ O
<i>Total Efficiency (%)</i>	<i>79%</i>	<i>78%</i>	<i>79%</i>	<i>73%</i>
Thermal Output/Fuel Input (%)	51%	44%	44%	37%
Power/Heat Ratio	0.56	0.79	0.79	0.97
Net Heat Rate (Btu/kWh)	4,383	4,470	4,385	5,107
<i>Effective Electrical Efficiency</i>	<i>0.78</i>	<i>0.76</i>	<i>0.78</i>	<i>0.67</i>

Source: Energy and Environmental Analysis Inc. (2008). *Technology Characterization: Reciprocating Engines*. Environmental Protection Agency Combined Heat and Power Partnership Program, Washington, DC.

In general, IC engines show electrical efficiencies ranging from 28% to 36% (HHV) equivalent to approximately 25% to 33% (LHV). IC engines also show high part-load efficiency. Efficiency ranges from 28-39% with a related load range of 30-100%. This means that an engine can cost-effectively match or follow the electric load demand within this window without a significant efficiency penalty. Figure A-26 illustrates this point and shows the relatively small divergence in efficiency compared to the part load.

Figure A-26: Efficiency Versus Part Load for IC Engines

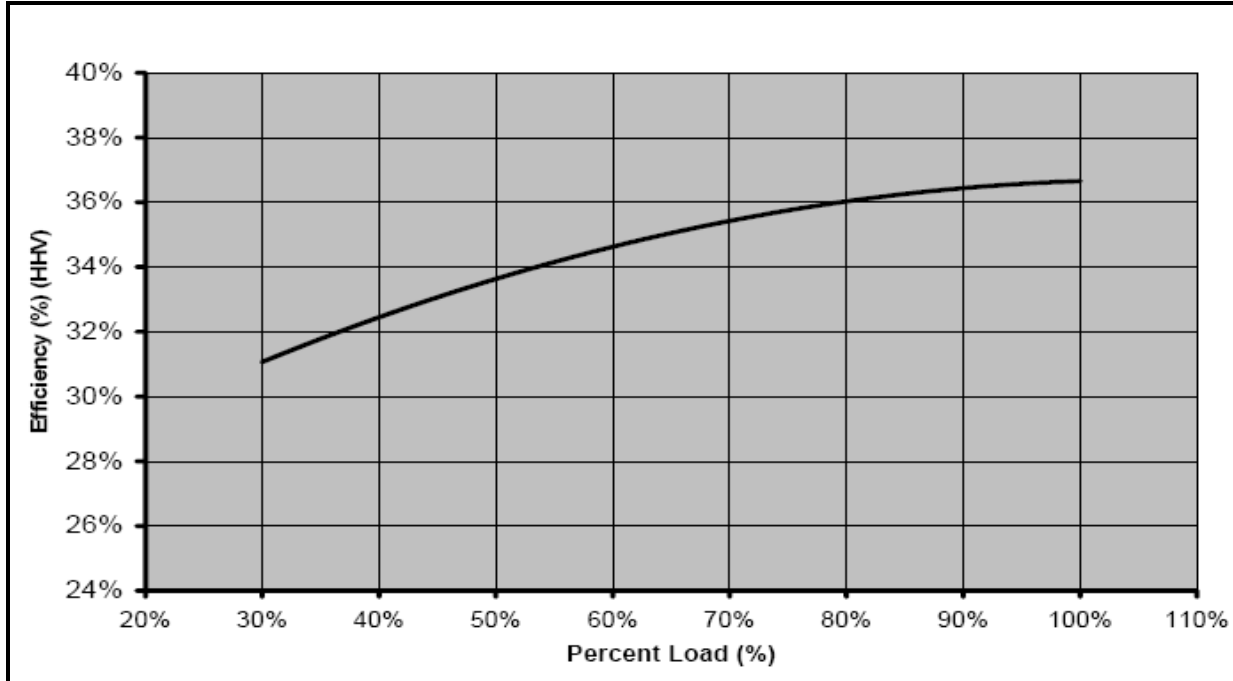

Source: Energy and Environmental Analysis Inc, “Technology Characterization: Reciprocating Engines,” Environmental Protection Agency, Combined Heat and Power Partnership Program, Washington, DC., 2008

Table A-24 lists electrical efficiency of IC engines as measured under program years 2008 and 2009. In general, the electrical efficiencies fall within the values listed for the EPA representative IC engine systems.

Table A-24: Electrical Efficiencies of IC Engines as Measured in the SGIP (2008-09)

Program Year	Metered Systems	Electric Efficiency
	n	(%, LHV)
2008	49	30.3% ± 14.4%
2009	63	31.3% ± 15.2%

Waste Heat Recovery

Waste heat recovery is a common application for IC engine systems. Fuel use efficiency can be significantly improved when IC engines are used to produce hot water or low pressure steam as in a coincident heat and power use application. Thermal efficiency ranges from 35-48% with overall efficiency increasing to over 70%.³²

Like fuel cells and gas turbines, useful waste heat recovery was metered under the SGIP. Table A-25 provides a summary of the measured useful waste heat recovery from 41 IC engine systems operating in the SGIP during calendar year 2009. The values represent observed useful waste heat recovery in units of thousands of Btu per kilowatt-hour of generated electricity (kBtu/kWh). Using an average electrical efficiency for IC engines of approximately 31% and the CPUC requirement of at least 60% overall efficiency, IC engine systems were assumed to have the ability to recover 3.19 kBtu of useful waste heat per kWh of generated electricity for the purposes of this study.

Table A-25: Useful Waste Heat Recovery from SGIP IC Engine Systems (2009)

Year	Metered Sites	Waste Heat Recovery (kBtu/kWh)			
	n	min	max	mean	Capacity Weighted Average
2009	41	0	8.12	1.24	3.07

Air Pollution Emissions

Lean air/fuel mixtures are used in natural gas engines to reduce engine cylinder temperatures and reduced NOx emissions. Most major IC engine manufacturers offer lean burn, low emissions engine models. Consequently, to achieve CARB 2007 air emissions standards, most IC engines used for power generation applications use a burn lean design in combination with a post-combustion control system. Typical post-combustion systems include Selective Catalytic Reduction (SCR) for NOx and oxidation catalysts to control CO and VOC or Non-Selective Catalytic Reduction (NSCR) systems. Table A-26 shows emission characteristics for IC engine systems. Table A-27 shows typical NOx emissions systems for rich burn and lean burn engines and examples of operational engine results. Air pollution control equipment can add a significant cost to the overall equipment and maintenance costs of a project. The ammonia and urea used for SCR applications also adds new health and safety issues.

³² Energy and Environmental Analysis Inc., “Technology Characterization: Reciprocating Engines,” Environmental Protection Agency, Combined Heat and Power Partnership Program, Washington, DC. (2008).

Table A-26: Typical Emission Characteristics of IC Engine Systems

Emission Characteristics	System 1	System 2
Electricity Capacity (kW)	300	1000
Electrical Efficiency (HHV)	31.10%	35.00%
Engine Combustion	Rich	Lean
Exhaust Treatment	TWC system with EGR	SCR system
NO _x , (lb/MWh)	0.5	1.49
CO, (lb/MWh)	1.87	0.87
VOC, (lb/MWh)	0.47	0.38
CO ₂ , (lb/MWh)	1,284	1,142

Source: Energy and Environmental Analysis Inc., “Technology Characterization: Reciprocating Engines,” Environmental Protection Agency, Combined Heat and Power Partnership Program, Washington, DC. (2008)

Table A-27: Typical NO_x Emissions for IC Engine Systems

Combustion Type	Typical NO _x (lb/MWh)	NO _x Target with Exhaust Controls (lb/MWh)	Example	Typical NO _x (lb/MWh)	Emissions Control
Rich burn	0.10	0.07	Coast Intelligen 150-IC 150kWe	0.441	NSCR
Lean burn	1.25	0.07	Wartsila 34SG 5MWe	0.223	SCR

Source: IC engine manufacturer specification sheets.

Ramp Rates and Generator Profiles

IC engines can be operated in a baseload or load following configuration. IC engines have a rapid ramp rate response and can be quickly brought on line to supply an electric load demand. Ramp rates range from 8-600 kW per minute.³³

³³ Burns & McDonnell, “Flexible Power—Alternative Generation Sources for the Changing Power Market,” TECHBriefs 2009, No. 3, 2009.

Metered data was collected on a relatively large number of IC engine systems deployed under the SGIP. In a number of instances, 15-minute electricity generation data was collected over the course of a full year (i.e., 8760 hours). To assess the load following aspects of the different DG technologies, hourly load profiles across the 2008 calendar year were developed. Figure A-27 and Figure A-28 are representative generation profiles for IC engine system deployed under the SGIP in the SCG and PG&E service territories, respectively. Figure A-27 is based on an occupancy application, such as that seen in gyms, and shows a distinctive step load following profile. Figure A-28 is another occupancy based application but shows a primarily base-load profile. Due to its ability to operate in either a base-load or load-following configuration, IC engine systems were modeled both ways in the study.

Figure A-27: Representative IC Engine Generator Profile (SCG: Occupancy Application)

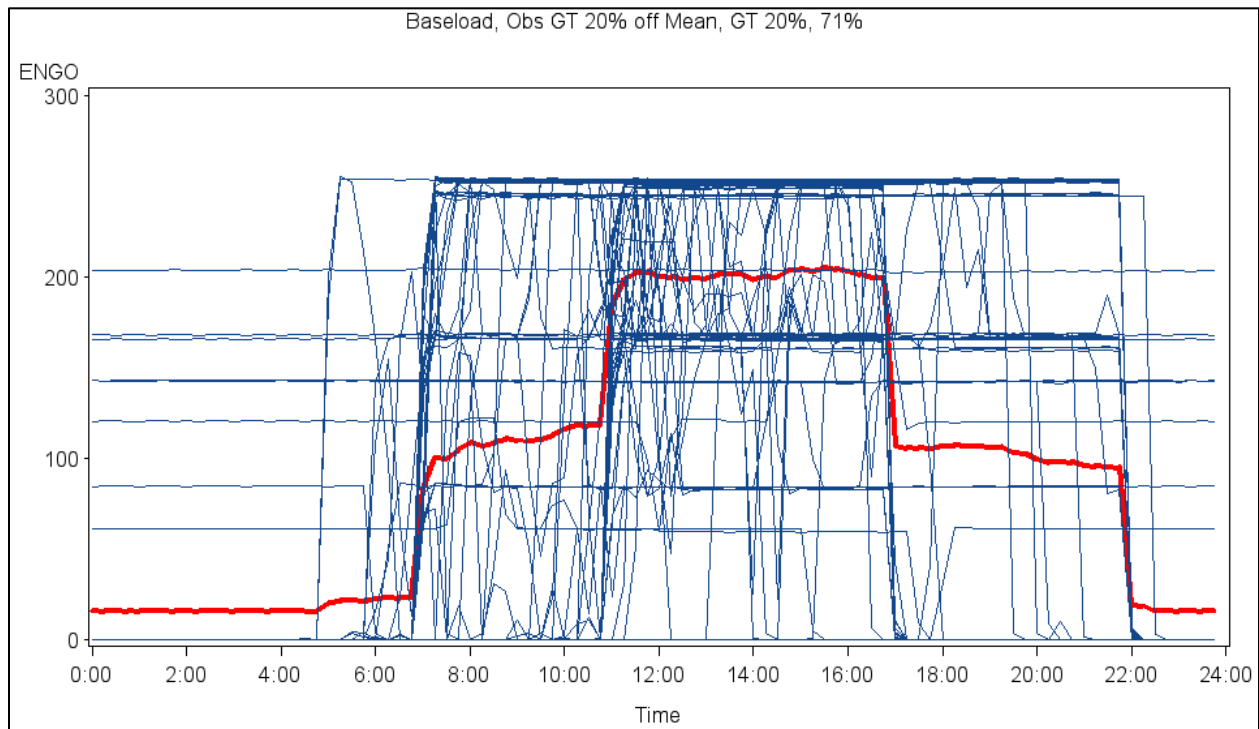
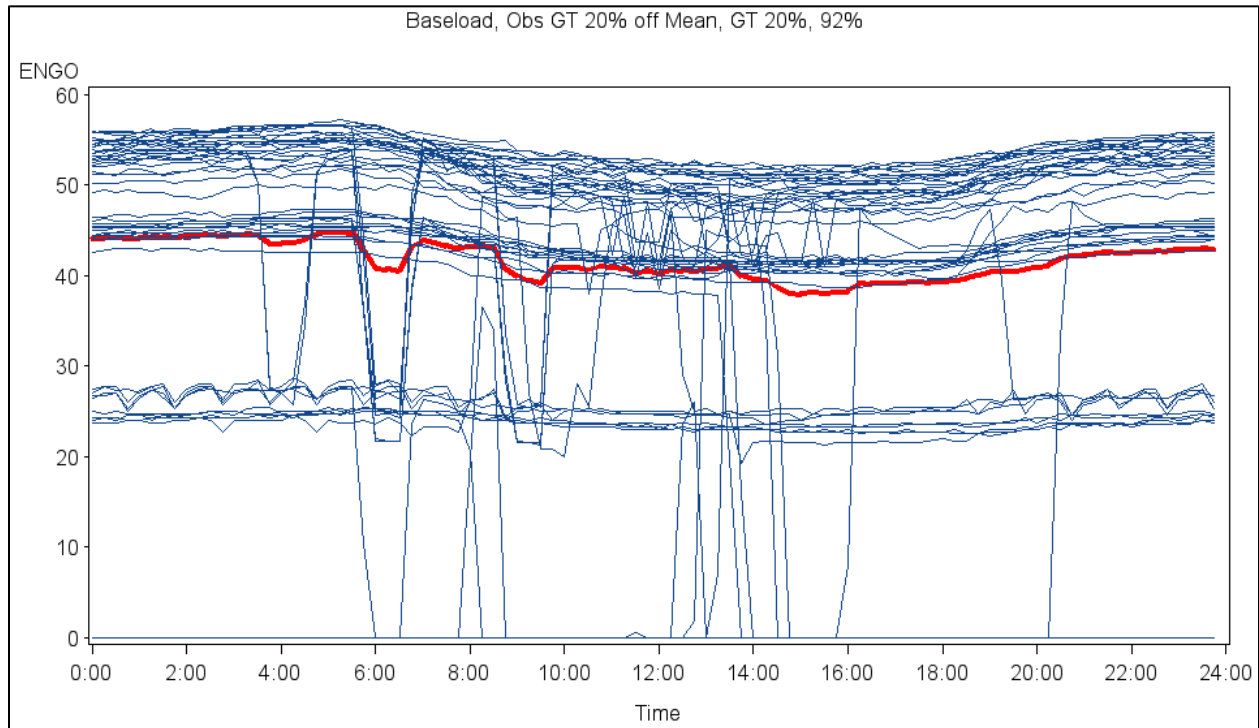

Figure A-28: Representative IC Engine Generator Profile (PG&E: Occupancy Application)



A.4.4 Current Technology Capital Costs

Table A-28 shows typical installed costs for IC engine systems that could be installed under the SGIP. Installed costs of 500 kW IC engine systems were estimated at \$2,095/kW while costs for 1500 kW IC engine systems were estimated at \$1,795/kW. Note that these costs reflect air emissions control equipment that would be needed for IC engine systems to meet CARB NOx requirements.

Table A-28: Typical IC Engine System Capital Costs in California

IC engine System Components and Costs (\$/kW)	Average IC engine System Size (kW)	
	500	1,500
Equipment	\$880	\$760
Labor	\$235	\$200
BOP	\$362	\$320
Additional Air Pollution Control	\$155	\$155
Other Costs	\$60	\$40
System Cost (\$/ kW)	\$1,692	\$1,475
Waste Heat Handling System (If Separate)		
Equipment	\$240	\$190
Labor	\$65	\$50
BOP	\$98	\$80
Waste Heat Handling Cost (\$/kW)	\$403	\$320
Total System Cost (\$/kW)	\$2,095	\$1,795

Source: SGIP cost data and Itron phone interviews with sites and manufacturers.

In comparison, Table A-29 illustrates typical U.S. capital costs for IC engine systems across five different sizes.

Table A-29: Typical Capital Cost for IC Engine Systems in the U.S.

Cost Component	System 1	System 2	System 3	System 4	System 5
Nominal Capacity (kW)	100	500	1000	3000	5000
Equipment	Costs (\$/kW)				
Gen Set Package	\$1,000	\$880	\$760	\$520	\$590
Heat Recovery	\$110	\$240	\$190	\$80	\$50
Interconnect/Electrical	\$260	\$60	\$40	\$30	\$20
<i>Total Equipment</i>	<i>\$1,370</i>	<i>\$1,180</i>	<i>\$990</i>	<i>\$630</i>	<i>\$660</i>
Labor/Materials	\$340	\$300	\$250	\$240	\$250
Total Capital Costs	\$1,710	\$1,480	\$1,240	\$870	\$910

Source: Energy and Environmental Analysis Inc. (2008). Technology Characterization: Reciprocating Engines. Environmental Protection Agency, Combined Heat and Power Partnership Program, Washington, DC.

A.4.5 Technology Operating and Maintenance (O&M) Costs

Maintenance costs include routine replacement of engine oil and filters, engine coolant, and spark plugs. Engine manufacturers recommend routine maintenance from 500 to 2000 hours and a major overhaul at 30,000 and 72,000 hours of operation. Table A-30 shows the O&M costs used in the cost-effectiveness model for IC engine systems.

Table A-30: O&M Costs for IC Engine Systems

Cost Component	System 1	System 2
Nominal Capacity (kW)	500	1500
O&M Costs (\$/kWh)	\$0.0124	\$0.0073

Source: US EPA, *Catalog of CHP Technologies* (2008) and Itron phone interviews.

A.4.6 Estimating Future Capital Costs

A learning curve was developed using cumulative CHP IC engines installed and capital cost data. The learning curve is shown in Figure A-29. The learning curve ratio was estimated at 5%. This ratio was used to estimate future capital costs and implies that when the cumulative capacity doubles, the capital cost will be reduced a modest 5%. This result demonstrates that IC engine is a mature technology which has saturated the market. Capital cost reductions due to learning experience are very limited.

Figure A-29: Learning Curve for IC Engine Systems (2008 to 2020)

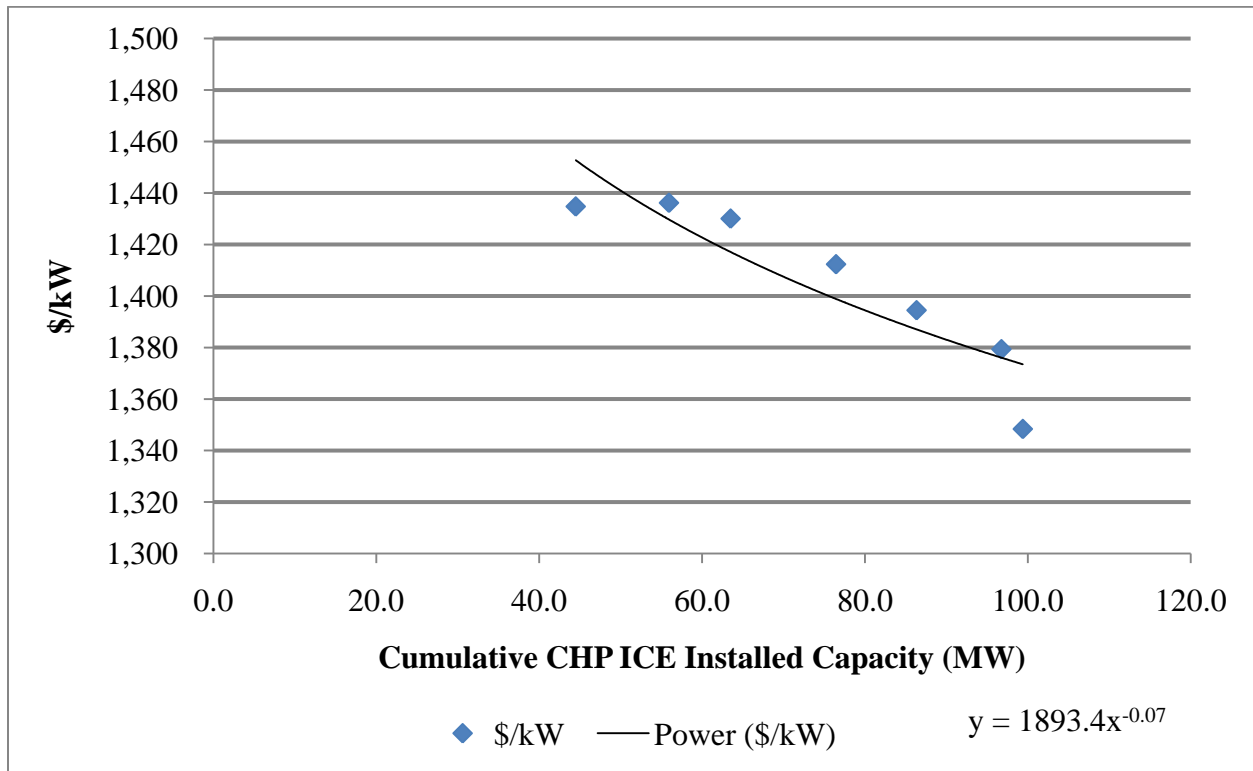

A.4.7 Impact Of Learning Curve On Capital

Table A-31 shows the Power Generation Order Survey results by Diesel & Gas Turbine Worldwide for the past four years. This information shows an overall cumulative IC engine generation capacity growth rate of 64%. CHP cumulative capacity growth rate for the same period is 41%. However, CHP installations during the same period decreased by 38%. The learning ratio for CHP applications is 4% which is in line with the volume of IC engine produced annually. The learning ratio is the projected cost reduction achieved each time the cumulative capacity doubles.

Table A-31: IC Engine Generation and CHP Capacity

Year	Annual Power IC Engine Generation Capacity (MW)	Cumulative Total Power IC Engine Generation Capacity (MW)	CHP Cumulative Total Capacity (MW)
2006	35,381	35,381	90.3
2007	38,085	73,466	159.2
2008	44,814	118,280	231.9
2009	38,097	156,377	250.2

A.5 Microturbines

A.5.1 Technology Summary

Microturbines are small electricity generators that burn gaseous and liquid fuels to create high-speed rotation that turns an electrical generator. The size range for microturbines available and in development is from 30 to 250 kilowatts (kW). These systems operate on the same thermodynamic cycle as the larger gas turbines, known as the Brayton Cycle. They are able to run on a variety of fuels, including natural gas, sour gases (high sulfur, low Btu content), and liquid fuels such as gasoline, kerosene, and diesel fuel/distillate heating oil. In resource recovery applications, they burn waste gases that would otherwise be flared or released directly into the atmosphere. This can include landfills and coal mines where byproduct gases serve as essentially free fuel.

Figure A-30: Simple Schematic of Microturbine-Based CHP System

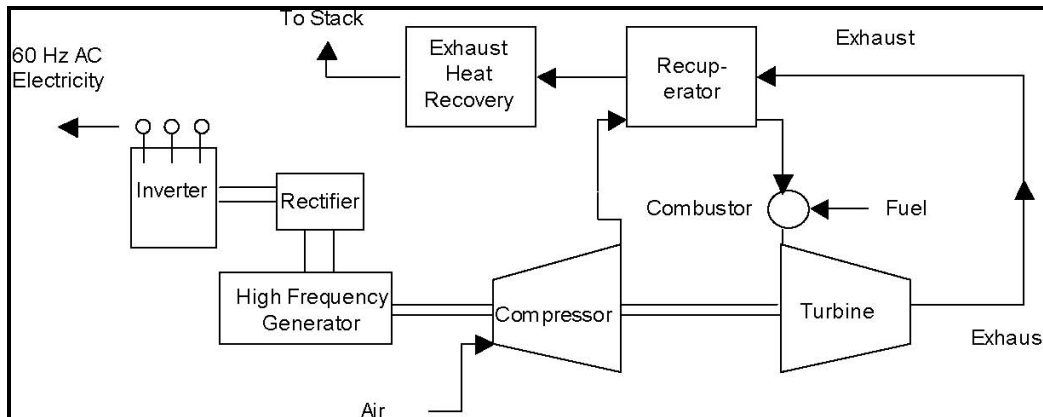

Source: Energy Nexus Group. "Technology Characterization: Microturbines." Catalog of CHP Technologies. 2008.

Basic components of the microturbine system include the combustor, compressor, turbine, and recuperator (Heat Exchanger). Thermal output of these systems can range from 400-600 °F, which is high enough to be used to heat building space, drive absorption chillers, produce hot water, or to supply other thermal needs in building or industrial processes. Microturbine manufacturers claim that microturbines have an estimated lifetime of 40,000-80,000 hours. However, as this is relatively new technology, the actual lifetime has not yet been demonstrated.

Several of the main manufacturers of microturbines are shown in Table A-32.

Table A-32: List of Microturbine Manufacturers

Company	Microturbine Size (kW)	Website
Bowman Power Systems	80	http://www.bowmanpower.com/
Capstone Turbine Corp.	30-200	http://www.capstoneturbine.com/
Ingersoll-Rand Energy Systems	70, 250	http://www.ingersollrandproducts.com/
Turbec AB	100	http://www.turbec.com/

Capstone Turbine Corporation is currently the world leader in production of microturbines and is headquartered in Los Angeles. Capstone represents about 70 to 80% of the total units sold in the world market annually. The majority of Capstone's units sold are their 65kW system, making it the most commonly sold microturbine unit on the market today.

A.5.2 Past SGIP Applications

As of the end of 2009, over 140 microturbines had been installed under the SGIP. Table A-33 lists characteristics of microturbines deployed under the SGIP including number of installations, total rebated IC engine capacity (in MW), average installation capacity (kW) and average installed cost (\$/kW) broken out by IOU territory as well as by natural gas or biogas fuel type. Nearly 90% of the installed microturbine systems were fueled by natural gas and accounted for close to 90% of the installed microturbine capacity. The remaining 10% of the microturbine systems were fueled by biogas. As expected, capital costs of biogas-fueled microturbines was nearly 40% higher than their natural gas-fueled counterparts.

Table A-33: Summary of SGIP Microturbine Characteristics as of 12/31/2009

IOU	Natural Gas				Biogas			
	Number	Capacity	Avg	Cost	Number	Capacity	Avg	Cost
	(n)	(MW)	(kW)	(\$/Watt)	(n)	(MW)	(kW)	(\$/Watt)
PG&E	42	8.2	196	4.19	14	2.0	146	5.09
SCE	28	5.3	190	3.07	-	0.0	-	-
SDG&E	13	1.1	87	3.06	4	0.8	195	2.72
SCG	40	7.0	175	2.75	-	0.0	-	-
Subtotal:	123	21.7	176	3.35	18	2.8	157	4.56

A.5.3 Technology Operating Characteristics

Performance of a microturbine can be evaluated based on the electrical conversion efficiency and heat rate.

Electrical Efficiency

Similar to gas turbines, microturbine electrical efficiency can be tied to heat rate through the following equation:

$$\text{Electrical Efficiency } (\varepsilon) = \frac{3413 \left(\frac{kBtu}{kWh} \right)}{\text{Heat Rate } \left(\frac{kBtu}{kWh} \right)}$$

Two common microturbine systems used in the U.S. marketplace are the Capstone C65 and the Ingersoll Rand MT 250. According to the manufacturer specification sheets, the heat rate for the Capstone C65 is 11,800 Btu/kWh (LHV), while the heat rate for the Ingersoll Rand MT 250 is

11,500 Btu/kWh (LHV). As such, electrical efficiencies for the Capstone C65 and Ingersoll-Rand IR75 are rated at 29% and 30% (LHV), respectively. In contrast, measured data for microturbines installed under the SGIP showed electrical efficiencies of approximately 22%.³⁴

Many factors can affect the efficiencies of microturbine systems. Ambient temperatures have a noticeable effect on both the power output and efficiency of these units. Decreased air mass flow rates will result in a power decrease, while efficiency decreases because the compressor requires more power to compress air of higher temperature. The same effect goes for altitude changes. It takes more work for the microturbine to compress the higher-altitude, less dense air, reducing the efficiency of the units. Figure A-31 from Capstone shows how its C65 model performs with changes in ambient air temperature. For the purposes of this study, microturbines were assumed to have an electrical efficiency of approximately 22-24% (LHV).

Figure A-31: C65 Net Power & Efficiency vs. Ambient Temperature at Sea Level

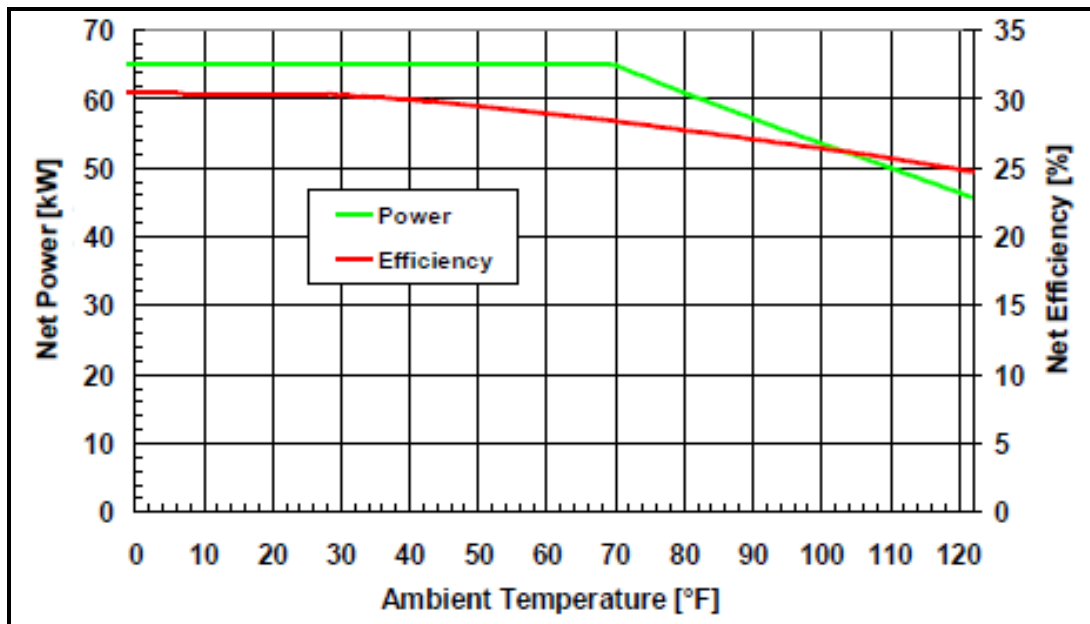

Source: Capstone Turbines, Specification Sheet for C65 System.

³⁴ Itron, CPUC Self-Generation Incentive Program: Eighth-Year Impact Evaluation Report, June 2009, pg.5-39.

Waste Heat Recovery

Like other CHP systems deployed under the SGIP, useful waste heat recovery was metered for microturbines. Table A-34 provides a summary of the measured useful waste heat recovery from 43 microturbine systems operating in the SGIP during calendar year 2009. The values represent observed useful waste heat recovery in units of thousands of Btu per kilowatt-hour of generated electricity (kBtu/kWh). Using an average electrical efficiency for microturbines of approximately 24% and the CPUC requirement of at least 60% overall efficiency, microturbine systems were assumed to have the ability to recover 5.89 kBtu of useful waste heat per kWh of generated electricity for the purposes of this study.

Table A-34: Useful Waste Heat Recovery from SGIP Microturbine Systems (2009)

Year	Metered Sites	Waste Heat Recovery (kBtu/kWh)			
	n	min	max	mean	Capacity Weighted Average
2009	43	0	5.26	0.95	2.21

Air Pollution Emissions

Low inlet temperatures and high fuel-to-air ratios result in low NOx emissions. Based on manufacturer’s specification sheets, the Ingersoll-Rand IR250 and Capstone C65 units have NOx emissions less than 5 PPM and 4 PPM (LHV), respectively. These numbers can be compared with the NOx emissions from a report by Energy Nexus Group (listed in Table A-35), estimating manufacturer emissions characteristics for three different microturbine systems.

Table A-35: Microturbine Emissions Characteristics

Pollutant	System 1	System 2	System 3
CO ₂ (lb/MWh)	1,736	1,597	1,377
NOx (lb/MWh)	0.54	0.22	0.29
NOx (ppmv)	9	4	5
CO (lb/MWh)	1.46	0.30	0.14
THC (lb/MWh)	0.19	0.09	0.10

Adapted from Energy Nexus Group, "Technology Characterization: Microturbines," *Catalog of CHP Technologies*, 2008.

Ramp Rates and Generator Profiles

The Consortium for Electric Reliability Technology Solutions (CERTIS) has studied the behavior of microturbines during load changes. At higher load settings, step changes were accomplished at a rate of 1.2 to 3.6 seconds per kW whereas at lower load settings, step changes were accomplished at a rate of 4.4 to 7.6 seconds per kW. CERTIS concluded that for Capstone units, the transition time during power increase and decrease were much faster when the microturbine power output was above 10 kW.

Capacity Factor

Capacity factor compares the plant's actual production over a given period of time with the amount of power the plant would have produced if it had run at full capacity for the same amount of time).

From the handbook of microturbine generators, a typical capacity factor for a microturbine is around 20 to 60%. From SGIP metered data taken between 2006 and 2008, the average annual capacity factor for microturbines was found to be approximately 45%.

A.5.4 Current Technology Capital Costs

The total capital costs for microturbines can be broken down into the equipment cost and other costs required for installing the system. Historical data of basic equipment cost was obtained from Form-10K of Capstone Turbine Corporation’s financial reports. Basic equipment cost includes the cost of turbogenerator package, heat recovery equipment and gas booster compressor. Table A-36 lists the basic equipment cost of microturbine per kW.

Table A-36: Levelized Microturbine Equipment Costs

	2007	2008	2009	2010*
Dollars per kW	968	968	950	846

Source: Capstone Turbine Financial Reports.

<http://phx.corporate-ir.net/phoenix.zhtml?c=120708&p=irol-reportsannual>

* Note: the cost per kW for 2010 was obtained from the estimates in the 2009 financial report.

The other costs include labor, material, piping, engineering and project management costs. These costs are often referred to as *soft costs* because they vary widely with the installation and are site-specific. These costs are discussed in the following sections.

Costs in SGIP

From 2001 onwards, 142 microturbine projects were rebated under the SGIP. Table A-37 summarizes installed costs of the 142 microturbine systems deployed under the SGIP from 2001 through 2008. Out of the 142 projects, 26 or 18% had the capability of using fuel from a renewable source. Information on the total installed cost for each of the rebated projects was obtained from the SGIP PAs. Based on the SGIP data, the average total installed cost for microturbines using non-renewable fuel was \$3,146/kW, while those employing renewable fuel was slightly higher at \$3,972/kW.

Table A-37: Weighted Average Install Costs for Microturbines Installed in the SGIP

Year	MT using Non-Renewable Fuel		MT using Renewable Fuel	
	Count	Weighted Average Cost per kW	Count	Weighted Average Cost per kW
2001	--	--	1	\$3,013.71
2002	23	\$3,195.53	2	\$2,825.30
2003	18	\$2,730.72	5	\$2,592.72
2004	24	\$3,249.55	5	\$4,038.53
2005	31	\$2,920.29	8	\$4,783.44
2006	6	\$3,190.74	1	\$2,607.38
2007	11	\$3,372.45	2	\$3,167.49
2008	3	\$3,780.52	2	\$7,968.18
All	116	\$3,146.64	26	\$3,972.18

SGIP cost data clearly shows that the cost for installing microturbines depends on number of factors. The weighted average installed cost of microturbines using non-renewable fuel based on SGIP data was around \$3150 per kW. Since the cost of the microturbine from the manufacture was close to \$950 per kW, the remaining \$2,200 per kW was treated as the average cost required to install the system. The installation was assumed to include the cost of installation labor and materials, distributor markup, engineering, project management, piping, and financial carrying costs during the construction period.

A.5.5 Conclusion on Capital Costs

The main conclusion after reviewing the costs associated with installing a microturbine is that the total cost varies on lot of factors associated with the site. Based on the SGIP data, the total

levelized cost for installing microturbines utilizing non-renewable fuel was \$1,050 to \$6,390 per kW. Basic equipment cost is standard across all the sites but the total cost of installation varied for each facility. The installation cost accounts for a number of different factors, including labor and materials, engineering work, materials, grid connection, and vendor mark-up, among others. Many of these factors are site-specific, and cannot be generalized across all sites where these turbines are installed.

Based on the above mentioned factors, the total cost for installing a microturbine was obtained by adding the equipment cost from Capstone (around \$950 per kW) , labor cost from EPA CHP catalog (around \$400 per kW) and other costs from SGIP (around \$1800 per kW). The total levelized installed cost of a microturbine is \$3,150 per kW.

A.5.6 Technology Operating and Maintenance (O&M) Costs

Ongoing Operations

Microturbines will require regular maintenance and the requirements will vary with fuel type, site conditions and type of operation. Typical schedule for a Capstone microturbine includes the following:

- Replace air and fuel filters after 8,000 hours
- Inspect/replace fuel injectors, igniters, thermocouples after 16,000–20,000 hours
- Replace battery (stand-alone units) after 20,000 hours
- Major overhaul, core turbine replacement after 40,000 hours

Typical O&M costs reported by Energy Nexus Group have been listed in Table A-38. These costs include regular scheduled maintenance and also include the costs associated with major overhaul at 40,000 hours or approximately close to five years of continuous operation. For the purposes of this study, microturbines were assumed to have O&M costs of \$0.02/kWh.

Table A-38: Typical Microturbine Maintenance Costs*

Cost Component	System 1	System 2	System 3
Nominal Capacity (kW)	30	65	250
O&M Costs – Service Contract, \$/kWh	\$0.015-\$0.025	\$0.013-\$0.022	\$0.012-\$0.020

* Based on full service maintenance contracts provided by the manufacturer.

Source: EEA/ICF

Major One-Time Charges

Major engine overhaul is required every 30,000-40,000 turbine run hours. This will include replacing the main shaft with the turbine and compressor attached, and inspecting and possibly replacing the combustor. Other components of the system should be inspected at this same time, to determine if excessive wear has occurred. Cost of the major overhaul can range from \$550/kW-\$800/kW.³⁵

A.5.7 Estimating Future Capital Costs

Capital Equipment

Capstone financial reports were obtained for the last four years, which include the levelized capital cost of their microturbines. Their costs are for the microturbine units only, and not for the costs associated with installing the equipment.

The following table shows the installed capacity, engine cost and total installed cost per kW for the capstone units for each year.

Table A-39: Summary of Microturbines Installed Capacity and Cost (Adapted from Capstone Annual Financial Reports)

	2007	2008	2009	2010
Installed Capacity (MW)	15.6	22.4	34.1	53.5
Cumulative Installed Capacity (MW)	15.6	38.0	72.1	125.6
Engine Cost per kW	968	968	950	846
Total Cost Per kW	3168	3168	3150	3046

Based on the cumulative capacity for the last four years, microturbine growth rate was estimated at 51%. This growth rate was used to estimate the cumulative installed capacity until 2020. Also, using the cumulative production data and total cost per kW, the progress ratio was calculated to be 98.4%. The growth rate and progress ratio were used in the cost-effectiveness model to forecast the system prices through the year 2020. Figure A-32 depicts the learning curve developed for microturbines from 2008 to 2020.

³⁵ Energy Nexus Group. "Technology Characterization: Microturbines." Catalog of CHP Technologies. 2008.

Figure A-32: Learning Curves for Microturbines (2008 to 2020)

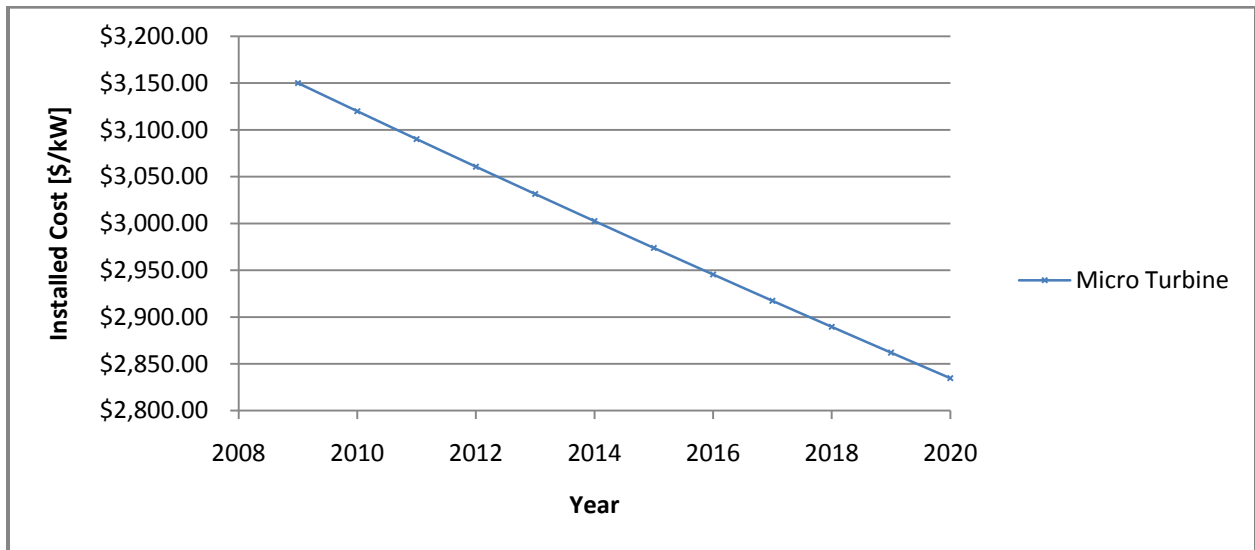

A.6 Organic Rankine Cycle

A.6.1 Technology Summary

Organic Rankine Cycle (ORC) refers to a waste heat recovery system which uses an organic, low boiling point working fluid to generate electricity through a Rankine cycle. The most common Rankine Cycle engine uses steam. A Rankine cycle typically consists of four parts: a pump, an evaporator, an expander and a condenser. Figure A-33 illustrates a simple Rankine cycle system.

Figure A-33: Simplified Rankine Cycle

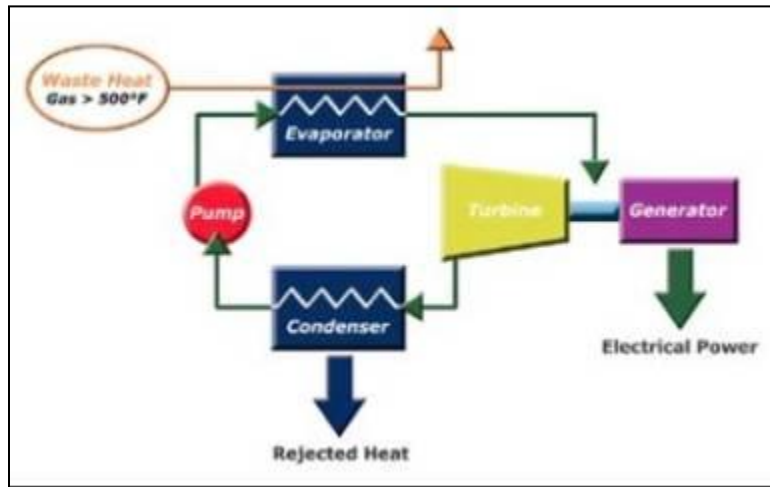

Source: http://www.stowa-lectedtechnologies.nl/Sheets/Sheets/ORC%200706_files/image002.jpg

In an ORC system, the working fluid is boiled in the evaporator into a vapor phase. The vapor expands, rotating a turbine that is then used to drive a generator. The exhaust vapors from the turbine are cooled into a liquid in the condenser. A pump is used to recirculate the working fluid from the condenser to the evaporator for the process to start again. Heat is absorbed in the system at the evaporator and removed from the system at the condenser.

ORC system working fluid characteristics are determined by the heat source temperatures. ORC systems typically use organic materials such as silicone oil and pentane as the working fluid. These compounds have low boiling points that can match the available heat. Waste heat suitable for ORC power plants can come from gas turbines and reciprocating engines. Temperatures of waste heat available ranges from 370-540 °C and 230-600 °C for gas turbines and reciprocating engines, respectively

ORC requires little maintenance and its operations can be automated. It has good part load performance. The efficiency of ORC is estimated at 10-20% and is dependent on the temperature difference between the evaporator and condenser. A greater temperature difference results in a higher efficiency.

Benefits from ORC systems include the following:

- The ORC organic fluid has a lower freezing point than water, allowing the condenser to transfer heat at a lower temperature, increasing cold weather performance.
- ORC condensers are typically air-cooled, enhancing their use in remote locations and eliminating disposal issues for cooling-water treatment chemicals.
- Organic working fluid condensing pressure is above atmospheric pressure, so no complex vacuum systems needed.
- ORC systems do not require 24/7 monitoring, and can be used in unmanned applications.

Figure A-34 shows that the installed power from ORC engines has increased exponentially worldwide over the past three decades.

Figure A-34: ORC Market Evolution

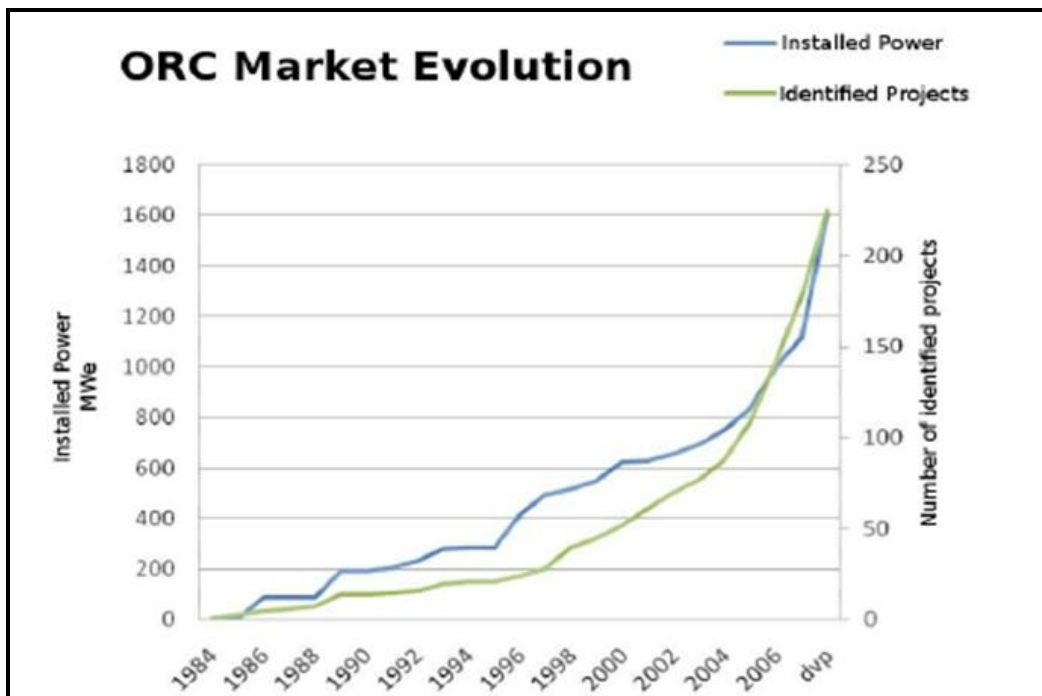

Source: Quoilin, Sylvain. Lemort, Vincent. "Technological and Economical Survey of Organic Rankine Cycle Systems". 2009. http://www.labohtap.ulg.ac.be/cmsms/uploads/File/ECEMEI_PaperULg_SQVL090407.pdf

A.6.2 Technology Operating Characteristics

The following section describes technical aspects of the ORC, including electrical efficiencies and emissions.

Electrical Efficiency

Electrical efficiency of these cycles is generally quite low; ranging from 10% to 20%.³⁶ The low efficiency is partly due to lower operating temperatures, and commensurately smaller net temperature change. Because ORC systems do not require high temperature differences, waste heat is a good source of heat input for ORC systems. Low grade waste heat can be found in many industrial processes and from the waste heat discharged from internal combustion engines. For the purposes of this cost-effectiveness study, the assumption is that the ORC system has an electrical efficiency of 15%.

Air Pollution Emissions

As ORC systems are closed-loop cycles and use waste heat, there is no fuel input. Consequently, ORC systems have no air pollution emissions.

Ramp Rates and Generator Profiles

Ramp rate for an ORC system is dependent on the source providing the waste heat. If a turbine was to be started from a cold condition without any warm up, the temperature strains set in the casing and rotors by a rapid heating will cause harm. Consequently, these units need to be slowly warmed up, by recommended ramp rates. According to Freepower, it takes about 40 minutes for their 120 kW system to reach full power from a cold start. This translates to a ramp rate of 2.5% of rated capacity per minute.

A.6.3 Current Technology Capital Costs

Pricing of ORC systems will typically range anywhere from \$2,000 to \$4,000/kW. The capital costs may be offset by the low maintenance costs, and low (or in some cases, zero) fuel costs.³⁷

Turboden was recently purchased by United Technologies Corporation (UTC). UTC gave costs for their Turboden TD6 and TD22 models as \$1,600,000 and \$2,800,000, respectively.

These costs included only the ORC units, and did not include any installation or related costs. UTC also indicated that the ORC unit is about 20-25% of the total cost of installation costs.

³⁶ Quoilin, Sylvain. Lemort, Vincent. "Technological and Economical Survey of Organic Rankine Cycle Systems". 2009. http://www.labohtap.ulg.ac.be/cmsms/uploads/File/ECEME1_PaperULg_SQVL090407.pdf

³⁷ "From Waste Heat to Power" <http://www.distributedenergy.com/january-february-2008/from-waste-heat-2.aspx>

Natural Gas - Waste Heat Recovery Applications

Waste heat in the hot exhaust of a gas turbine or reciprocating IC engine can be recovered through an ORC system. These systems will generally see a net heat rate (NHR) of around 7000 Btu/kWh. A 2008 report by Interstate Natural Gas Association of America (INGAA) compares total costs to generate power for a typical ORC compressor heat recovery system.³⁸ The capital cost breakdown can be seen below in Table A-40. Total installed capital costs include equipment, installation, and grid interconnection costs.

Table A-40: Estimated ORC Capital Costs

Capital Costs	
Installed Cost (\$/kW)	\$2,500
Load Factor (%)	95%
Annual Operating Hours	8,322
Equipment Life (years)	20
Cost of Capital (%)	8%
Capital Charge (\$/kWh)	\$0.0306

Source: INGAA. *Waste Energy Recovery Opportunities for Interstate Natural Gas Pipelines*.

INGAA also compared cost of power generation with the installed costs, as well as comparing cost of Power Generation against Compressor Operating Hours.³⁹ These graphs are shown in Figure A-35 and Figure A-36.

³⁸ Interstate Natural Gas Association of America (INGAA). “Waste Energy Recovery Opportunities for Interstate Natural Gas Pipelines.” <http://www.ingaa.org/File.aspx?id=6210>. 2008.

³⁹ This is based on a power price range of \$0.035/kWh-\$0.05/kWh for 2008 when the report was written.

Figure A-35: Cost to Generate Power as a Function of Capital Cost in \$/kW

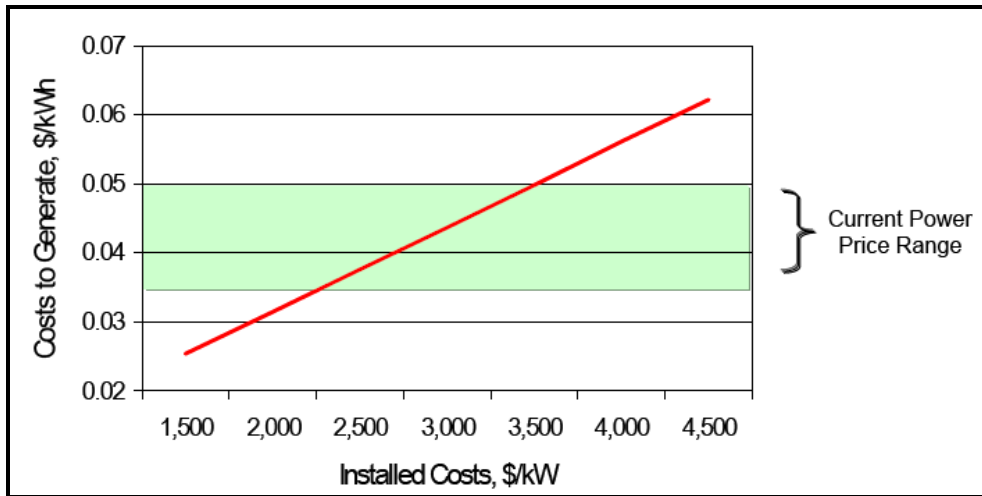
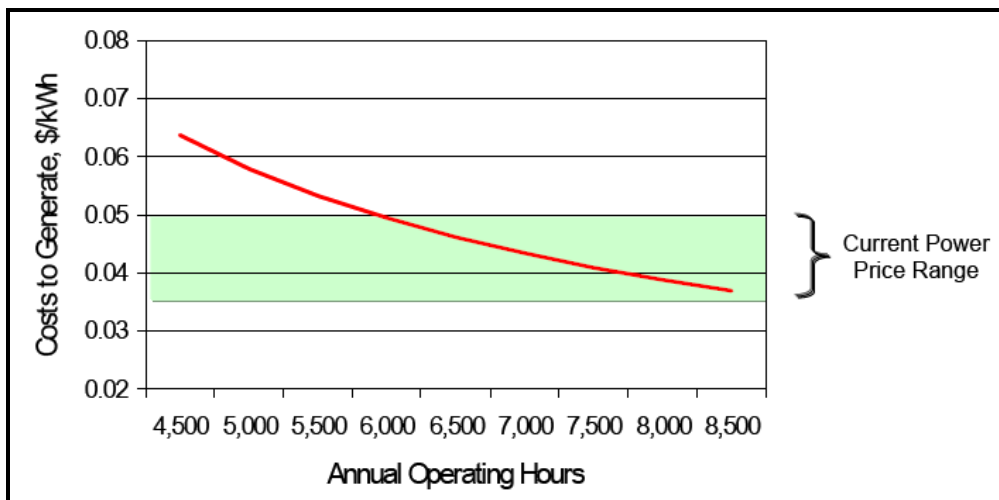

Figure A-36: Cost to Generate Power as a Function of Compressor Operating Hours



The two graphs show that the costs associated with generating power from heat recovery systems are affected by the load factor and capital costs. Figure A-35 shows that when using the February 2008 power price range, systems with a capital cost greater than \$3,500/kW are not economically viable, as the cost to generate power is greater than the cost to purchase power. The same can be said for systems whose annual operating hours are below 6,000, or a load factor of less than 68%, as the cost to generate power is not low enough to match the cost of purchasing power. For the purposes of this study, ORC system costs were assumed to be \$2,650/kW.

A.6.4 Technology Operating and Maintenance (O&M) Costs

INGAA also considered the operating costs that are associated with the power generation costs. The INGAA operating cost estimates are provided in Table A-41.

Table A-41: ORC System Operating Costs

Operating Costs	
Fuel Costs (\$/kWh)	\$0.000
Heat Costs (\$/kWh)	\$0.005
O&M Costs (\$/kWh)	\$0.002
Operating Costs to Generate Power (\$/kWh)	\$0.007

Source: INGAA. *Waste Energy Recovery Opportunities for Interstate Natural Gas Pipelines*.

No fuel is accounted in the case using waste heat from an industrial process. As ORC systems do not require a licensed steam plant operator for 24/7 monitoring, the operating costs are also relatively small compared to a typical steam plant.

The total operating costs provided matches to the annual maintenance costs provided by Freepower, a UK-based company that designs its ORCs for waste heat recovery. This company confirmed that for the first five years the price of O&M would be approximately \$0.007/kWh. An O&M cost of \$0.007/kWh was used for SGIPce modeling purposes.

A.6.5 Estimating Future Capital Costs

Figure A-37 shows a learning factor of 0.85 for ORC modules.⁴⁰ The learning curve was developed for ORC modules used in the European market. As production is limited to date, the learning curve is not steep. It is also important to recognize that an ORC system is a part of a larger power generation or industrial operation. Consequently, other factors must be taken into account when estimating future cost reductions. In addition, some ORC system components are mass-produced (i.e., pumps and heat exchangers), while other components are custom manufactured for specific applications.⁴¹

⁴⁰ “System Analysis for Progress and Innovation in Energy Technologies for Integrated Assessment,” http://www.eusustel.be/public/documents_public/WP/WP5/SAPIENTIA-Final%20Report.pdf. 2005.

⁴¹ Ibid.

Figure A-37: Learning Curve for ORC Modules (European Market)

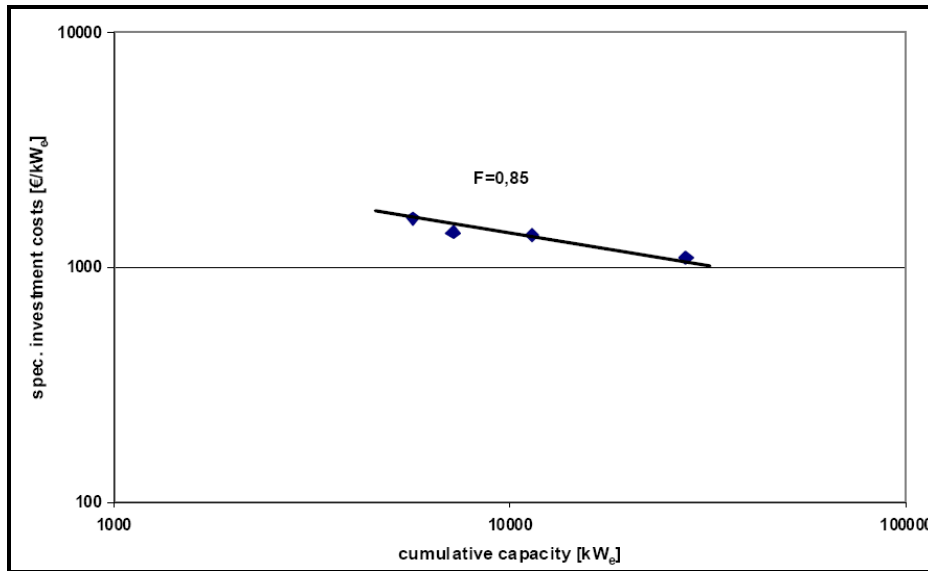

Figure A-34 was used to calculate the rate of growth assuming it applied over the past several years. The sales from 2000-2008 were used and a growth rate was calculated to be 11%. Then using the cumulative capacity from Figure A-37 the progress ratio was calculated, and came out to be 85.6%. The growth rate and progress ratio were used in the cost-effectiveness model to forecast the system prices until 2020.

A.7 Wind

A.7.1 Technology Summary

Wind turbines are typically two- or three-bladed fan-like structures that spin as the wind blows past the blades. A horizontal shaft at the center of the fan then turns a generator. The generator's electrical output, when conditioned properly, may be fed into the grid. Turbines usually are atop tall towers where wind speeds can be much higher than near the ground. Figure A-38 shows the primary components of a wind turbine that has motorized yaw control, the ability to be turned to face directly into or away from the wind as needed. The turbine also has low and high speed shafts connected through a gearbox.

Figure A-38: Wind Turbine Components



Source: REUK, "Look Inside A Commercial Wind Turbine,"

<http://www.reuk.co.uk/Look-Inside-a-Commercial-Wind-Turbine.htm>

Motorized yaw control is common in turbines above 50 kW. It is used to get the most energy from the wind by keeping the turbine facing directly into the wind as the wind shifts. It also is

used to turn the turbine away from the wind when less energy is wanted, for example during very high winds. Below 50 kW, wind turbines more commonly have yaw control by way of a “tail” that causes the rotor to be turned to face the wind directly. This tail may be automatically or manually controlled to adjust the yaw. This provides speed control of the rotor during very high winds or scheduled maintenance.

Gearboxes are substantial components of most wind turbines both in terms of weight and cost. Being in the nacelle atop the tower, their weight also influences tower design and cost. The gearbox, tower, and blades each represent about 10% of the total cost of an installed turbine. Direct-drive turbines without a gearbox are increasingly available, but in 2008 composed only 15% of the world market⁴² and are uncommon in North America. Constant and variable-speed rotors also exist but constant speed is more prevalent.

In addition to motorized yaw control, larger wind turbines generally have more advanced controls and features than smaller turbines. These include blade pitch control that allows the blades themselves to be twisted. Pitch control can increase electrical output during low wind speeds by effectively changing the aerodynamics of the blade. Larger turbines also have taller towers so the blades can always be in faster moving winds.

⁴² R. Poore and C. Walford, *Development of an Operations and Maintenance Cost Model to Identify Cost of Energy Savings for Low Wind Speed Turbines*, Global Energy Concepts, LLC Seattle, Washington, Subcontract Report, NREL/SR-500-40581, January 2008.

Figure A-39 shows the relative scale of several wind turbines, the smallest shown being 10 kW. The current industry standard for wind turbines over 100 kW is an upwind-facing, horizontal axis, three-bladed, blade pitch regulated unit housing a gearbox and an asynchronous generator all atop a tubular steel tower. Vertical axis turbines have not proved to be as cost-effective as horizontal axis turbines.

Figure A-39: Scale of Wind Turbines

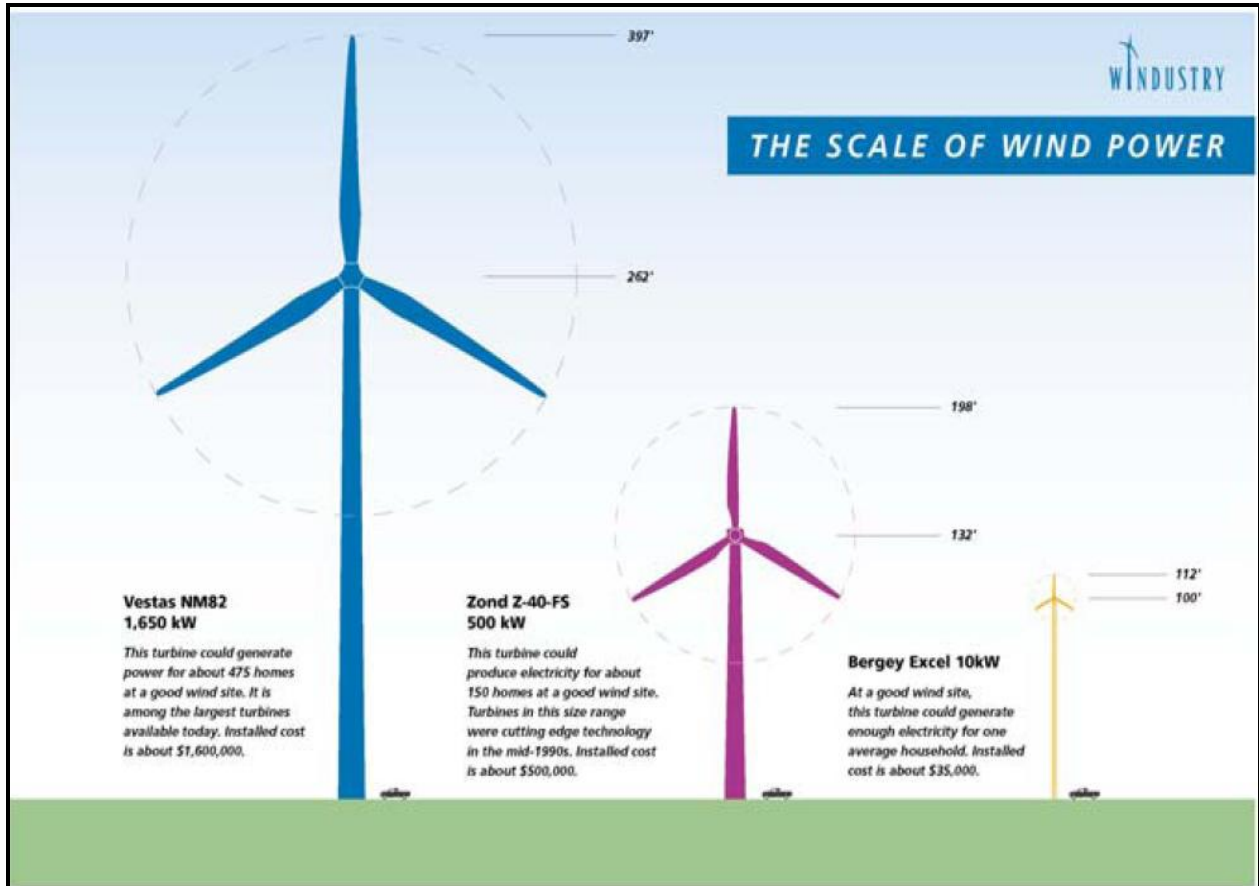

Source: Windustry, “The Scale of Wind Power,” <http://www.windustry.org/the-scale-of-modern-wind-turbines>.

Wind turbines may be installed individually or in groups. Groups of turbines installed in close proximity are referred to as “wind farms.” A wide range of economic and geographic factors influence decisions on the number and capacity of turbines to install. A single, large turbine can have the same rated generating capacity (kW or MW) of a wind farm composed of many smaller turbines.

The maximum capacity of turbines has grown dramatically in the last 20 years and has continued to increase; now exceeding 3 MW. The majority of new turbines are between 1 and 2.5 MW each. Table A-42 shows percentages by capacity range of annual turbines installations in the United States. Until recently turbines on the order of 1 MW had been considered ‘utility-scale’ or ‘wind farm-scale’ turbines, distinct from smaller, ‘farm-scale’ or ‘community-scale’ turbines. The distinction is becoming blurred, however, as both farmers and communities install individual turbines of 1 MW or more.

Table A-42: Size Distribution on Number of Turbines Installed in United States

	Years:	1998-99	2000-01	2002-03	2004-05	2006	2007	2008
	# MW:	1,018	1,758	2,125	2,776	2,454	5,249	8,558
	# turbines:	1,425	1,987	1,757	1,960	1,536	3,190	5,132
Turbine Size Range (MW)	0.00-0.5	1.3%	0.4%	0.5%	1.8%	0.7%	0.0%	0.5%
	0.51-1.0	98.5%	73.9%	43.4%	18.5%	10.7%	11.2%	10.1%
	1.01-1.5	0.0%	25.4%	43.5%	56.0%	54.0%	49.2%	53.4%
	1.51-2.0	0.3%	0.4%	12.5%	23.6%	18.4%	23.1%	16.1%
	2.01-2.5	0.0%	0.0%	0.0%	0.1%	16.2%	15.2%	17.5%
	2.51-3.0	0.0%	0.0%	0.1%	0.0%	0.0%	1.3%	2.4%

Source: R. Wiser and M. Bolinger, “Annual Report on U.S. Wind Power Installation, Cost, and Performance Trends 2008,” Lawrence Berkeley National Laboratory, 2009.

The American Wind Energy Association reports that eight of the 101 new wind power projects in 2009 used a single turbine. These single turbines ranged in size from 100 kW to 2 MW. Another 10 of the 2009 projects had fewer than 10 turbines but all the turbines were 1 MW or larger and some were 2.5 MW. “Farm” and “community” wind projects increasingly are using the very turbines previously thought of as “utility-scale.”

Many economic factors influence the decision to choose one turbine capacity over another, and whether or not to install single or multiple turbines. For example, offshore wind farms lean toward very large turbines due to the high cost of installing a single one, whatever its capacity might be. Likewise, smaller capacities might be chosen, and larger numbers of them installed, where there is ample land area but no cranes readily available to install very large capacity turbines. Indeed, offshore wind development has been limited in part by too few ship platforms with crane capacities available to install very large turbines. Meanwhile lower unit costs (\$/kW) of larger turbines may make them more attractive than smaller turbines, but their energy output may be greater than the owner can effectively use or sell. Still, units over 2 MW have been installed as stand-alone turbines.

Installation of turbines necessarily requires the output power be conditioned properly for its use or sale. In most cases alternating current (AC) power is required. When connected to an AC

utility grid, the output power also must be synchronized to the grid's AC signal and the interconnection must meet safety standards. Wind turbine manufacturers generally include the power conditioning electronics and interconnection equipment necessary for turbines or groups of turbines. Most turbine manufacturers are based in the United States or Europe. The major manufacturers are:

- Vestas
- Enercon
- NEG Micon
- GE Wind
- Gamesa
- SiemensWind Power (formerly Bonus)
- Nordex
- Furhländer
- REpower
- Mitsubishi Power Systems
- Suzlon Wind Energy
- Acciona WP
- Clipper

Past SGIP Applications

As of spring 2010, the SGIP had funded four wind projects with a total of six turbines. Project capacities ranged from 60 to 950 kW. Three projects have single turbines while the fourth has three turbines.

The capacities of these four wind projects may have been chosen based on program requirements that limit capacity. Until 2008, the program had limited project costs eligible for program funds to projects with a maximum net output of 1 MW at 30 mph wind speed. These limits may have discouraged some early program participants from installing turbines rated well over 1 MW. In 2008 this upper limit was raised to 3 MW, although the incentive amount stepped down above 1 MW.

The program always has further limited eligible project capacity to a minimum of 30 kW and a maximum of no more than twice the Host Customer's peak demand in the year prior to the application. This clearly limits the maximum capacity of an individual proposed turbine or project. The program lastly limits eligible project capacity to be in a combined system of no

more than 5 MW in capacity. These limits nevertheless allow for projects to have multiple turbines rated under 30 kW or even one turbine rated at 3 MW.

Technology Operating Characteristics

Wind turbines cannot be dispatched like conventional generation units. They also may have wide variations in power output. Their output depends on the local wind speed, air temperature, and air density, and so can be quite variable depending on location. This variability may have diurnal cycles, seasonal cycles, or both, again depending on location. Wind turbine manufacturers specify rated capacities of their turbine at specific atmospheric conditions; typically wind speeds over 30 miles per hour that are near ideal for continuous, high output. Turbines may generate above their rated capacities under different conditions, but generally they operate below their rated capacities.

The design of power conditioning equipment for turbines and wind farms must address the potential for variable output, particularly momentary lapses and surges in output. This is especially the case when interconnected to the grid. Depending upon their magnitudes, output lapses and surges may pose operational problems for transmission and distribution equipment and even for conventional generation units. If insufficient transmission capacity is available for power export, some wind farms cannot export all of their energy. Various forms of energy storage may be used to modulate turbine output. These include capacitive storage, beneficial for momentary variability and reactive power support to the grid, as well as pumped storage that permits the storage to be dispatched somewhat like conventional generation.

Proper selection of a site for a turbine depends largely on local atmospheric conditions. Locations with extreme wind gusts are avoided to reduce risk of potential damage to overstressed turbine components. Locations with high wind speeds during summer afternoon are preferable as their energy will have the most economic value if sold into the grid.

While without direct air pollutant emissions, wind turbines may pose environmental problems depending on location. Noise poses a problem near to and downwind of turbines. Visibility may be a problem. Site development may require new road building in areas with ecological sensitivities. Local and migratory bird and bat populations may be at risk while flying near turbines. The same is true for passing air traffic, and for ship traffic near offshore turbines. In a few cases radar interference has been a problem. These potential problems may raise costs related to obtaining local construction and operational permits, or may prevent installation altogether.

A.7.2 Current Technology Capital Costs

Capital Cost Elements

The capital cost of installation of a turbine can be broken down along lines of various cost and physical component groups. A turbine is sold as a unit rather than as components, but this breakdown allows consideration of which components show greatest potential for overall cost reduction. Table A-43 shows eight capital cost elements for installation of a turbine on the order of 1 MW. The costs are current estimates in 2010 dollars, normalized per kilowatt of rated turbine capacity to yield a unit cost per kW for turbines of various rated capacities. For turbines rated at less than 0.5 MW, current estimates generally will be higher as economies of scale are lower.

Table A-43: Wind Turbine Installation Element Unit Costs (\$/kW)

Capital Cost Element	Unit Cost	Percent
Blades	240	11%
Gearbox	240	11%
Generator	150	7%
Main frame, Hub, Nacelle cover, Spinner, nose cone	260	12%
Pitch mechanism & bearings, Bearings, Low speed shaft, Yaw drive & bearing, Hydraulic, Cooling system, Mech brake, HS cpling etc	170	8%
Variable speed electronic, Electrical Interface/Connections, Electrical connections, Control, Safety System, Condition Monitoring	520	24%
Tower, Foundations	300	14%
Assembly & Installation, Roads, Civil Work, Transportation, Engineering & Permits	310	14%
Total	2190	100%

Sources: *Revealing the Hidden Value that the Federal Investment Tax Credit and Treasury Cash Grant Provide To Community Wind Projects*, M. Bolinger, Lawrence Berkeley National Laboratory, 2010; *Wind Turbine Design Cost and Scaling Model*, L. Fingersh et al, National Renewable Energy Laboratory, 2006.

Table A-43 shows a total unit cost of \$2,190/kW. Of that, 24% originate from the cost element associated with power connections and control electronics. Costs within this element may be reduced by technological improvements and increased manufacturing volumes. This element then may benefit from a steeper learning curve and faster increases in manufacturing volumes. Tower and foundation costs meanwhile are very dependent on material costs, namely on steel

and concrete. Steeper learning curves and greater manufacturing volumes will do less to reduce those material costs.

Costs in SGIP

Cost data from SGIP reflect costs considered eligible under the program. The 2009 program handbook specifies these as eligible costs with regard to wind projects:

- Self-generation equipment capital cost.
- Engineering and design costs.
- Construction and installation costs. For Projects in which the generation equipment is part of a larger Project, only the construction and installation costs directly associated with the installation of the energy generating equipment are eligible.
- Engineering feasibility study costs.
- Interconnection costs, including:
 - Electric grid interconnection application fees.
 - Metering costs associated with interconnection.
 - Environmental and building permitting costs.
- Warranty and/or maintenance contract costs associated with eligible Project cost equipment (SGIP required a minimum 5-year warranty).
- Sales tax and use tax.
- On-site system measurement, monitoring and data acquisition equipment.
- Cost of capital included in the system price by the vendor, contractor or subcontractor (the entity that sells the system) is eligible if paid by the System Owner.

These eligible costs are very similar to those described in the literature and used in this section, except for the last item—the cost of capital. Such costs are not included in the non-SGIP costs described in this section, so they may appear lower than SGIP costs that had included cost of capital. It is not clear if any SGIP costs for wind turbines included any costs of capital.

The turbines already funded by SGIP include 20, 225, 750, and 950 kW units. The 950 kW turbine had the lowest unit cost of \$2,200/kW (2003\$). The others ranged from \$4,000/kW (2009\$) to \$5,600/kW (2007\$).

Of eight SGIP wind projects still in the pipe, three proposed capacities are between 1.5 and 2 MW and another three proposed are between 2.5 and 5 MW. No information is available on their proposed turbine sizes, but presumably these include several single-turbine systems. The proposed unit cost of these range from \$1,400 to \$7,500/kW (2009\$), with a median of

\$3,500/kW(2009\$). Curiously, the low and high unit costs are associated with the two smallest proposed capacities. The average cost excluding those two is still \$3,400/kW (2009\$).

Costs information from other sources

The costs shown in Table A-43 are based on a 2010 report specific to “community” wind projects with total capacity as low as 1.5 MW and as high as 10.5 MW. Those costs do not reflect the economies of scale possible in windfarm projects. As most new installed turbines are in wind farms, most available cost data reflect wind farm economies of scale. The author of that 2010 report is a co-author of a 2009 report that included Figure A-40 with costs in 2007 dollars. Figure A-40 represents windfarm costs primarily and includes a trendline suggesting 2010 turbine costs would be on the order of \$1,800/kW (2007\$).

Figure A-40: Trends in Installed Project and Turbine Unit Cost per Kilowatt of Rated Capacity

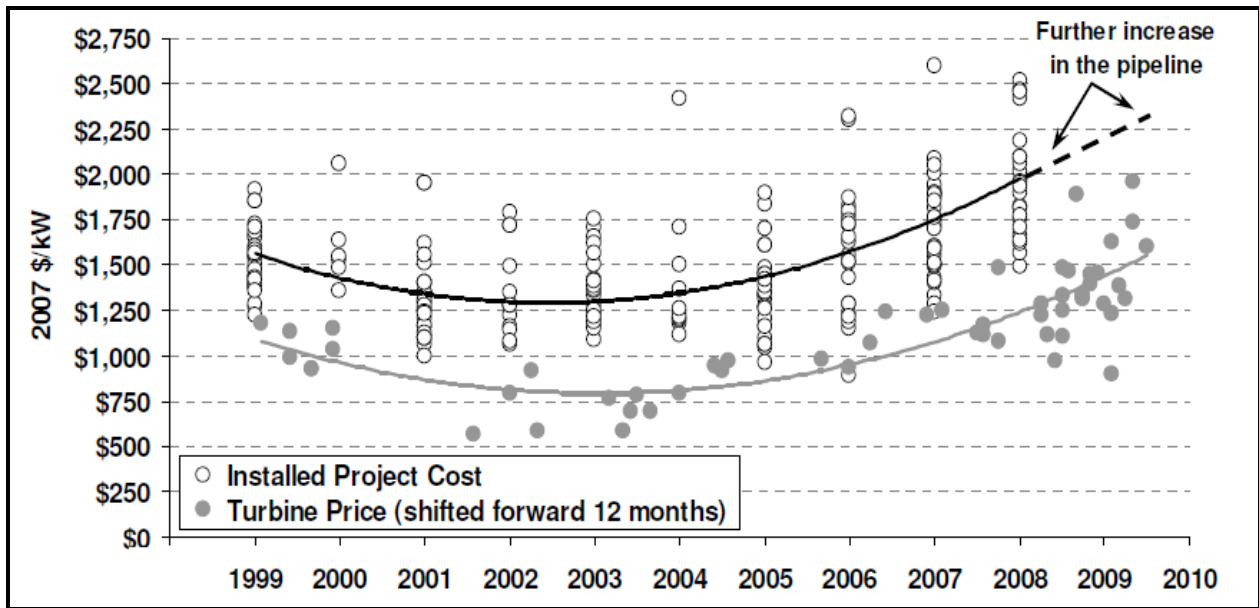

Source: *Wind Power Price Trends in the United States: Struggling to Remain Competitive in the Face of Strong Growth*, Mark Bolinger and Ryan Wiser, Lawrence Berkeley National Laboratory, 2009.

A 2007 study specific to ‘community’ wind projects suggests relative economies of scale between small and larger ‘community’ wind projects.⁴³ It gave examples of a 50 MW project costing \$1,628/kW (2007), while a 2 MW project was \$2,000/kW (2007). The smaller project’s

⁴³ WINDUSTRY’S Community Wind Toolbox, Chapter 8: Costs Associated with Community Wind Development, Windustry, 2007

unit costs were 23% greater than that of the larger project. Economies of scale thus may be seen in both individual turbine and total project capacities.

Conclusion on Capital Costs

Considering the project sizes SGIP currently encourages, a unit capital cost of \$2,190/kW (2009\$) is considered as the basis for evaluating wind turbine cost-effectiveness.

A.7.3 Technology Operating and Maintenance (O&M) Costs

Included Costs

Operations and maintenance (O&M) costs are ongoing costs after any wind turbine is installed. For community wind projects these annual costs typically average between 4 and 5% of total capital costs.⁴⁴ Land lease, property tax, and land rental costs may not apply if they are already otherwise paid for a facility that would install a turbine on its own property.

On-Going Operations

Wind turbines have no fuel costs but have many areas of fixed and variable operations and maintenance costs. A site or facility will have certain fixed annual costs whether or not there are multiple turbines or large or small turbines. These include salaries for operations and administration personnel, for site maintenance personnel, and for such equipment and supplies needed for daily operations. They also include insurance against major failures, and may include property taxes and rent or land lease costs as appropriate. They may also include set asides for major replacements would not be covered under warranty or insurance. These annual costs continue over the turbine's lifetime.

Variable costs arise from turbine maintenance and repair. These include labor, parts, and consumables (e.g., lubricants and filters). Variable costs will increase over the turbine's lifetime as more components require replacement as the turbine ages, and as manufacturers' warranties expire. Figure A-41 shows average fixed and variable O&M costs (2004 dollars) per turbine based on a 60 MW project composed of 40 turbines, each rated at 1.5 MW in capacity. This figure includes a levelized fix cost set aside for major component overhauls or replacements. Bollinger has estimated ongoing variable O&M costs for wind turbine systems at approximately \$0.0075/kWh.⁴⁵

⁴⁴ Northwest Sustainable Energy for Economic Development, *Community Wind: An Oregon Guidebook*, 2005.

⁴⁵ Bollinger, M., *Revealing the Hidden Value that the Federal Investment Tax Credit and Treasury Cash Grant Provide to Community Wind Projects*, LBNL, January 2010, pg. 21.

Figure A-41: Wind Turbine O&M Costs over Time

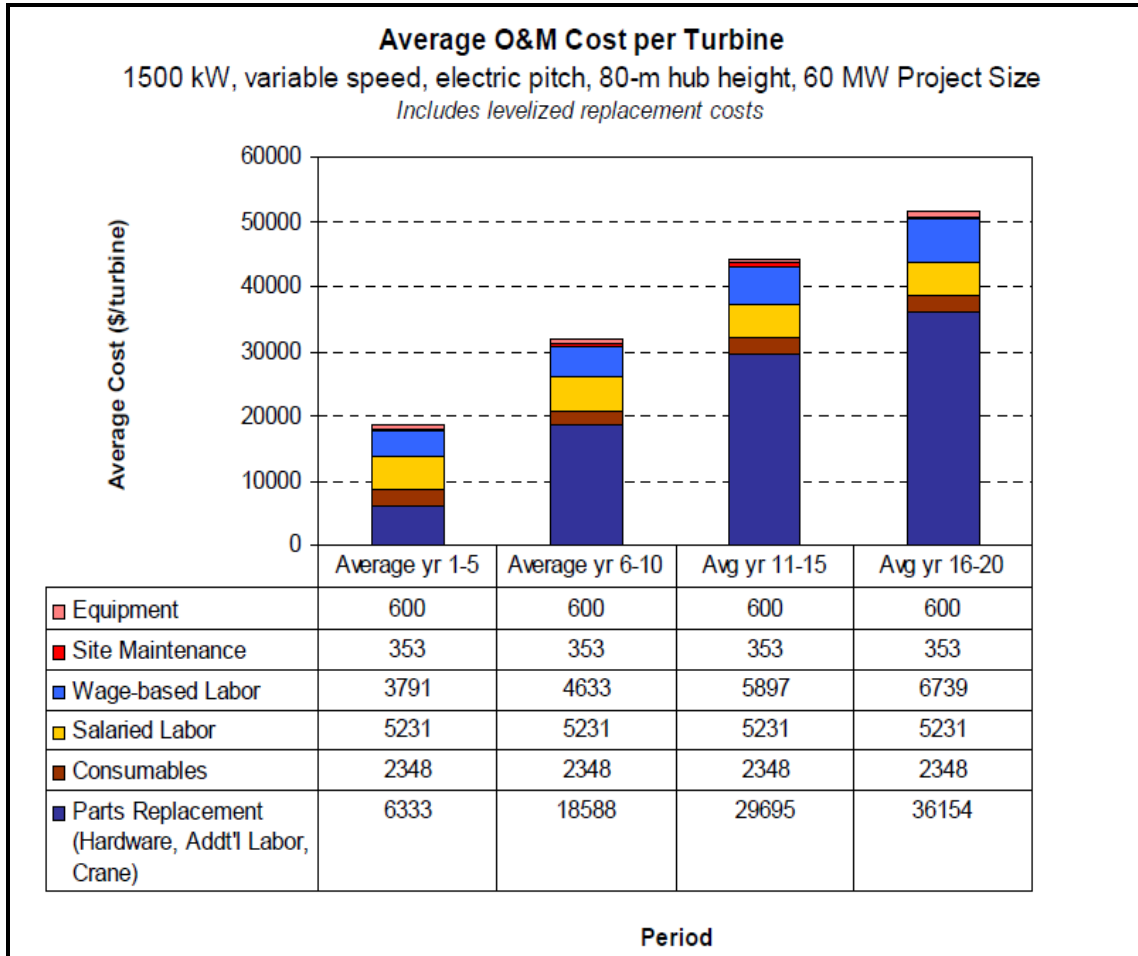

Source: Poore and Walford, 2008

Figure A-42 shows proportions of costs for parts and consumables over a turbine’s lifetime. This figure’s proportions also include set asides for major component overhauls or replacements.

Figure A-42: Proportions of Lifetime Parts Costs

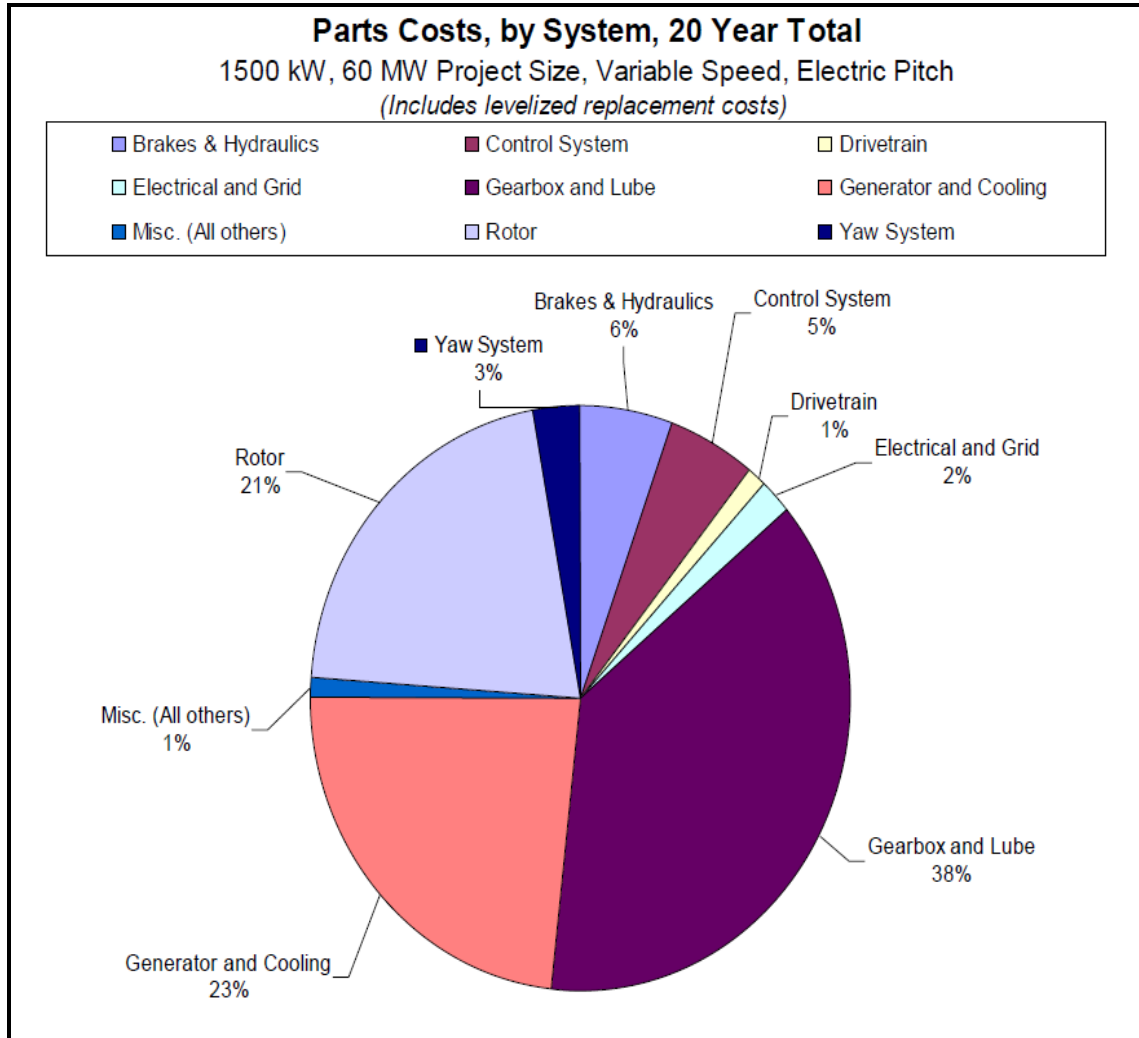

Source: Poore and Walford, 2008

Major On-Time Charges

Turbines occasionally can have major component failures requiring costly replacement. Those costs are not explicitly enumerated here. They are captured in terms of fixed O&M costs of warranty, insurance, and set-asides meant to cover costs for such replacements.

In instances where a turbine requires replacement of a major component in its lifetime, such as a blade or gearbox, a substantial part of the cost is the crane needed to remove and refit the

component. For larger turbines a nacelle-mounted crane may be an option from the manufacturer, but this may not serve for all component replacements. Taller towers and larger diameter rotors require longer and stronger cranes, raising crane rental costs. Remote or inaccessible turbine sites also raise crane rental costs as some cranes may require multiple truckloads just to be delivered to the site.

For the purposes of this study, O&M costs were assumed to be \$0.0075/kWh.

A.7.4 Estimating Future Capital Costs

Lower unit capital costs (\$ per kW of nameplate capacity) and O&M costs (\$/kWh generated) for turbines have arisen from improvements in both components and installations. Some of these improvements are due primarily to economies of scale of larger turbines capacities. Among these improvements are:

- taller towers resulting in increased hub height,
- larger rotor blades capturing more swept area,
- direct-drive (gearless) systems reducing material costs and weight,
- better foundations and site preparation reducing installation costs,
- better controls reducing stress on components to extend their lifetimes and increasing output under low-wind conditions,
- increased mechanical efficiency of generators increasing electrical output, and
- improved grid interconnections reducing associated equipment and installation costs.

Improvements will continue as research progresses in such important areas as blade aerodynamics, operating controls, drive trains, and grid interconnections. Increased manufacturing volumes also can lower unit capital and O&M costs. This process often is explained as following a learning curve whereby costs fall at some percentage with each doubling of production volume.

Impacts of Learning Curve on Capital Costs

Learning curves, and their complementary progress ratios, for wind turbines and wind energy have been estimated with values from 0.17 to 0.09.⁴⁶ Table A-44 lists a number of learning curve studies related to wind turbine, wind project, or wind energy costs.

⁴⁶ María Isabel Blanco, "The Economics of Wind Energy," *Renewable and Sustainable Energy Reviews* 13 (2009), 1372–1382.

Table A-44: Progress Ratios for Wind Energy Published in the Literature

Author	PR	Time frame	Region	n	R ²	Data qual.	Notes
Capacity of turbines / wind farms							
Mackay and Probert, 1998	85.7%	1981-1996	US	6.5	0.945	II	
(Durstewitz and Hoppe-Kilpper, 1999)	92%	1990-1998	Germany	5.6	0.949	I/II	
(Neij, 1999)	92%	1982-1997	Denmark	n.a.	n.a.	I/II	Danish-produced wind turbines
Seebregts et al., 1998	87% / 90%	n.a.	Denmark	n.a.	n.a.	II/III	
Lund, 1995	85%	n.a.	Denmark	n.a.	n.a.	II	
Neij et al., 2003	92-94%	1981-2000	4 countries ^o	n.a.	n.a.		Turbines produced per country
Milborrow, 2002	84.7%	n.a.	Danish manufacturers	7.1	n.a.	II	
Neij et al., 2003	92-94%	.	Several WT manufacturers	varying	0.74-0.99	I	Produced wind turbines in Denmark and Germany
Neij et al., 2003	89-96%	1981-2000	4 countries ^o	varying	0.85-0.94	I/II	Turbines installed in a country
Junginger et al. 2005	81-85%	1990-2001	Global	3.3/3.6	0.875-0.978	II	Price data from the UK and Spain combined with global installed capacity
Junginger et al. 2005	91-101%	1991-2001	Germany	7.3	0.80-0.995	I/II	Turbine prices / wind farm prices, two clear phases: 1991-1995 (PR 91%) and 1996-2001 (PR 101%)
Taylor et al., 2006	85%	1982-2000	Global	n.a.	n.a.	II	Price data from California combined with global installed capacity
Cost of electricity							
Neij et al., 2003	86-88%	1981-2000	4 countries	n.a.	0.87-0.97	I	specific electr. production by a country, x-axis measures cum cap. (MW) installed
Neij et al., 2003	83%	1981-2000	Denmark	n.a.	0.97	I	levelized electr. production by a country, x-axis measures cum cap. (MW) installed
Taylor et al. 2006	85.5%	1981-2002	California	n.a.	0.88	II	
± Data estimated from a figure, as exact numbers were not given. n Number of doublings of cumulative production on x-axis. R ² Correlation coefficient. n.a. Data not available. I cost/price data provided (and/or confirmed) by the producers covered II cost/price data collected from various sources (price lists, books, journals, press releases, interviews) III cost/price data (or progress ratio) being assumed by authors, i.e. not based on empirical data							

Source: *Technological learning in the energy sector*, M. Junginger et al, Netherlands Research Programme on Scientific Assessment and Policy Analysis for Climate Change, 2008.

Capital Equipment

Continued growth in turbine production volume and technological improvements can be expected to contribute to lower future costs, but other factors may keep costs rising. Since 2003 turbine costs have been rising, in part due to the law of supply and demand- demand has been outstripping supply. This has been just one contribution to higher turbine costs. Metals costs too have been rising rapidly since 2003. Turbines require large quantities of steel, especially for their towers and gearboxes. Copper is another big area of turbine costs as it is used in the generator and virtually every current-carrying part. Figure A-43 shows United States market copper costs have quintupled from 2001 to 2008 and low quality steel (ferrous scrap) prices have grown even more.

Figure A-43: Recent Trends in Cost of Metal Inputs to Industry

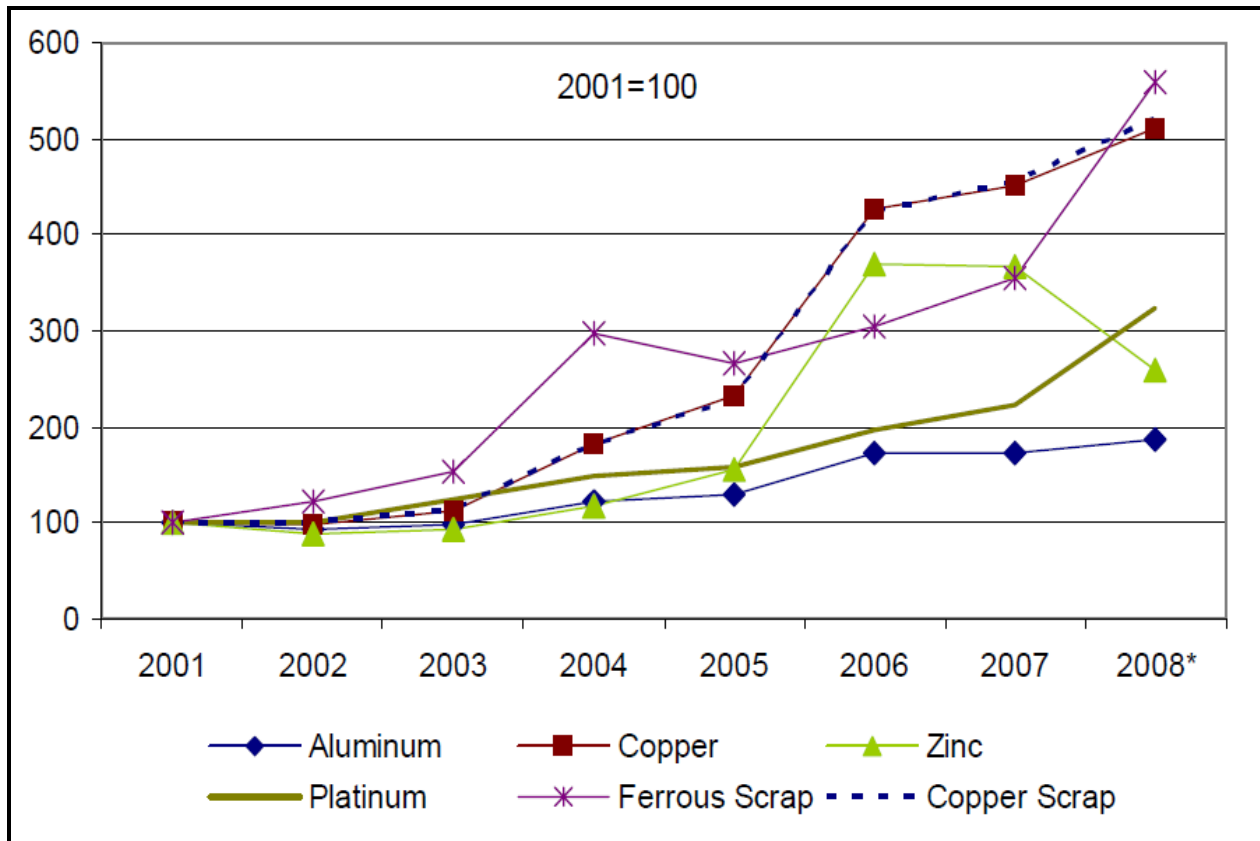

Source: *Minerals Price Increases and Volatility: Causes and Consequences*, Library of Congress Congressional Research Service, October 3, 2008.

Non-metallic materials have also seen sharp increases in prices. From 2004 to 2008 the cost of acrylonitrile, used to produce carbon fiber used in turbine blades, increased by 48%.⁴⁷ Concrete costs also have risen with energy costs generally due to the high embedded energy content of cement.

Metal price increases since 2001 have shown a clear change from long-term downward trends or stable costs. The prices of various qualities of steel prices have mostly doubled, but some have tripled or quadrupled between 2001 and 2008.⁴⁸ Meanwhile, the Consumer Price Index has only increased 24% from 2000 to 2008. If such trends continue turbine prices may not fall despite technological progress and greater volumes of manufacture.

A 2009 LBNL report describes substantial drops in energy and commodity prices in late 2008.⁴⁹ If this trend continues it may lower turbine material and installation costs. The weakness in the finance sector since 2008 also has led to a relative surplus of turbines, resulting in a buyer's market. There also is a growing market in refurbished wind turbines as older wind farms upgrade to newer and often larger units. Such cost reductions and better terms for buyers will put downward pressure on future project costs. Apart from these market factors, technology improvements and greater economies of scale also may put downward pressure on future capital and O&M costs.

⁴⁷ Ibid.

⁴⁸ Library of Congress Congressional Research Service, *Minerals Price Increases and Volatility: Causes and Consequences* (October 3, 2008).

⁴⁹ R.Wiser and M. Bolinger, Annual Report on U.S. Wind Power Installation, Cost, and Performance Trends: 2008, Lawrence Berkeley National Laboratory (2009).

A.8 Storage

A.8.1 Technology Summary

There are a variety of potential energy storage options for the electric sector, each with unique operational, performance, and cycling and durability characteristics. Despite the large anticipated need for energy storage solutions within the electric enterprise, very few grid-integrated storage installations are in actual operation in the United States today. This landscape is expected to change around 2011–2012, when a host of new storage options supported by more than \$250 million in U.S. stimulus funding begin to emerge and, in turn, catalyze a portfolio of new energy storage demonstrations. Such tests in real-world trials will provide needed data and information on the robustness of such systems, including performance and durability, cycle life costs, and risks.

Each type of energy storage technology has its own capital cost and operating cost parameters. Technology costs and application values are very sensitive to the configuration of the storage system both in terms of discharge capacity (MW) and energy storage capacity (MWh).

A summary of energy storage technologies is presented in Figure A-44. There are four broad categories of energy storage technologies:

1. Ultra-fast response – short duration: Flywheels and super capacitors can respond in less than one second but are limited in the amount of energy that can be stored.
2. Fast response – medium duration: Li-ion and lead acid batteries can respond in several seconds or less and are generally configured to deliver energy from 1-4 hours.
3. Medium response – long duration: Flow batteries can generally store greater amounts of energy, 6-10 hours or more. They can also respond relatively quickly, but take some time to switch from charging to discharging mode.
4. Bulk Storage – CAES and pumped hydro are large, utility-scale technologies providing 10 or more hours of energy storage.

Figure A-44: Energy Storage Technology Landscape

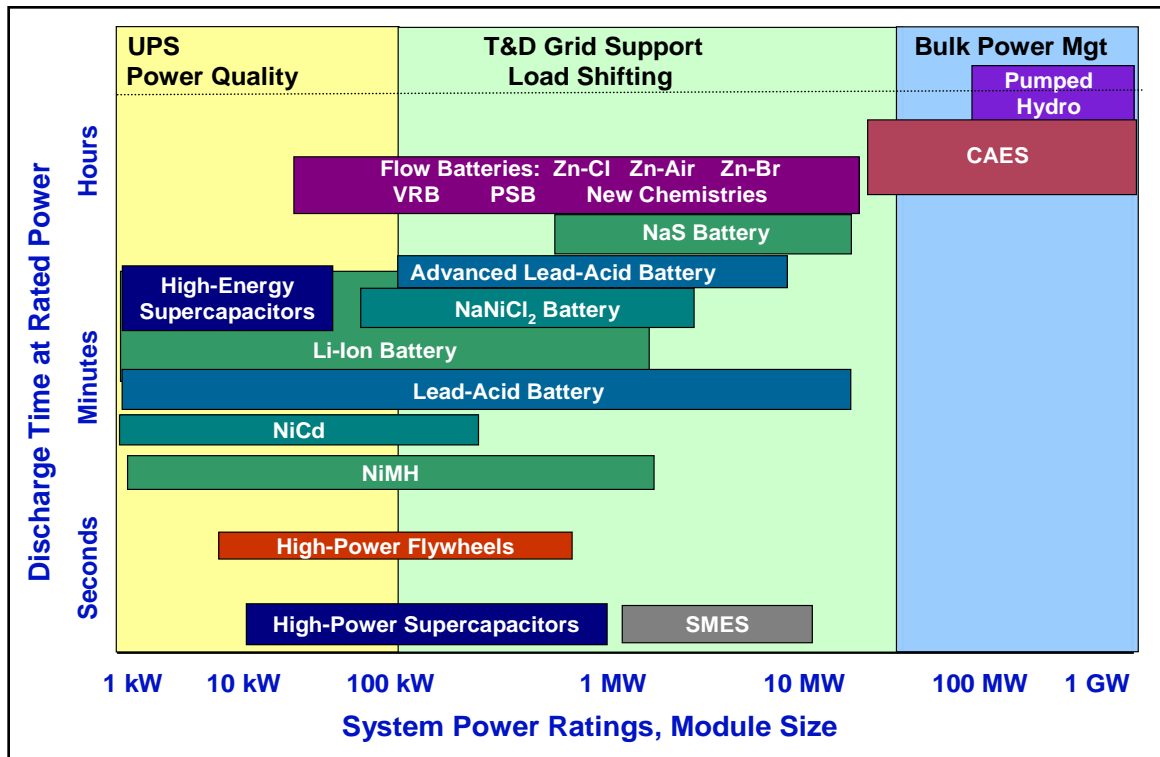

Source: *Electric Energy Storage Technology Options: A White Paper Primer on Applications, Costs and Benefits*. EPRI, Palo Alto, CA, 2010. 1020676.

A.8.2 Current Technology Capital Costs

Cost and performance specifications for all technologies, including Li-ion are extremely uncertain. EPRI research indicates that in the near-term some storage technology costs could decrease significantly as the electric vehicle industry ramps up battery production. Advanced lead-acid batteries, Zn/Br flow batteries, and emerging Zn/air and Fe/Cr were generally found to have potential for low capital expenditure and the smallest gaps to support the energy storage business case for battery technologies. Li-ion batteries, with the most significant cost reductions anticipated via increasing production capacity, could potentially prove competitive for a number of applications in the near and longer term for energy durations less than four hours.

Two sizes of Li-ion, 1 MW and 25 kW, were modeled for this report. Li-ion was chosen because the technology is used in many smaller scale commercial applications today and is receiving significant investment in R&D and manufacturing capacity for electric vehicles and other markets.

The costs and performance specifications for Li-ion were taken from early drafts of the *Electricity Energy Storage Technology Options White Paper* published by EPRI in December

2010. The Li-ion large system is assumed to have a cost of \$800 per *installed* kWh. Accounting for the 20% minimum state of charge, the cost increased to \$1,000 per *effective* kWh. The costs for the Li-ion small system are assumed to be higher at \$1,290 and \$1,613 per installed and effective kWh respectively.

Table A-45: Li-ion Capital Costs

Technology Option	Capacity (kWh)	Power (kW)	Duration (hrs)	% Efficiency (total cycles)	Cycle Life	Minimum State of Charge	Cost (\$/kW)	Cost* (\$/kW-h)
Li-ion - Large	4,000	1,000	4	80%	5,000	20%	\$4,000	\$1,000
Li-ion - Small	100	25	4	80%	5,000	20%	\$6,450	\$1,613

* Costs expressed in \$ per *effective* kWh, accounting for 20% minimum state of charge.

A.8.3 Technology Operating and Maintenance (O&M) Costs

Anticipated O&M costs for energy storage technologies are even more speculative than the capital costs, given limited operational experience to date for most technologies. For Li-ion it was assumed that the storage capacity declined by 20% over the life of the battery. To maintain a consistent level of output, approximately 8% of the battery cells are modeled as being replaced each year. This results in an annual O&M cost of \$64 and \$103 per kWh installed in 2009.

A.8.4 Estimating Future Capital Costs

As with residential fuel cell technology, limited information is available on historical system costs. Because Li-ion is a somewhat more mature technology than fuel cells, a progress ratio of 90% was used (as compared to 80% for fuel cells). The installed MW and costs in \$ per kWh installed are shown in Figure A-45. The installed capacity of ~20 MW in 2010 is assumed to double every five years.

Figure A-45: Installed Capacity and Capital Costs for Li-ion

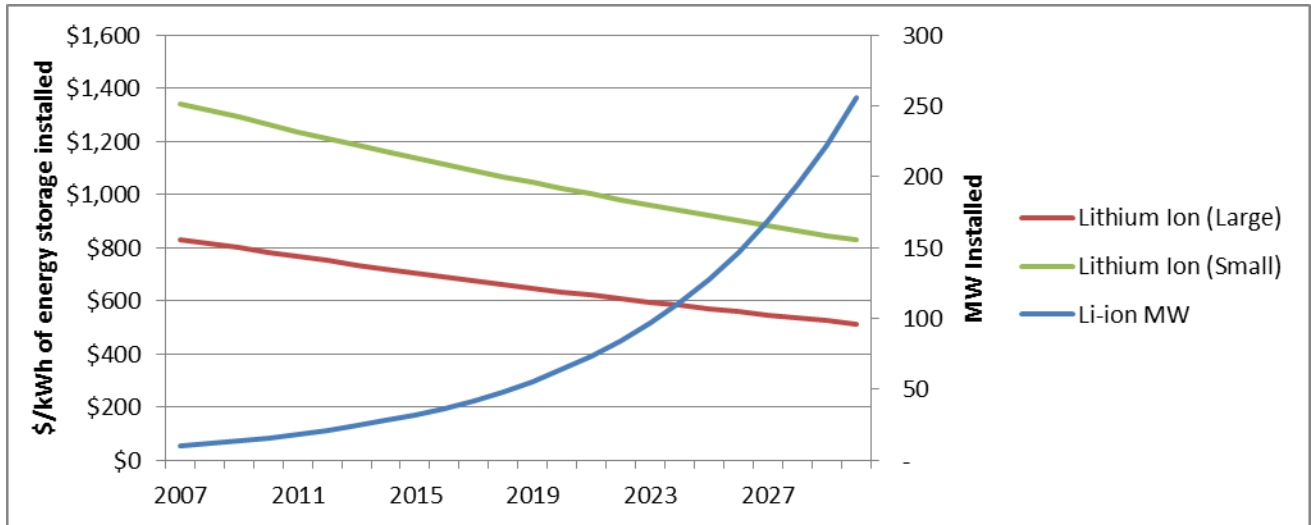

A.8.5 Storage Dispatch

Three storage applications were modeled: peak shifting, distribution deferral, and energy arbitrage. For each application the battery was assumed to charge and discharge once a day in normal operation throughout the year. The battery is charged over five hours in the lowest-cost Off-Peak hours and discharged for four hours On-Peak during the highest priced hours. The one-hour difference is due to the 20% round-trip efficiency loss. For the peak shifting application, the battery is not discharged and kept full for the top 150 system load hours, and for a window of four hours before and after. For distribution deferral, the battery is similarly kept full for the 150 hours with the highest temperatures. In practice, the three scenarios produced very similar cost-effectiveness results, so the results for the energy arbitrage application were used.

Appendix B

SGIPce User Guide



Knowledge to Shape Your Future

Electric | Gas | Water
information collection, analysis and application

CPUC Self-Generation Incentive Program

SGIPce User Guide

Prepared by:

Itron, Inc.
11236 El Camino Real
San Diego, CA 92130

January 31, 2011

Table of Contents

1 SGIPce User Guide Overview	1-1
2 Quick Start Guide	2-1
2.1 Overview.....	2-1
2.2 Installation.....	2-1
2.2.1 Hardware and Software Requirements.....	2-1
2.2.2 Installing the Workbooks.....	2-1
2.2.3 Trusted Security Settings.....	2-2
2.3 Using the System.....	2-2
2.3.1 Introduction.....	2-2
2.3.2 Starting the System.....	2-2
2.3.3 Setting up a Run.....	2-4
2.3.4 What Happens When You Press a Batch Processing Button?.....	2-10
2.3.5 Where are the Results?.....	2-11
2.3.6 Error Log.....	2-11
2.3.7 Calculation Engine.....	2-13
2.3.8 Results Workbook.....	2-20
2.4 Additional Workbooks.....	2-23
3 Overview of SGIPce	3-1
3.1 Overview.....	3-1
3.2 The SGIPce System.....	3-1
3.2.1 Model Objectives.....	3-1
3.2.2 Model Outputs and Results.....	3-2
3.2.3 Model Structure.....	3-3
3.2.4 Batch Processing.....	3-8
4 Run Processor	4-1
4.1 Overview.....	4-1
4.2 SGIPce Opening Screen.....	4-2
4.2.1 Global Assumptions Table.....	4-2
4.2.2 Technology Definitions Table.....	4-5
4.2.3 The Button Box.....	4-10
4.3 Error List Worksheet.....	4-12
4.4 Lookup Table.....	4-14
4.5 Finally.....	4-14
5 Calculation Engine	5-1
5.1 Overview.....	5-1
5.2 SGIPce Calculation Engine.....	5-1
5.2.1 Calculation Engine, Tab by Tab.....	5-2

6 Technology Workbooks.....	6-1
6.1 Overview.....	6-1
6.2 Technology Workbooks Described	6-1
6.2.1 List of Workbooks.....	6-1
6.2.2 Tabs in the Technology Workbooks.....	6-3
7 Other Input Workbooks	7-1
7.1 Overview.....	7-1
7.2 List of Other Input Workbooks	7-1
7.3 Other Input Workbook Descriptions	7-2
7.3.1 Adoptions Workbook.....	7-2
7.3.2 Avoided Cost.....	7-5
7.3.3 Global.....	7-7
7.3.4 Rates.....	7-9
8 Results Workbooks.....	8-1
8.1 Overview.....	8-1
8.2 Results Worksheets.....	8-1
8.2.1 Summary and Input Worksheets.....	8-1
8.2.2 Technology Worksheets.....	8-2
9 How To Change It.....	9-1
9.1 Introduction.....	9-1
9.2 Parameters in the Technology Definitions Table	9-1
9.2.1 Technology Definitions List.....	9-2
9.2.2 Fields in the Technology Definition List.....	9-3
9.3 Manual Changes to Inputs.....	9-7
9.3.1 On-site Biogas (OSBG).....	9-7
9.3.2 Capital Costs.....	9-8
9.3.3 O&M Costs.....	9-9
9.3.4 Directed Bio Gas Adder.....	9-9
9.4 Finally	9-10

List of Figures

Figure 2-1: SGIPce Directory Structure.....2-3

Figure 2-2: SGIPce Control Worksheet.....2-3

Figure 2-3: Global Assumptions2-4

Figure 2-4: Technology Definitions.....2-6

Figure 2-5: Technology Definitions (continued).....2-8

Figure 2-6: SGIPce Buttons2-8

Figure 2-7: Error Log.....2-11

Figure 2-8: Calculation Engine Cover Sheet2-13

Figure 2-9: Results Page.....2-14

Figure 2-10: LCOE ProForma Sheet.....2-15

Figure 2-11: Annual Input Table.....2-16

Figure 2-12: Technology-Level Constants.....2-17

Figure 2-13: Technology-Level Annual Inputs.....2-18

Figure 2-14: Global Finance Inputs2-19

Figure 2-15: Results Cover2-20

Figure 2-16: Results Adoption.....2-21

Figure 2-17: Summary Stats Per Unit.....2-22

Figure 2-18: Summary Stats Total2-22

Figure 3-1: Climate Regions in California.....3-3

Figure 3-2: SGIPce Model Flow3-4

Figure 4-1: SGIPce Opening Screen.....4-1

Figure 4-2: Global Assumptions4-2

Figure 4-3: Technology Definitions Table.....4-5

Figure 4-4: The Button Box 4-10

Figure 5-1: Cover Tab 5-2

Figure 5-2: Results Tab 5-3

Figure 5-3: Results Tab (continued) 5-4

Figure 5-4: Results Tab (continued) 5-4

Figure 5-5: Results Tab (continued) 5-5

Figure 5-6: Results Tab (continued) 5-5

Figure 5-7: Results Tab (continued) 5-5

Figure 5-8: Benefit/Cost Ratio Graphic 5-6

Figure 5-9: Benefit/Cost Test Tables 5-7

Figure 5-10: Benefit/Cost Test Chart 5-7

Figure 5-11: LCOE ProForma Tab 5-8

Figure 5-12: Input Tab 5-9

Figure 5-13: Technology Tab 5-10

Figure 5-14: Annual Inputs 5-10

Figure 5-15: Annual Inputs (continued) 5-11

Figure 5-16: Annual Inputs (continued) 5-11

Figure 5-17: Annual Inputs (continued) 5-11

Figure 5-18: Finance Tab (Global Values) 5-12

Figure 5-19: Finance Tab (Annual Values) 5-12

Figure 6-1: Constants Tab 6-3

Figure 6-2: Annual Inputs 6-4

Figure 6-3: Annual Inputs (continued) 6-4

Figure 6-4: Technology Production 6-5

Figure 6-5: Production Curves 6-6

Figure 6-6: Distribution Table6-6

Figure 7-1: Technology List.....7-3

Figure 7-2: Adoptions Table7-3

Figure 7-3: Adoption Calculations Tab7-4

Figure 7-4: User Inputs.....7-5

Figure 7-5: Adoptions Used by the System7-5

Figure 7-6: Electric Avoided Cost.....7-6

Figure 7-7: Gas Avoided Cost.....7-6

Figure 7-8: Global Financing.....7-8

Figure 7-9: Global Inputs.....7-9

Figure 7-10: Global Constants7-9

Figure 7-11: Electric Rate Calculation Worksheet.....7-10

Figure 7-12: Electric Rate Definition Worksheet.....7-11

Figure 7-13: Gas Transportation Summary Worksheet.....7-12

Figure 7-14: Gas Transportation CalcsSeparate Worksheet.....7-12

Figure 7-15: Gas Transportation UseinCECalcEng Worksheet.....7-13

Figure 7-16: Gas Transportation Utility Rate Definition Example7-14

Figure 7-17: Gas Transportation Fuel Prices Worksheet7-15

Figure 7-18: Electric TOU Rate Calculation Example.....7-16

Figure 7-19: Electric Tiered Rate Calculation Example7-16

Figure 7-20: Production Curve7-17

Figure 7-21: Electric Rate Definition.....7-18

Figure 7-22: Gas Rate Calculation Worksheet7-18

Figure 7-23: Gas Rate Definition Example7-19

Figure 8-1: Cover Tab8-2

Figure 8-2: Adoptions Tab.....8-3

Figure 8-3: Technology Level Summary Data8-4

Figure 8-4: Overall Summary Data.....8-4

Figure 8-5: Graphical View of Installed Capacity (MW)8-5

Figure 8-6: Graphical View of Benefit/Cost Ratios8-6

Figure 8-7: Template Worksheet.....8-7

Figure 8-8: Technology Combination Results Workbook Example8-8

List of Tables

Table 6-1: List of Technology Workbooks6-2

Table 7-1: List of Adoption, Rates, and Avoided Cost Workbooks7-1

1

SGIPce User Guide Overview

The SGIPce User Guide is designed to be a detailed look at how to use the system. The SGIPce system was designed to estimate the cost-effectiveness of distributed generation (DG) systems over time. The system incorporates the assumption of market transformation, allowing the user to define the likely future path of the DG system installation costs. It also allows the user to select various technologies of interest and calculate their cost-effectiveness as a group and store the results for review and further analysis.

Development of the software began with the Energy and Environmental Economics (E3) CSI ProForma Levelized Cost of Energy (LCOE) worksheet. The E3 model is designed to calculate the levelized cost of energy for PV systems. The E3 model was modified to enable the analysis of Combined Heat and Power (CHP), storage, and wind systems to provide a model capable of analyzing the cost-effectiveness of multiple types of DG technologies. The SGIPce system was built by surrounding the modified LCOE worksheet with a set of input worksheets and workbooks used to provide inputs and to store outputs used and generated by the DG cost-effectiveness system. The primary outputs of the SGIPce system are the program and measure level cost-effectiveness tests.

The purpose of the User Guide is to present details about the components of the system. The User Guide documents the input workbooks, it includes information about the engine that controls the model runs, and it provides a discussion of the results that are generated and stored by the system.

A Quick Start Guide has been developed to aid the user in getting the system up and running. This guide is included in this document. It provides instructions on how to install the system and how to setup Excel 2007 for first use. These instructions must be followed for the system to operate correctly. After the Quick Start Guide the user will find a more detailed description of the system's components.

2

Quick Start Guide

2.1 Overview

The Quick Start Guide is designed to get the user up and running quickly. Instructions are included on the following:

- How and where to copy the workbooks,
- How to start the system,
- What can be changed to do a batch run,
- What buttons to push to start the batch run,
- Where output is stored, and
- Where to view results.

This document is designed to show the user how to get the system up and running. This guide is not designed to be a complete guide to manually changing inputs for various scenarios.

2.2 Installation

2.2.1 Hardware and Software Requirements

To run the SGIPce software the computer must be running Microsoft Excel 2007. As for hardware requirements, the system will utilize as much memory as the computer makes available to it and the amount of hard drive space will be determined by the number of runs the user chooses to make.

2.2.2 Installing the Workbooks

The SGIPce system is a collection of workbooks. The distribution media includes all files needed to run the system. The contents of the SGIPce directory must be copied from the distribution media onto the user's hard drive. Once copied, follow the instructions, described below, to set up this directory as a Trusted Directory so that the SGIPce macros will run on the computer. When this is complete, you are ready to start the system.

2.2.3 Trusted Security Settings

Excel has a security system that protects the user from undesirable access to their systems using Visual Basic (VBA). The following steps must be performed to allow VBA to work on the system.

- Open Excel and press the Office button, top left.
- Press the *Excel Options* button, bottom right.
- Select *Trust Center*.
- Press the button called *Trust Center Settings...*
- Select *Trusted Locations*.
- Make sure the *Allow Trusted Locations...* option is checked.
- Press *Add New Location...*
- Browse to the path where *SGIPce.exe* is located and press *Enter*.
- Check the checkbox that says *Subfolders of the location are also trusted*.
- Press *Ok*.
- Press *Ok*.
- Press *Ok*.
- Reopen *SGIPce.xlsm*.

With these settings changed, the system will be able to run the VBA batch processor.

2.3 Using the System

2.3.1 Introduction

The collection of workbooks that you have installed on your system includes SGIPce, the calculation engine, an Inputs folder with the various input workbooks, and a Results folder with a results template. This subsection will focus on the SGIPce file and using the file to run the DG cost-effectiveness model.

2.3.2 Starting the System

The system is initiated when the user opens *SGIPce.xlsm* in Excel 2007. This file can be found in the top-most directory on the drive where the directory was copied from the CD. An example

of the directory can be found in Figure 2-1.¹ This workbook opens to the controlling worksheet of the system. Further discussion about this screen follows.

Figure 2-1: SGIPce Directory Structure

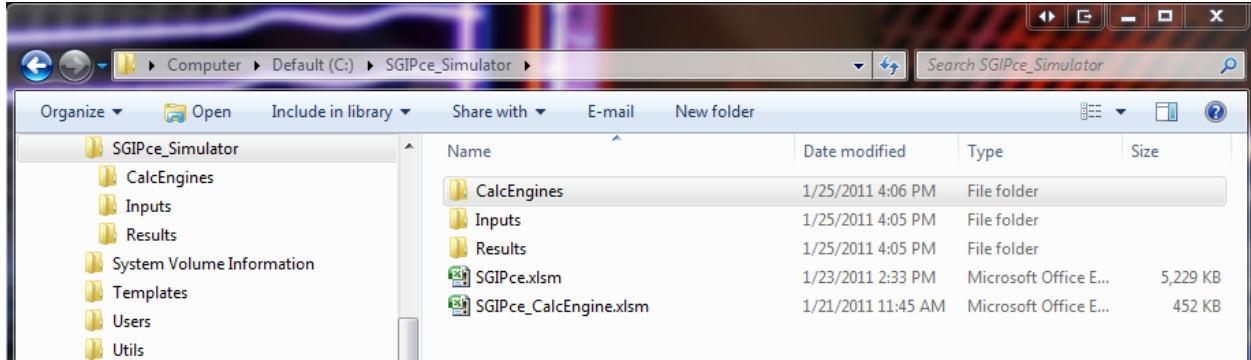

An example of the SGIPce Control worksheet is presented in Figure 2-2. This worksheet is used to set up the technologies to be run, names the iteration being run, and starts the Calculation Engine to perform the batch run. This is the worksheet that the user must first set up to select the technologies, sector, fuel used, utility and utility rate, climate region, financing, and rebate type.

Figure 2-2: SGIPce Control Worksheet

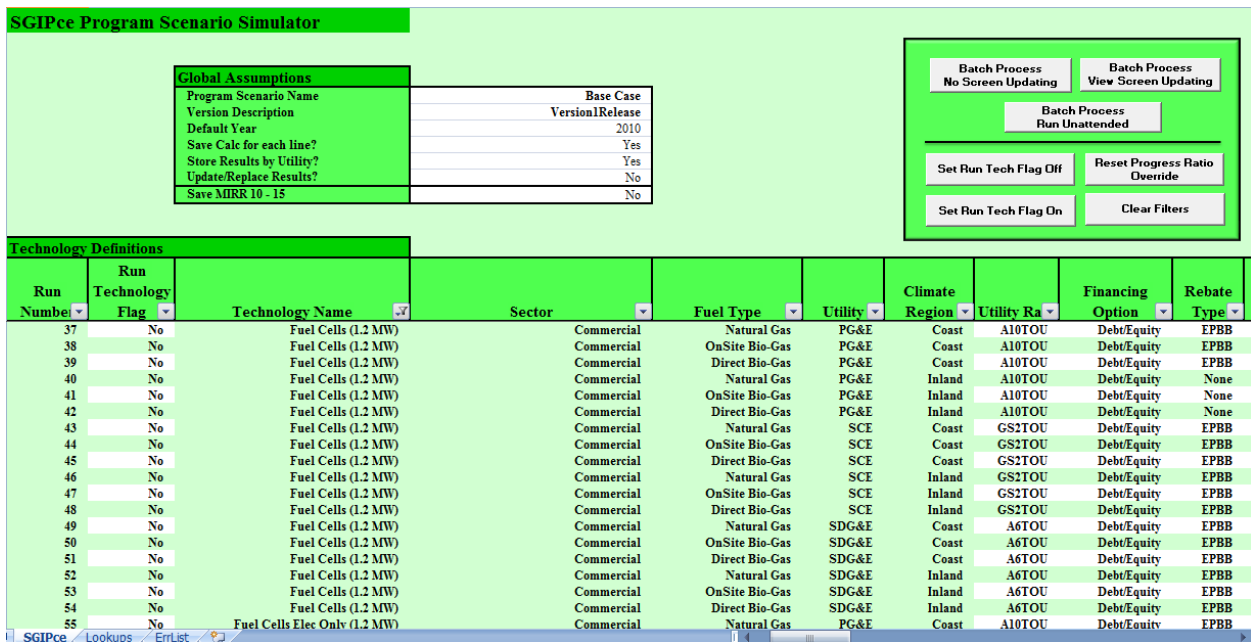

¹ Note: the *CalcEngines* subdirectory shown in Figure 2-1 will be created by the system the first time the batch processor is run with the save calculations options selected.

2.3.3 Setting up a Run

Setting up a batch run is done in the SGIPce workbook. There are three areas on the control worksheet:

- Global Assumptions: Input text boxes used to describe the run.
- Technology Definitions: Technology list.
- Buttons: Used to start the run and to clear or set the run flag.

Global Assumptions

The Global Assumptions are used to define the batch run. When a batch run is executed, the program will create aggregated results for the entire list of selected technologies and individual technology calculation workbooks for each selected technology. The aggregated results are stored in the Results directory while the individual technology workbooks are stored in the CalcEngines directory in their own subdirectory. The Global Assumptions and their uses are described below.

Figure 2-3: Global Assumptions

Global Assumptions	
Program Scenario Name	Base Case
Version Description	Version1Release
Default Year	2010
Save Calc for each line?	Yes
Store Results by Utility?	Yes
Update/Replace Results?	No
Save MIRR 10 - 15	No

- **Program Scenario Name:** A drop-down that is used to identify the run. The Program Scenario Name is used when saving the Calculation Engine and the Results workbook.
 - **Base Case:** The default program scenario name with input values at their base level.
 - **Greenhouse Gas:** The greenhouse gas scenario with predefined changes applied to the inputs representing price changes due to more stringent regulation of *Greenhouse Gas*.
- **Version Description:** A user-defined name used to identify the run when saving the Calculation Engine and the Results workbook.
 - To preserve results from previous runs the user should change the value of this field. A new folder for the calculation engines will be created using the new name and a new Results workbook will also be created.

- If you choose to add or correct technology results in a previously defined version then use the same name as before and set *Update/Replace Results?* to *Yes*. See below for more information on this.
- **Default Year:** The default year for the technology calculation engines. The year for which results will be presented in the LCOE tab of the technology calculation engines and in the Current Year column in the Results tab.
 - The default year can also be changed in the Calculation Engine following the batch run to view results for each period when a Debt/Equity run has been performed.
 - If *Save MIRR...* is set to *Yes*, then the LCOE worksheet is set to the default year before it calculates the values of the rebates that result in the Modified Internal Rates of Return (MIRR) of 10 through 15. Using a different default year will calculate different values for these six rates.
- **Save Calc for each line?:** If the user chooses *Yes* a copy of the calculation workbook for each technology in the run will be placed in a subdirectory within the CalcEngines directory.
 - If the user chooses *Yes*, all inputs used to calculate the results for each technology are stored as part of the Calculation Engine workbook. The name of the individual Calculation Engine workbooks includes identifiers indicating the technology and other characteristics used for that run.
 - If the user chooses *No*, a calculation workbook for the technologies in the run will not be created. A Results workbook for aggregated run will only be created.
- **Store Results by Utility?:** If the user chooses *Yes*, a separate Results workbook will be created for each utility. If this flag is set to *No*, only one Results workbook will be created and the results for all utilities will be placed in one workbook with the suffix *All*.
- **Update/Replace Results:** If the user chooses *Yes*, the system looks for a Results workbook with the current user defined run name to update the data that the user chose to update and to add data to a portfolio that was previously omitted.
 - If *Yes* and the system finds an existing workbook with the current name it will update the results for any technology combination found in the workbook and add any new technology combinations that have been defined. Also under this option, if the technology combination exists in the workbook but not in the current run, it will not delete the pre-existing technology combinations.
 - If *No* the system will write a completely new Results workbook, overwriting the pre-existing workbook.

- **Save MIRR 10-15:** Tells the system whether or not the user wants to run the code that finds the rebate in the Default Year that generates a Modified Internal Rate of Return (MIRR) at 10%, 11%, 12%, 13%, 14% & 15%.
 - A new version of the Calculation Engine is saved to the drive for each of the six values.
 - *Note: This can take some time so it is suggested that this be done for a small set of technologies first to understand the workbooks that are saved and how they might be used.*

Technology Definitions

Technology Definitions, seen in Figure 2-4, are used to define the technologies to be included in the batch run. There are 336 technology definition combinations from which to choose. The following are descriptions of the drop downs available within Technology Definitions. Also for ease of use, the filtering option is available for most of the technologies and the parameters, making it easier to select what the user wishes to run.

Figure 2-4: Technology Definitions

Technology Definitions										
Run Number	Run Technology Flag	Technology Name	Sector	Fuel Type	Utility	Climate Region	Utility Ra	Financing Option	Rebate Type	
3	Yes	Gas Turbine (<= 2 MW)	Commercial	Direct Bio-Gas	PG&E	Coast	A10TOU	Debt/Equity	None	
9	Yes	Gas Turbine (<= 2 MW)	Commercial	Direct Bio-Gas	SCE	Coast	GS2TOU	Debt/Equity	None	
15	Yes	Gas Turbine (<= 2 MW)	Commercial	Direct Bio-Gas	SDG&E	Coast	A6TOU	Debt/Equity	None	

- **Run Technology Flag:** Yes/No flag to include or not include a technology in the analysis.
 - To see all technologies, click on the *Run Technology Flag* drop-down button and choose *Select All*.
 - The user can choose to set all flags to *No* or *Yes* using the buttons on the upper right-hand side of the SGIPce (see Figure 2-6).
 - If the flags are in the *Yes* position, the user could turn some technology flags to *No*. Setting the flags to *No* in the Run Technology Flag column removes the technology from the batch run.
 - If the user has a limited number of technologies, they may want to set all technologies to *No* with the *Set Run Tech Flag Off* button from the menu at the top right of the worksheet. Then the user could select the technologies they wish to include in the analysis by setting those technologies to *Yes* in the Run Technology Flag column.
- **Technology Name:** A short description of the technology represented by the line.

- **Sector:** An identifier indicating if the line is for the commercial, government/nonprofit, or residential sector.
- **Fuel Type:** Identifies the type of fuel to be used to run the technology for the current line. The field may take the following values: *natural gas, directed bio-gas, on-site bio-gas*, or *none*.
- **Utility:** An identifier indicating the utility for the current line. This field may have the following values: *PG&E, SCE/SCG, SDG&E*.
- **Climate Region:** An identifier indicating the Climate Region being used by the line. The field may have the following values: *Coast, Inland*.
- **Utility Rate:** The user must choose a utility rate from the drop-down menu.
 - The user is only provided with rates defined in the system that are appropriate for the chosen utility and sector.
- **Financing Option:** The user can choose from the two financing options in the drop-down menu: *Debt/Equity* and *power purchase agreement (PPA)*.
- **Rebate Type:** The user has three rebate options to choose from:
 - If the user chooses *None*, no rebate is provided during the forecasting period
 - *EPBB* is an expected performance based buy down or a first-year rebate. The rebate values are based upon current rebates or plans for future rebates.
 - *PBI* is a performance based incentive or a five-year rebate. The rebate is based upon current rebates or plans for future rebates.
- **Progress Ratio:** The user has the ability to modify the progress ratio currently stored in the technology workbooks. The base value of the progress ratio listed in the technology definitions is *NA*.
 - Leaving the progress ratio at *NA* causes the system to use the current observed progress ratio to determine the future path of technology costs.
 - Changing the progress ratio from *NA* will lead the path of technology costs to differ from those observed in currently learning curve research. The Progress Ratio must be between zero and one. An example of the List of Technologies being used to set the Progress Ratio can be seen in Figure 2-5.
- **Technology Scenario Description:** May be used to differentiate each technology in a run.
 - This field is currently used on the cover page of the Calculation Engine to help differentiate the various runs. The user can select one of three values in the field. They are *NA*, *CapFac* for a change in the Expected Capacity Factor, and *ProgRatio* for a change in the Progress Ratio.
 - Again, this field is informational only and is *not* used to identify the runs in any way.

- **Expected Capacity Factor:** May be used to adjust the production curves to represent a user-specified value for the capacity factor. The production curve is adjusted mathematically so that the average calculates to the specified value if possible.
 - The maximum allowable value for any given hour in the production function is 1.05.
 - The word “Actual” tells the program to use the assigned production function without adjustment.

Figure 2-5: Technology Definitions (continued)

Global Assumptions	
Program Scenario Name	Base Case
Version Description	Version1Release
Default Year	2010
Save Calc for each line?	Yes
Store Results by Utility?	Yes
Update/Replace Results?	No
Save MIRR 10 - 15	No

Batch Process
No Screen Updating

Batch Process
View Screen Updating

Batch Process
Run Unattended

Set Run Tech Flag Off

Reset Progress Ratio
Override

Set Run Tech Flag On

Clear Filters

Technology Name	Sector	Fuel Type	Utility	Climate Region	Utility Ra	Financing Option	Rebate Type	Progress Ratio	Technology Scenario Descripto	Expected Capacity Factor
Gas Turbine (<= 2 MW)	Commercial	Natural Gas	PG&E	Coast	A10TOU	Debt/Equity	EPBB	0.9	ProgRatio	Actual
Gas Turbine (<= 2 MW)	Commercial	Natural Gas	PG&E	Inland	A10TOU	Debt/Equity	EPBB	0.85	ProgRatio	Actual
Gas Turbine (<= 2 MW)	Government/Non-Profit	Natural Gas	PG&E	Coast	A10TOU	Debt/Equity	EPBB	0.95	ProgRatio	Actual
Gas Turbine (<= 2 MW)	Government/Non-Profit	Natural Gas	PG&E	Inland	A10TOU	Debt/Equity	EPBB	0.92	ProgRatio	Actual

SGIPce Batch Processing Buttons

The SGIPce interface includes seven buttons (see Figure 2-6). Three of the seven buttons start the batch processor while four of the buttons are used to set up the Technology definitions. Following are descriptions for the buttons shown in Figure 2-6.

Figure 2-6: SGIPce Buttons

Batch Process
No Screen Updating

Batch Process
View Screen Updating

Batch Process
Run Unattended

Set Run Tech Flag Off

Reset Progress Ratio
Override

Set Run Tech Flag On

Clear Filters

- *Batch Process – No Screen Updating*
 - This button runs the system with minimal screen updating during the run.
 - Some updating is performed after each run to help inform the user as to how far the batch run has progressed.
 - This type of run is faster because the screen is not continuously updated.
 - At the end of this run, any open Results workbooks will be saved automatically with their default names.
- *Batch Process – View Screen Updating*
 - This button runs the system with complete screen updating during the run.
 - Allows the user to view what is happening at all times.
 - Provides a progress bar on the status of the run
 - May impact performance, but the user is never guessing about the progress of the batch run.
 - At the end of this run, the user will be asked to save any open Results workbooks before the VBA code finishes. This allows the user to rename the workbook if desired.
- *Batch Process – Run Unattended*
 - This button is designed for a longer run with many technologies defined.
 - At this time, screen updating is turned on with this run.
 - The difference with this run type is that all workbooks are closed down when the run completes and the SGIPce workbook is save and closed as well. This assures that no information about the run is lost.
 - At the end of this run, any open Results workbooks will be saved automatically with their default names.
- *Clear Filters*
 - This button clears all filters, manually set by the user, limiting the visible rows in the Technology Definitions table.
 - This button should be pressed before using the following three buttons.
- *Set Run Tech Flag Off*
 - This button sets to *No* the list of Run Tech Flag values.
 - Allows for a reset of the flags before defining a new run.
 - The user may select specific technologies after pressing this button to turn them on.
 - For reliable results the user should always press the *Clear Filter* button, described above, before pressing this button. This will ensure that all Run flags are turned off.

- *Set Run Tech Flag On*
 - This button sets to *Yes* the list of Run Tech Flag values.
 - Allows for all technologies to be run at the same time.
 - The user may unselect specific technologies after pressing this button to turn them off.
 - For reliable results the user should always press the *Clear Filter* button, described above, before pressing this button. This will ensure that all Run flags are turned on.
- *Reset Progress Ratio Override*
 - This button sets to *NA* the entire list of Progress Ratio values.
 - Assures that the run being defined does not have any errant values in this column.
 - Values in this column may be set manually to values within the following range:
 - (0 < ratio <= 1)
 - For reliable results the user should always press the *Clear Filter* button, described above, before pressing this button. This will ensure that all Progress Ratio flags are set to *NA*.

2.3.4 What Happens When You Press a Batch Processing Button?

Pressing a batch processing button begins the VBA code that runs through the technologies and produces results for the selected technologies. Before anything further happens, the user has the opportunity to cancel the process before it continues.

Depending on which button is pressed, the user may be able to watch the progress of the runs as the workbooks are opened and closed and data are being moved from the Input workbooks to the Calculation Engine and then to the Results workbook. The operation of each button should be reviewed to determine the best operation for the situation.

At the end of the run, the disposition of the open Results workbooks and the SGIPce workbook is determined based on the button pressed. Be sure to review above how each button treats these workbooks at the end of a run.

2.3.5 Where are the Results?

If the user chooses to save the calculations for each line item (technology), the technology-level results are saved in the CalcEngines folder and the aggregated results with some technology-level information are saved in the Results folder. The *Program Scenario Name* and the *Version Description* are used to help define the name of the CalcEngines folder and the Results workbook. An example of the naming convention follows:

- Combined Results Workbook Naming Convention:
 - Store Results by Utility equals *No*.
 - Only one Results workbook is created.
 - The name is made up of four components.
 - 1. *SGIce_Results_* – prefix for all Results workbooks.
 - 2. *Program Scenario Name* – selected by the user in SGIPce.
 - 3. *Version Description* – defined by the user in the SGIPce.
 - 4. *All* – indicating that all utilities are included in the Results workbook.
- Results Workbook by Utility Naming Convention:
 - Store Results by Utility equals *Yes*.
 - One Results workbook is created for each utility selected in the List of Technologies in SGIPce.
 - The naming convention is the same as for the combined results with one exception:
 - Item number 4 above changes from *All* to the utility’s initials.
 - i.e. *PGE, SCE, SDGE*

2.3.6 Error Log

The other tab of interest in the SGIPce workbook is the Error Log. After each attended batch run, the SGIPce workbook will open with the Error Log displayed. It is important to review this worksheet to determine if there were any errors during the run that might have stopped the system prematurely or may have caused erroneous values to be stored in the results.

Figure 2-7: Error Log

1	2	3	4	5	6	7
Type of Message	Error Number	Source	Programmer Description	Error Description	Time/Date Stamp	Time Difference
Information	NA	SGIPceBatchProcessor	Init Error Handler	None	07/21/2010 07:54:24	
Information	NA	SGIPce_CalcEngine	Starting Run Number: 1; Tech Suffix:ICE1500kW_NR_NG	None	07/21/2010 07:54:43	00:19.0
Information	NA	SGIPce_CalcEngine	Ending Run Indx: 1; Run Number: 1	None	07/21/2010 07:56:34	01:51.0
Information	NA	SGIPceBatchProcessor	Close Error Handler	None	07/21/2010 07:59:03	02:29.0

Following is a description of each of the fields in the Error Log and how they may be interpreted.

- **Type of Message**
 - **Information.** This indicates that the data on this line are for the user's information only. No error is indicated here.
 - **Error.** This indicates that an error has occurred that needs to be addressed for the specified technology.
- **Error Number**
 - **NA.** This indicates that there is not error number. This value should only be seen on information lines.
 - **<numeric value>.** This number can be searched for in the VBA code to determine where the error occurred. With this information, the developer can find the problem and make any necessary corrections to the code or inputs.
 - It is not advised that the user make changes to the code to solve a problem. If code is changed then the users system is no longer compatible with the other versions and cannot be maintained by the developer.
- **Source**
 - This is additional information to help determine the origin of the problem causing the error. While the error might need to be worked on by the developer, the user can review the information in this and other fields to determine if an input error has occurred that they can fix.
- **Programmer Description**
 - This describes the area where the problem occurred in the code.
- **Error Description**
 - This is a more specific comment about the actual area of the code where the problem occurred.
- **Time/Date Stamp**
 - This is the value of the system clock at the time the error was reported.
- **Time Difference**
 - This is the difference in time between the current and previous entries. This is a good indicator of how long each run takes to complete.

Analyzing these codes can be very helpful in determining if an error has occurred to a programming problem or to a problem with the data inputs. When reviewing the error log, the user should always ask, "What has changed since the last run?" This helps identify the problem so that corrections can be made in a timely manner, thereby enabling a successful run.

2.3.7 Calculation Engine

In the system’s root directory is a workbook named *SGIPce_CalcEngine.xlsm*. This is a template that represents the format of the CalcEngine that will be populated with the inputs specified by the current technology line being executed in the batch run. Actual technology-level results are found in the CalcEngines directories. The individual technology CalcEngine workbooks are named for the *Program Scenario Name* and *Version Description* specified in the Technology Description and are further identified using the technology name, sector (commercial = NR, residential = Res, government/non-profit (GNP), fuel, and California utility). The Calculation Engines contain all the information used to generate the results found in the Results workbook for the individual technologies.

The technology-level Calculation Engine includes several tabs of interest, such as Cover Sheet, Results, LCOE, as well as multiple input tabs. Each tab is described briefly below.

Information Tabs

Cover Sheet

The Cover Sheet of the technology-specific Calculation Engine lists the Global Assumptions the user specified in the SGIPce and the Technology Definitions for the individual technology. This shows the basic information used to determine what input data were used to define the technology.

Figure 2-8: Calculation Engine Cover Sheet

SGIPce Program Calculation Engine	
Global Assumptions	
Program Scenario Name	BaseCase
Version Description	Version1Release
Default Year	2010
Save Calc for each line?	Yes
Store Results by Utility?	No
Update/Replace Results?	No
Technology Definitions	
Run Number	39
Technology Name	Fuel Cells (1.2 MW)
Sector	Commercial
Fuel Type	Direct Bio-Gas
Utility	PG&E
Utility Rate	A10TOU
Climate Region	Coast
Financing Option	Debt/Equity
Rebate Type	EPBB
Progress Ratio Override	No Change
Technology Scenario Descriptor	NA
Technology Suffix	FC1200kW_NR_DIRBGas
Expected Capacity Factor	0.8

Calculation Tabs

Results Tab

The Total Resource Cost (TRC) test, the Societal Total Resource Cost (STRC) test, the Participant Cost (PCT) test, and the Program Administrator (PA) Cost test are presented for the technology on the Results tab.

Figure 2-9: Results Page

SGIPce Results										
	Run Number	39	Fuel Type	Direct Bio-Gas	CZ Region	Coast	Progress Ratio	No Change	Expected Cap Fac	0.8
	Tech Name	Fuel Cells (1.2 MW)	Utility	PG&E	Finance	Debt/Equity	Tech Scen	NA		
	Sector	Commercial	Rate	A10TOU	Rebate Type	EPBB	Tech Suffix	C1200kW NR DIRBGas		
Benefit/Cost Test Calculations	Discount Rate	Current Period	2007	2008	2009	2010	2011	2012	2013	2014
TRC										
TRC Benefits		\$1,584,840	\$1,465,823	\$1,488,111	\$1,547,029	\$1,584,840	\$1,617,808	\$1,651,566	\$1,687,254	\$1,723,687
TRC Costs		\$1,719,807	\$1,683,390	\$1,687,829	\$1,723,960	\$1,719,807	\$1,715,978	\$1,714,003	\$1,714,383	\$1,716,304
TRC Net Benefits		(\$134,967)	(\$217,567)	(\$199,719)	(\$176,931)	(\$134,967)	(\$98,169)	(\$62,438)	(\$27,128)	\$7,383
TRC Benefits Ratio		92.2%	87.1%	88.2%	89.7%	92.2%	94.3%	96.4%	98.4%	100.4%
TRC - Societal										
TRC - Societal Benefits		\$1,585,815	\$1,457,807	\$1,487,377	\$1,545,180	\$1,585,815	\$1,622,761	\$1,660,460	\$1,699,779	\$1,739,805
TRC - Societal Costs		\$1,632,667	\$1,584,205	\$1,594,979	\$1,630,591	\$1,632,667	\$1,635,177	\$1,639,360	\$1,645,577	\$1,653,198
TRC - Societal Net Benefits		(\$46,851)	(\$126,398)	(\$107,602)	(\$85,410)	(\$46,851)	(\$12,416)	\$21,100	\$54,202	\$86,607
TRC - Societal Benefits Ratio		97.1%	92.0%	93.3%	94.8%	97.1%	99.2%	101.3%	103.3%	105.2%
PCT										
PCT Benefits		\$2,176,437	\$2,071,055	\$2,093,683	\$2,159,844	\$2,176,437	\$2,194,683	\$2,215,327	\$2,238,763	\$2,265,088
PCT Costs		\$1,923,125	\$1,886,975	\$1,893,396	\$1,928,783	\$1,923,125	\$1,917,471	\$1,913,145	\$1,910,912	\$1,910,718
PCT Net Benefits		\$253,312	\$184,081	\$200,287	\$231,061	\$253,312	\$277,213	\$302,182	\$327,850	\$354,370
PCT Benefits Ratio		113.2%	109.8%	110.6%	112.0%	113.2%	114.5%	115.8%	117.2%	118.5%
PA										
PA Benefits		\$911,865	\$794,979	\$813,969	\$870,197	\$911,865	\$948,468	\$984,928	\$1,022,081	\$1,058,962
PA Costs		\$499,345	\$454,509	\$454,509	\$499,345	\$499,345	\$499,345	\$499,345	\$499,345	\$499,345
PA Net Benefits		\$412,521	\$340,470	\$359,460	\$370,852	\$412,521	\$449,123	\$485,583	\$522,737	\$559,618
PA Benefits Ratio		182.6%	174.9%	179.1%	174.3%	182.6%	189.9%	197.2%	204.7%	212.1%

LCOE Tab

The LCOE tab performs the financial calculations needed to determine the levelized cost of energy. Many of the calculations on this page are also used to help determine the costs and benefits for the cost-benefit tests listed on the Results tab. To ensure consistency with the CSI cost-effectiveness evaluation, this tab was based on the E3 CSI ProForma LCOE tab. The equations have been modified to be consistent with more recent versions of E3’s work and to adapt the calculations for CHP technologies.

Figure 2-10: LCOE ProForma Sheet

Change Default Year		2010							
System Design									
System Cost per Watt (\$/Watt AC/DC) (ALL IN)	5.872093679	Tech							
System Size (Design) (kW AC/DC)	1200	Tech							
Initial debt service reserve funding	\$0.00000	Calc							
Upfront rebate reduction	\$0	Calc							
Total System Cost	\$7,046,512	Calc							
Performance Inputs									
System Size Derate Factor	1.00	Tech							
System Size (Performance) (kW AC)	1,200	Calc							
Annual Net AC Capacity Factor	80.0%	Tech							
Annual Output for Year 1 (kWh)	8,409,600	Tech	8,409,600						
Degradation Factor	1.00%	Tech							
System lifetime (in Years)	20.00	Tech							
Other									
O&M Costs (\$/kWh)	\$0.0300	Tech							
O&M Costs Escalator (%/yr)	2.00%	Global							
Partial Equip Replacement Cost (\$/W)	\$0.00	Tech							
Partial Equip replacement time (in Years)	1	Tech							
Partial Equip replacement cost	\$0.00	Calc?							
Levelized (1yr) Partial Equip replacement cost	-	Calc?							
Insurance Expense Multiplier (%)	0.5%	Tech							
Insurance Escalator (%/yr)	2.00%	Tech							
REC price (\$/kWh)	\$0.035	Tech							
REC price escalator (%/yr)	0.00%	Tech							
REC price multiplier (1.0)	1	Tech							
Tax Assumptions									
Federal Tax Rate	35.00%	Global-Sector							
State Tax Rate	8.84%	Global-Sector							
Effective Tax Rate	40.75%	Global-Sector							
Taxable electricity	0	Calc							
Taxable PBI Incentive (Federally) (1=yes,0=no)	1	Calc							
Federal Tax Credit									
Total System Cost	\$7,046,512	Calc							
Tax Credit Rate	30%	Tech							
Tax Credit Amount	\$2,113,954	Calc							
Tax Savings through Depreciation									
Full Basis Amount	\$7,046,512	Calc							
Basis Reduction (50% of ITC)	15%	Calc							
Depreciation Basis	\$5,989,536	Calc							
MACRS Term	5	Tech							
State Rebate									
Rebate Amount (\$/kWh)	\$0.15	EPBB							
CEC-AC Rating	1,200.0	Calc							
CSI Rating (=CEC-AC * Design Factor)	1,200.0	Calc							
Total Upfront Rebate Amount	\$4,956,000	Calc							
Financing									
% Financed w/ equity	60%	Global-Sector							
% Financed w/ debt	40%	Global-Sector							
Debt Interest rate	7.67%	Global-Sector							
Debt period in years	16	Calc							
Year Debt Placed	1	Calc							
Cost of Equity	10.72%	Calc							
WACC	8.25%	Global							
Interest Rate on DSRF	3.8%	Global							
PPA Escalator	0.00%	Global							
Equity Amount	\$4,227,907	Calc							
Debt Amount	\$2,818,605	Calc							
Program Admin Cost (\$/kW)	\$94.05	Tech							
Program Admin Cost (\$/unit)	\$0.00	Tech							
Output									
Levelized Cost of Generation (\$/kWh)	\$0.0538	Calc							
NPV	\$0.00	Calc							
REC Start Year	2013	Calc							
Number of years rebated	5	Tech							
Inflation Rate	2%	Global							
Years of Debt Service in DSRF	1	Global							
Target DSCR	1.40	Global							
Reinvestment Rate	10.72%	Global							
Design Derate Factor	100.00%	Tech							

Data Tabs

Inputs Tab

The Inputs tab holds the Annual Inputs table seen in Figure 2-11 and lists many of the DG measure inputs and financial assumptions used to calculate the LCOE and the cost-benefit test values. This tab aggregates the inputs for use in the LCOE worksheet. This tab references the subsequent input tabs so that the iterative process of calculating the levelized cost of energy by period can be performed.

Figure 2-11: Annual Input Table

DG Inputs		2007	2008	2009	2010	2011	2012	2013	2014	2015	2016	2017	2018	2019	2020	
Inputs (Itron_wInputTable)		Note: all values in this table are obtained from other input tabs in this workbook.														
System Price																
Measure Price (\$/w)	Tech/Annual	\$6.01	\$6.01	\$6.01	\$5.73	\$5.45	\$5.20	\$4.95	\$4.72	\$4.50	\$4.28	\$4.08	\$3.89	\$3.70	\$3.53	
Inverter Price (\$/w)	Tech/Annual	\$0.00	\$0.00	\$0.00	\$0.00	\$0.00	\$0.00	\$0.00	\$0.00	\$0.00	\$0.00	\$0.00	\$0.00	\$0.00	\$0.00	
Other Costs (\$/w)	Tech/Annual	\$0.14	\$0.14	\$0.14	\$0.15	\$0.15	\$0.15	\$0.16	\$0.16	\$0.16	\$0.16	\$0.17	\$0.17	\$0.18	\$0.18	
System Cost per kWatt		\$6.15	\$6.15	\$6.15	\$5.97	\$5.67	\$5.35	\$5.11	\$4.88	\$4.66	\$4.45	\$4.25	\$4.06	\$3.89	\$3.77	
Performance Inputs																
Annual Net Capacity Factor	Tech/Const	80%	80%	80%	80%	80%	80%	80%	80%	80%	80%	80%	80%	80%	80%	
System lifetime (Years)	Tech/Const	20	20	20	20	20	20	20	20	20	20	20	20	20	20	
Degradation Factor (%/yr)	Tech/Const	1%	1%	1%	1%	1%	1%	1%	1%	1%	1%	1%	1%	1%	1%	
DC to AC derate factor	Tech/Const	100%	100%	100%	100%	100%	100%	100%	100%	100%	100%	100%	100%	100%	100%	
Cost Inputs																
O&M Costs (\$/kWh)	Tech/Annual	\$0.03	\$0.03	\$0.03	\$0.03	\$0.03	\$0.03	\$0.03	\$0.03	\$0.03	\$0.03	\$0.03	\$0.03	\$0.03	\$0.03	
O&M Cost Escalator (%/yr)	Global	2.00%	2.00%	2.00%	2.00%	2.00%	2.00%	2.00%	2.00%	2.00%	2.00%	2.00%	2.00%	2.00%	2.00%	
Partial Equip replacement costs (\$/w)	Tech/Annual	\$0.00	\$0.00	\$0.00	\$0.00	\$0.00	\$0.00	\$0.00	\$0.00	\$0.00	\$0.00	\$0.00	\$0.00	\$0.00	\$0.00	
Partial Equip replacement time (Years)	Tech/Const	1	1	1	1	1	1	1	1	1	1	1	1	1	1	
Insurance Expense Multiplier (%)	Global	0.5%	0.5%	0.5%	0.5%	0.5%	0.5%	0.5%	0.5%	0.5%	0.5%	0.5%	0.5%	0.5%	0.5%	
Insurance Escalator (%/yr)	Global	2.00%	2.00%	2.00%	2.00%	2.00%	2.00%	2.00%	2.00%	2.00%	2.00%	2.00%	2.00%	2.00%	2.00%	
REC price (\$/w)	Tech	\$ 0.035	\$ 0.035	\$ 0.035	\$ 0.035	\$ 0.035	\$ 0.035	\$ 0.035	\$ 0.035	\$ 0.035	\$ 0.035	\$ 0.035	\$ 0.035	\$ 0.035	\$ 0.035	
REC price escalator (%/yr)	Tech	0%	0%	0%	0%	0%	0%	0%	0%	0%	0%	0%	0%	0%	0%	
REC price multiplier	Tech/Global?	1	1	1	1	1	1	1	1	1	1	1	1	1	1	
Finance Inputs																
Federal Tax Rate	Finance	35%	35%	35%	35%	35%	35%	35%	35%	35%	35%	35%	35%	35%	35%	
State Tax Rate	Finance	3%	3%	3%	3%	3%	3%	3%	3%	3%	3%	3%	3%	3%	3%	
Tax Credit Rate	Tech	30%	30%	30%	30%	30%	30%	30%	30%	30%	30%	0%	0%	0%	0%	
Percent financed with Equity	Finance	60%	60%	60%	60%	60%	60%	60%	60%	60%	60%	60%	60%	60%	60%	
Debt Interest Rate	Finance	8%	8%	8%	8%	8%	8%	8%	8%	8%	8%	8%	8%	8%	8%	
Target DSCR	Finance	140%	140%	140%	140%	140%	140%	140%	140%	140%	140%	140%	140%	140%	140%	
Years of Debt Service in DSRF	Finance	1	1	1	1	1	1	1	1	1	1	1	1	1	1	
WACC	Finance	8%	8%	8%	8%	8%	8%	8%	8%	8%	8%	8%	8%	8%	8%	
Cost of Equity	Finance	11%	11%	11%	11%	11%	11%	11%	11%	11%	11%	11%	11%	11%	11%	
Rates																
Retail rate (\$/kWh)	Rates	\$0.14	\$0.13	\$0.13	\$0.12	\$0.13	\$0.13	\$0.14	\$0.14	\$0.14	\$0.15	\$0.16	\$0.16	\$0.17	\$0.17	
PBI Avg Rebate Amount (\$/kWh)	Tech/Annual	\$0.13	\$0.13	\$0.15	\$0.15	\$0.15	\$0.15	\$0.15	\$0.15	\$0.15	\$0.15	\$0.15	\$0.15	\$0.15	\$0.15	
EPBB Avg Rebate amount (\$/w)	Tech/Annual	\$3.75	\$3.75	\$4.13	\$4.13	\$4.13	\$4.13	\$4.13	\$4.13	\$4.13	\$4.13	\$4.13	\$4.13	\$4.13	\$4.13	
Inflation Rate (%/yr)	Global/Annual	2.00%	2.00%	2.00%	2.00%	2.00%	2.00%	2.00%	2.00%	2.00%	2.00%	2.00%	2.00%	2.00%	2.00%	
Program Administrative Costs (\$/kWh)	Tech	\$94.05	\$94.05	\$94.05	\$94.05	\$94.05	\$94.05	\$94.05	\$94.05	\$94.05	\$94.05	\$94.05	\$94.05	\$94.05	\$94.05	
Program Administrative Costs (\$/kWh)	Tech	\$94.05	\$94.05	\$94.05	\$94.05	\$94.05	\$94.05	\$94.05	\$94.05	\$94.05	\$94.05	\$94.05	\$94.05	\$94.05	\$94.05	
Program Admin Cost Escalator (%/yr)	Tech	0.00%	0.00%	0.00%	0.00%	0.00%	0.00%	0.00%	0.00%	0.00%	0.00%	0.00%	0.00%	0.00%	0.00%	
Apply Tax Credit	Finance	1	1	1	1	1	1	1	1	1	1	1	1	1	1	

Technology Tab

The Technology tab holds the Technology Level Constants Table as see in Figure 2-12, which lists the technology constants used to calculate the LCOE and the cost-benefit tests. These data are retrieved from the appropriate technology input workbook.

Figure 2-12: Technology-Level Constants

Technology Level Constants		
Inputs by Tech	Value	Comments
Degradation Factor	0.01	Mapped to Input Tab
System lifetime (in Years)	20	Mapped to Input Tab
Emissions Factors - CO (lbs/MWh)	863.25	Used in LCOE worksheet
Emissions Factors - NOx (lbs/MWh)	0.033333333	Used in LCOE worksheet
Emissions Factors - PM10 (lbs/MWh)	0.00002	Used in LCOE worksheet
Depreciation Term	5	Mapped to LCOE tab H25
Partial Equip replacement cost (\$/W)	0	
Partial Equip Replacement Time (years)	0	Mapped to Input Tab. Needs clarification
Program Admin Cost (nonrebate, \$/unit)	\$0.00	Used for PV
Program Admin Cost (nonrebate, \$/kW)	\$94.05	Used for non-PV technologies
PAC price escalator (%/yr)	0.0%	Program Admin Cost Price Escalator
Annual Electric Production	8,409,600	From Technology Production Curves
Annual Electric Charging	0	From Technology Charging Curves for Storage
Annual Gas Production Therms Req'd	623772.9391	From Technology Production Curves
Annual Gas Production Therms Out	154736.64	From Technology Production Curves
On-site Biogas Technology?	FALSE	Controls inputs during calculation
Design Derate Factor	100.00%	Should be 100% for all techs except PV when it is initialized
Installed at a Dairy?	No	Was Technology installed at a Dairy?
Pay Departing Charge?	No	Should Departing Charges be Applied?

Note: all values on this worksheet are obtained from the technology workbook selected for the run.
 Annual Production values are retrieved from the TechnologyProduction worksheet.
 All other values come from the Constants worksheet.
 The workbook names are found in the Inputs sub-directory and have the prefix SGIPce_Inputs_Tech_xx.xlsx

Annual Inputs Tab

This tab lists many of the technology annual inputs used to calculate the LCOE and the cost-benefit tests. Items included on the Annual Inputs tab include the price of the DG technology and how market transformation impacts the price of the technology.

Figure 2-13: Technology-Level Annual Inputs

Short-term Inputs (14 periods)								
System Prices		Est. Growth Rate	2007	2008	2009	2010	2011	2012
Cumulative global capacity	(MW)	26%	133	184	214	271	341	431
Price	(nominal \$/W)	81.62%	\$ 6.01	\$ 6.01	\$ 6.01	\$ 5.73	\$ 5.45	\$ 5.20
Historical Price	(nominal \$/kW)	81.62%	\$6,009	\$6,009	\$6,009			
The values in orange are obtained from the technology workbook selected for this run on the worksheet named AnnualInputs								
Other Prices		Escalator	2007	2008	2009	2010	2011	2012
Inverter Price	(\$/W)	0%	\$0.00	\$0.00	\$0.00	\$0.00	\$0.00	\$0.00
Historical Other Prices	(\$/W)	0%	\$0.14	\$0.14	\$0.14	\$0.15	\$0.15	\$0.15
Inverter Price	(\$/kW)		\$0.00	\$0.00	\$0.00			
Historical Other Prices	(\$/kW)		\$144.00	\$144.00	\$144.00			
The values in orange are obtained from the technology workbook selected for this run on the worksheet named AnnualInputs. Inverter Price is not currently used.								
O&M		Escalator	2007	2008	2009	2010	2011	2012
Cost	(\$/kWh)	0%	\$0.03	\$0.03	\$0.03	\$0.03	\$0.03	\$0.03
Historical Cost	(\$/kWh)		\$0.03	\$0.03	\$0.03			
The values in orange are obtained from the technology workbook selected for this run on the worksheet named AnnualInputs. Inverter Price is not currently used.								
REC Inputs			2007	2008	2009	2010	2011	2012
Price	(\$/W)		\$0.035	\$0.035	\$0.035	\$0.035	\$0.035	\$0.035
Escalator	(%/Yr)		0.0%	0.0%	0.0%	0.0%	0.0%	0.0%
Multiplier	(1.0)		1	1	1	1	1	1
The values in orange are obtained from the technology workbook selected for this run on the worksheet named AnnualInputs								

Finance Tab

The Finance tab lists the financial inputs used to calculate the LCOE and the cost-benefit tests. This tab includes both the Global and Annual inputs needed for the financial calculations in the LCOE worksheet.

Figure 2-14: Global Finance Inputs

Global Variables														
Utility Discount Rate	8.65%	This value is initialize from SGIPce_Inputs_Global.xlsm on the Global_Constants tab												
Societal Discount Rate	5.06%	This value is initialize from SGIPce_Inputs_Global.xlsm on the Global_Constants tab												
PPA Escalator	0.00%													
Rebate Type	3	None = 1, PBI = 2, EPBB = 3												
Financing Inputs														
Debt/Equity			2007	2008	2009	2010	2011	2012	2013	2014	2015	2016	2017	2018
Federal Tax Rate			35%	35%	35%	35%	35%	35%	35%	35%	35%	35%	35%	35%
State Tax Rate			8.84%	8.84%	8.84%	8.84%	8.84%	8.84%	8.84%	8.84%	8.84%	8.84%	8.84%	8.84%
Apply Tax Credit			1	1	1	1	1	1	1	1	1	1	1	1
Percent financed with Equity			60%	60%	60%	60%	60%	60%	60%	60%	60%	60%	60%	60%
Debt Interest Rate			0.08	0.08	0.08	0.08	0.08	0.08	0.08	0.08	0.08	0.08	0.08	0.08
Target DSCR			1.40	1.40	1.40	1.40	1.40	1.40	1.40	1.40	1.40	1.40	1.40	1.40
Years of Debt Service in DSRF			1	1	1	1	1	1	1	1	1	1	1	1
WACC			8.25%	8.25%	8.25%	8.25%	8.25%	8.25%	8.25%	8.25%	8.25%	8.25%	8.25%	8.25%
Cost of Equity			10.72%	10.72%	10.72%	10.72%	10.72%	10.72%	10.72%	10.72%	10.72%	10.72%	10.72%	10.72%
			-	-	-	-	-	-	-	-	-	-	-	-
			-	-	-	-	-	-	-	-	-	-	-	-
			-	-	-	-	-	-	-	-	-	-	-	-

Note: all values in yellow are initialized from the SGIPce_Inputs_Global.xlsm workbook.
 They come from the tab named Global_Financing
 Greyed values are not used

2.3.8 Results Workbook

The Results workbook lists the aggregated results for the analysis across all technologies included in the run and has individual technology Results tabs for each technology included in the batch analysis. The Results workbook includes a cover sheet, a technology-level Adoption tab, a tab summarizing the technology-specific per-unit cost-benefit results, a tab summarizing the total technology cost-benefit results, and technology-specific results tabs.

Results Cover Tab

The Results Cover tab lists the *Program Scenario Name* and *Version Description*. These fields help to ensure that the user is looking at the desired set of output.

Figure 2-15: Results Cover

SGIPce Program Results	
Global Assumptions	
Program Scenario Name	BaseCase
Version Description	Version1Release
Default Year	2010

Results Adoption Tab

The Results Adoption tab includes an estimate of the technology MW adoption for each technology and year. The technology adoptions for the years 2007-2009 are based on historical data while the values for 2010-2020 are based on the Energy Commission *Road Map of Distributed Generation*² and on the ICF *Market Distributed Generation Market Potential Study*.³

Figure 2-16: Results Adoption

Adoptions (MW)	per Unit	2007	2008	2009	2010	2011	2012	2013	2014	2015	2016	2017	2018	2019	2020	Units
PVCoast_Res_NA_PGE_C	0.004	2.5	5.0	5.0	5.5	6.1	6.7	7.3	8.1	8.9	9.7	10.7	11.8	13.0	14.3	625
PVCoast_Res_NA_SCE_C	0.004	2.5	5.0	5.0	6.0	7.2	8.6	10.4	12.4	14.9	17.9	21.5	25.8	31.0	37.2	625
PVCoast_Res_NA_SDGE_C	0.004	1.5	3.0	3.0	3.6	4.3	5.2	6.2	7.5	9.0	10.7	12.9	15.5	18.6	22.3	375
PVinland_Res_NA_PGE_I	0.005	2.5	5.0	5.0	5.5	6.1	6.7	7.3	8.1	8.9	9.7	10.7	11.8	13.0	14.3	500
PVinland_Res_NA_SCE_I	0.005	2.5	5.0	5.0	6.0	7.2	8.6	10.4	12.4	14.9	17.9	21.5	25.8	31.0	37.2	500
PVinland_Res_NA_SDGE_I	0.005	1.5	3.0	3.0	3.6	4.3	5.2	6.2	7.5	9.0	10.7	12.9	15.5	18.6	22.3	300
WD10kW_Res_NA_PGE_C	0.010	-	-	-	0.1	0.1	0.1	0.1	0.1	0.1	0.1	0.1	0.1	0.1	0.1	-
WD10kW_Res_NA_SCE_I	0.010	-	-	-	0.1	0.1	0.1	0.1	0.1	0.1	0.1	0.1	0.1	0.1	0.1	-
WD10kW_Res_NA_SCE_C	0.010	-	-	-	0.0	0.0	0.0	0.0	0.0	0.0	0.1	0.1	0.1	0.1	0.1	-
WD10kW_Res_NA_SCE_I	0.010	-	-	-	0.1	0.1	0.1	0.1	0.1	0.1	0.1	0.1	0.2	0.2	0.2	-
WD10kW_Res_NA_SDGE_C	0.010	-	-	-	0.0	0.0	0.0	0.0	0.0	0.0	0.0	0.0	0.0	0.0	0.1	-
WD10kW_Res_NA_SDGE_I	0.010	-	-	-	0.1	0.1	0.1	0.1	0.1	0.1	0.1	0.2	0.2	0.2	0.2	-
PVCoast_GNP_NA_PGE_C	0.045	0.6	1.2	1.2	1.4	1.6	1.8	2.1	2.4	2.8	3.2	3.7	4.2	4.9	5.6	13
PVCoast_NR_NA_PGE_C	0.045	2.4	4.8	4.8	5.5	6.3	7.3	8.4	9.7	11.1	12.8	14.7	16.9	19.4	22.3	53
PVCoast_GNP_NA_SCE_C	0.045	0.6	1.2	1.2	1.3	1.5	1.6	1.8	1.9	2.1	2.3	2.6	2.8	3.1	3.4	13
PVCoast_NR_NA_SCE_C	0.045	2.4	4.8	4.8	5.3	5.8	6.4	7.0	7.7	8.5	9.4	10.3	11.3	12.4	13.7	53
PVCoast_GNP_NA_SDGE_C	0.045	0.2	0.4	0.4	0.4	0.5	0.6	0.7	0.9	1.1	1.3	1.5	1.9	2.2	2.7	4
PVCoast_NR_NA_SDGE_C	0.045	0.7	1.4	1.4	1.7	2.1	2.5	3.0	3.6	4.3	5.2	6.2	7.4	8.9	10.7	16
PVinland_GNP_NA_PGE_I	0.062	1.4	2.8	2.8	3.2	3.7	4.3	4.9	5.6	6.5	7.4	8.6	9.9	11.3	13.0	23
PVinland_NR_NA_PGE_I	0.062	5.6	11.2	11.2	12.9	14.8	17.0	19.6	22.5	25.9	29.8	34.3	39.4	45.3	52.1	90
PVinland_GNP_NA_SCE_I	0.062	1.4	2.8	2.8	3.1	3.4	3.7	4.1	4.5	5.0	5.5	6.0	6.6	7.3	8.0	23
PVinland_NR_NA_SCE_I	0.062	5.6	11.2	11.2	12.3	13.6	14.9	16.4	18.0	19.8	21.8	24.0	26.4	29.0	32.0	90
PVinland_GNP_NA_SDGE_I	0.062	0.4	0.8	0.8	1.0	1.2	1.5	1.7	2.1	2.5	3.0	3.6	4.3	5.2	6.2	7
PVinland_NR_NA_SDGE_I	0.062	1.7	3.4	3.4	4.0	4.8	5.8	7.0	8.4	10.0	12.0	14.4	17.3	20.8	25.0	27
WD1MW_GNP_NA_PGE_C	1.000	-	-	0.0	0.0	0.0	0.0	0.1	0.1	0.1	0.1	0.1	0.1	0.1	0.1	-
WD1MW_NR_NA_PGE_C	1.000	-	-	0.1	0.1	0.1	0.2	0.2	0.2	0.3	0.3	0.3	0.4	0.4	0.5	-
WD1MW_GNP_NA_SCE_I	1.000	-	-	0.0	0.0	0.0	0.0	0.0	0.1	0.1	0.1	0.1	0.1	0.1	0.1	-
WD1MW_NR_NA_SCE_I	1.000	-	-	0.1	0.1	0.1	0.2	0.2	0.2	0.3	0.3	0.3	0.4	0.4	0.5	-

² “Distributed Generation and Cogeneration Policy Roadmap for California,” CEC-500-2007-021, March 2007

³ “Combined Heat and Power Market Assessment,” prepared for the California Energy Commission, ICF, CEC-500-2009-094-D, October 2009

Summary Stats Per Unit

The Summary Stats Per Unit tab lists the net present value of the technology rebates, the TRC ratios and their levelized components, the STRC ratios and their levelized components, the PCT ratios and their levelized components, and the PA ratios with their component costs and benefits.

Figure 2-17: Summary Stats Per Unit

	C	D	E	F	G	H	I	J	K	L	M	N
3			Total PA Rebates			TRC Ratios			TRC - Societal Benefits			TRC - So
4	List of Technologies	MW per Unit	2010	2016	2020	2010	2016	2020	2010	2016	2020	2010
5	GTle2MW_NR_NG_PGE_I	1.00	\$0	\$736,309	\$736,309	88%	86%	85%	\$1,398,273	\$1,678,571	\$1,862,357	\$1,597,658
6	FC1200kW_NR_DIRBGas_SCE_C	1.20	\$4,561,436	\$4,561,436	\$4,561,436	99%	111%	113%	\$1,596,539	\$1,847,365	\$1,953,014	\$1,620,690
7	MT200kW_NR_DIRBGas_SDGE_C	0.20	\$0	\$239,301	\$239,301	119%	117%	117%	\$352,781	\$430,535	\$485,512	\$297,385
8	Template	0.00	\$0	\$0	\$0	0%	0%	0%	\$0	\$0	\$0	\$0
9	Template	0.00	\$0	\$0	\$0	0%	0%	0%	\$0	\$0	\$0	\$0

Summary Stats Total

The Summary Stats Total tab lists the technologies and the total value of adoptions, rebates, and the TRC, PCT, and PA ratios by aggregate technology grouping. The tab also includes graphics of the total adoptions by aggregate technology and the total TRC, PCT, and PA ratios for the program over the 2007-2020 period.

Figure 2-18: Summary Stats Total

	C	D	E	F	G	H	I	J	K	L	M	T	U	V
3			Adoptions - MW			Total PA Rebates (\$000)			TRC Ratios			PCT Ratios		
4	List of Technology Goups		2010	2016	2020	2010	2016	2020	2010	2016	2020	2010	2016	2020
5	Totals		0.1	1.3	3.8	\$534	\$3,062	\$8,744	99%	97%	96%	111%	104%	104%
6	Res		0.0	0.0	0.0	\$0	\$0	\$0	N/A	N/A	N/A	N/A	N/A	N/A
7	PV		0.0	0.0	0.0	\$0	\$0	\$0	N/A	N/A	N/A	N/A	N/A	N/A
8	Wind		0.0	0.0	0.0	\$0	\$0	\$0	N/A	N/A	N/A	N/A	N/A	N/A
9	Fuel Cell		0.0	0.0	0.0	\$0	\$0	\$0	N/A	N/A	N/A	N/A	N/A	N/A
10	Storage		0.0	0.0	0.0	\$0	\$0	\$0	N/A	N/A	N/A	N/A	N/A	N/A
11	NonRes		0.1	1.3	3.8	\$534	\$3,062	\$8,744	99%	97%	96%	111%	104%	104%
12	PV		0.0	0.0	0.0	\$0	\$0	\$0	N/A	N/A	N/A	N/A	N/A	N/A
13	Wind		0.0	0.0	0.0	\$0	\$0	\$0	N/A	N/A	N/A	N/A	N/A	N/A
14	Fuel Cell		0.1	0.7	1.9	\$534	\$2,576	\$7,357	99%	111%	113%	111%	119%	119%
15	Storage		0.0	0.0	0.0	\$0	\$0	\$0	N/A	N/A	N/A	N/A	N/A	N/A
16	ICE		0.0	0.0	0.0	\$0	\$0	\$0	N/A	N/A	N/A	N/A	N/A	N/A
17	ORC Engine		0.0	0.0	0.0	\$0	\$0	\$0	N/A	N/A	N/A	N/A	N/A	N/A
18	Micro Turbine		0.0	0.0	0.0	\$0	\$0	\$0	N/A	N/A	N/A	N/A	N/A	N/A
19	Gas Turbine		0.0	0.7	1.9	\$0	\$486	\$1,387	N/A	86%	85%	N/A	88%	90%
21	List of Technologies	MW per Unit	2010	2016	2020	2010	2016	2020	2010	2016	2020	2010	2016	2020
22	GTle2MW_NR_NG_PGE_I	1.00	-	0.7	1.9	\$0	\$486	\$1,387	88%	86%	85%	79%	88%	90%
23	FC1200kW_NR_DIRBGas_SCE_C	1.20	0.1	0.7	1.9	\$534	\$2,576	\$7,357	99%	111%	113%	111%	119%	119%
24	MT200kW_NR_DIRBGas_SDGE_C	0.20	-	-	-	\$0	\$0	\$0	119%	117%	117%	77%	82%	82%
25	Template	0.00	-	-	-	\$0	\$0	\$0	0%	0%	0%	0%	0%	0%
26	Template	0.00	-	-	-	\$0	\$0	\$0	0%	0%	0%	0%	0%	0%
27	Template	0.00	-	-	-	\$0	\$0	\$0	0%	0%	0%	0%	0%	0%
28	Template	0.00	-	-	-	\$0	\$0	\$0	0%	0%	0%	0%	0%	0%
29	Template	0.00	-	-	-	\$0	\$0	\$0	0%	0%	0%	0%	0%	0%
30	Template	0.00	-	-	-	\$0	\$0	\$0	0%	0%	0%	0%	0%	0%
31	Template	0.00	-	-	-	\$0	\$0	\$0	0%	0%	0%	0%	0%	0%
32	Template	0.00	-	-	-	\$0	\$0	\$0	0%	0%	0%	0%	0%	0%

Other Results Workbook Tabs

In addition to the tabs described above there are other tabs that supply data to this workbook. The Template tab is used by the system to provide a place for the results to be placed after each technology combination is simulated. The system makes a copy of the Template tab and renames it based on the name of the technology combination. The data from that run is copied into this new tab from the Results tab found in the CalcEngine. For every technology combination in the batch run one tab is created that holds the results for that technology combination. The number of tabs holding results will match the number of technology combinations found in the technology list in SGIPce.

2.4 Additional Workbooks

In addition to the workbooks described in this section there are numerous other workbooks found in the Inputs directory that contain data for the system. As this is a Quick Start Guide these additional workbooks are not described here. Please consult the other sections of the User Guide for a complete description of these workbooks and how they are used by the system.

3

Overview of SGIPce

3.1 Overview

The SGIPce model is designed to provide a publicly available modeling tool that allows the California Public Utilities Commission (CPUC), utilities, and distributed generation (DG) stakeholders the ability to evaluate the cost-effectiveness of DG technologies or a portfolio of DG technologies (i.e., DG program) currently and in the future.

This section is designed to give the user an overview of the system structure. Each of the pieces of the system are discussed in broad terms to help orient the user as to where things are in the system. A brief discussion of how the system runs is also presented to complete the overview. A more thorough discussion of these concepts will be presented in the following sections.

3.2 The SGIPce System

3.2.1 Model Objectives

The model objectives are as follows:

- Uses the Standard Practice Manual tests modified in accordance with the ALJ ruling to evaluate cost-effectiveness (08-03-008).¹ Tests implemented are as follows:
 - Participant Cost Test,
 - Total Resource Cost Test,
 - Societal Total Resource Cost Test, and
 - Program Administrator Cost Test.
- Provides comprehensive coverage of DG technologies.
 - Technologies implemented include PV; wind; natural gas, directed natural gas and biogas-fueled CHP microturbines, IC engines, gas turbines, ORC, and fuel cells and fuel cells without heat usage.
 - Also included is storage/dispatch.

¹ California Public Utilities Commission, R.08-03-008, June 19, 2009.

- Allows evaluation of DG technologies currently and in the future
 - Based on historical costs and metered performance.
 - Projects costs and energy production based on learning curves, program requirements and observed production of metered technologies currently installed.

3.2.2 Model Outputs and Results

The model outputs data at both the technology and program level. The cost-effectiveness calculations are performed at the technology level. The adoption inputs are incorporated to allow for the aggregate calculation of the cost-effectiveness inputs and test values across technologies, sectors, and for the overall portfolio of technologies. Included in these outputs and results are the following:

- Levelized Lifetime Values of all inputs to the calculation of the Levelized Cost of Energy (LCOE).
- Values are generated using discount rates at the Participant, Societal, and Utility level.
- The values are stored at the technology combination level which is defined by the user to include a technology, sector, fuel type, utility, climate region, utility rate, financing option, type of rebate.
 - A map of the climate regions can be seen in Figure 3-1.
- From these values, the components of the various benefit/cost test are calculated.
- The application of adoptions allows for the calculation of the tests at the technology, sector, and overall levels.
- The program-level results list the program-level benefits and costs, the energy savings, and the rebates included in the model.

Figure 3-1: Climate Regions in California

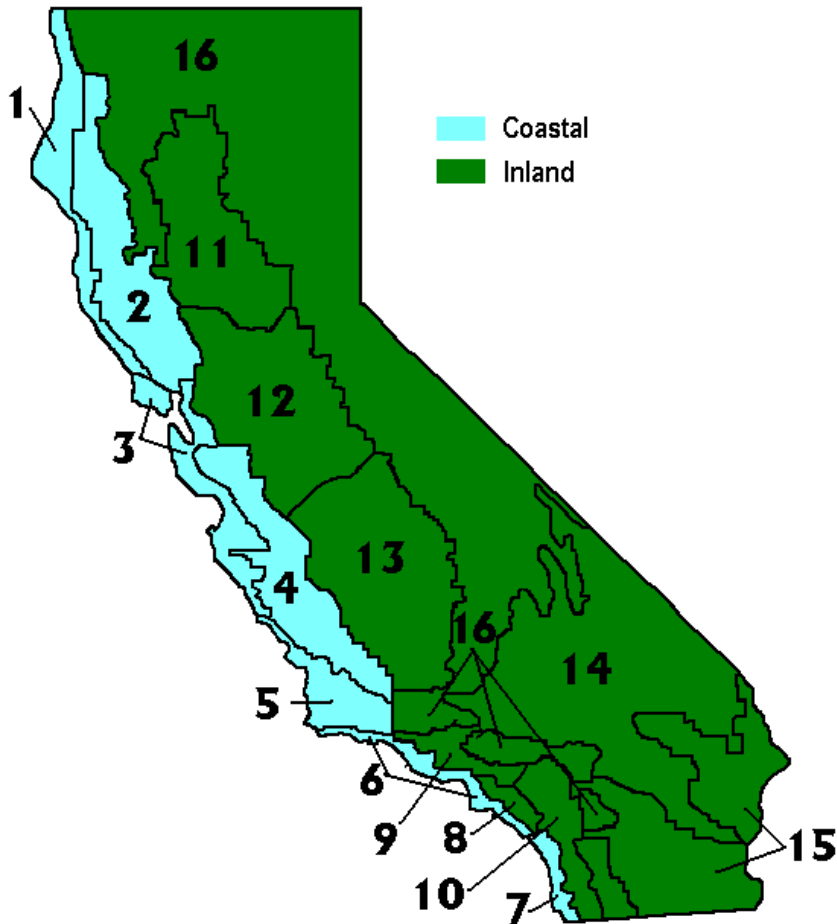

3.2.3 Model Structure

The general structure of the model can be seen in Figure 3-2 below. Each box in this figure represents one or more Excel 2007 workbooks. Each workbook serves various needs required by the system. The boxes will be briefly described here and in more detail in the following sections of this document.

SGIPce Run Processor

The first box found in Figure 3-2 shows a box representing the SGIPce Run Processor. The SGIPce Run Processor is the controlling workbook for the system. It is where the user starts the system and where the batch runs are defined. Once a run is defined the user presses a processor button which calls routines in the Calculation Engine. Pressing the processor button starts the process of calculating the results as defined by the user. Setting up the run processor to perform a simulation will be discussed later in this guide.

Technology Inputs

This box represents a set of workbooks that define the inputs for all technologies available in the system. There is one workbook for each technology, size, sector, and type of fuel. In the case of the ORC, PV, Storage, and Wind technologies the fuel type is not considered. These workbooks have a corresponding set of line items in the Run Processor allowing the user to specify other characteristics about them to more accurately define the desired run criteria. The technology specification process within the Run Processor will be more clearly explained in future sections.

Figure 3-2: SGIPce Model Flow

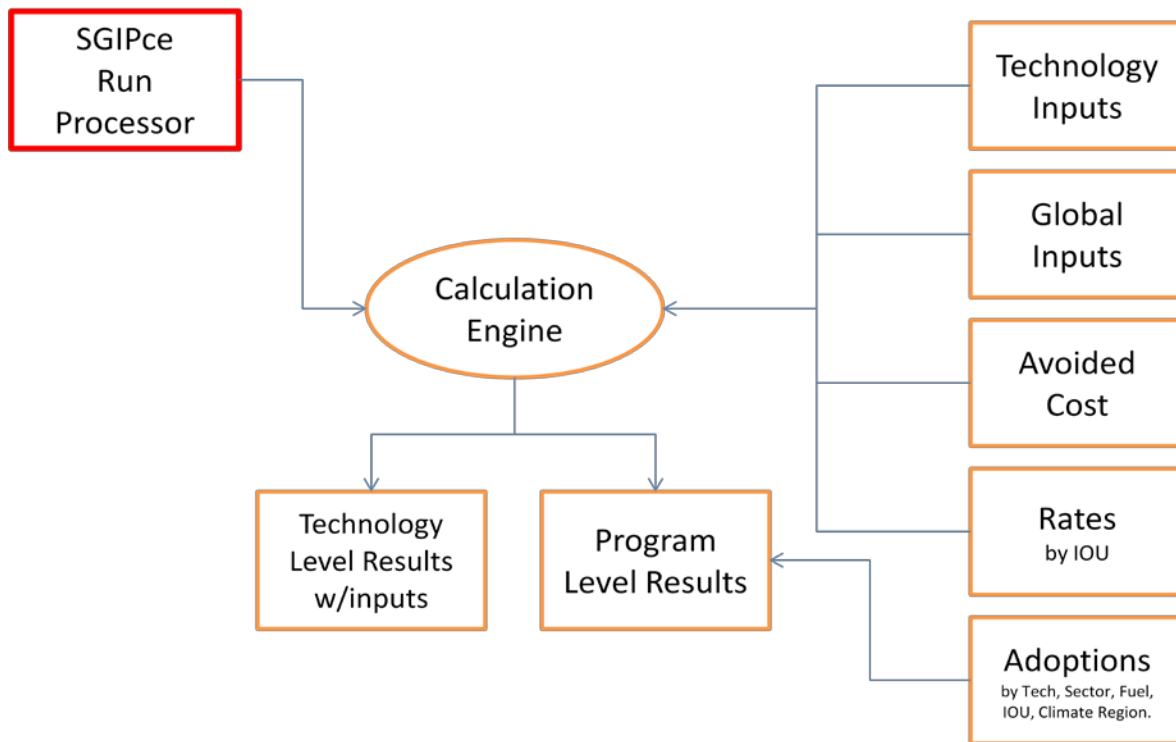

The Technology Input workbooks define all aspects of the technology data necessary to run a technology in the system. The inputs include global technology-level data (*Constants*) that do not change over time like system size, degradation, emissions, etc. The workbooks include annual inputs (*AnnualInputs*) that have a time component to them like system installation costs, rebates, and operating and maintenance costs. Also defined in the technology workbooks is the level of production (*TechnologyProduction & ProductionCurves*) expected from the system for each hour of the year (i.e. 8,760 hours per year).

The system retrieves the technology-level data from the Technology Input workbooks. There are, however, a number of supplementary worksheets in the technology workbooks. These worksheets should be considered working papers used by the engineers that developed the data

for each technology. The supplemental tabs document the sources of data used and are referenced by the Technology Input worksheet.

Global Inputs

This box represents a workbook that contains data used by all technologies. Included in this workbook are data for various financing options having a time component, global inputs that are also time-dependent, and global inputs that are not time-dependent.

Avoided Cost

The Avoided Cost box in Figure 3-2 represents four workbooks that contain the electric and gas avoided costs. The electric avoided costs are stored in a workbook that holds the values by utility and climate region (i.e. coastal and inland) and for the base case and high cost scenario of avoided cost. The high cost scenario is used in the calculation of the greenhouse gas scenario. The avoided costs are sets of 8,760 values based on the 2009 calendar and span the period from 2008 through 2040. These values were derived from the E3 electric and gas avoided cost workbooks that were developed for the SGIP program.² To calculate the model inputs for the avoided cost benefits, the production curve for the current technology is supplied to the workbook, the production curve and the yearly 8760 avoided cost values are multiplied leading to the calculation of a stream of annual values that are then supplied to the calculation engine.

For the gas avoided cost the data are similar in nature to the electric avoided costs with the following differences:

- The gas avoided costs differ by sector and are aggregated to a monthly level.
- The gas avoided costs are developed by sector because the greenhouse gas emissions differ by the underlying technology (boiler vs furnace).
- The gas avoided costs are not provided at the 8760 level because gas consumption and heat usage is only monitored monthly, therefore the avoided costs are supplied at that level.
- The gas avoided costs span the same period as the electric avoided costs.
- Two production curves are supplied to the workbook, therms required to fuel the CHP distributed generation technology and therms saved from capturing the heat from the CHP distributed generation technology. As expected two streams of values are calculated from these production curves and supplied back to the calculation engine, one for each production curve. There will be more on this in later sections.

² The exact E3 avoided cost workbooks were labeled *SGIP_2009ElecAvoidedCostModule_5-4-2010* and *SGIP_GasAvoidedCostModule*.

A set of gas avoided costs were also developed using only the transmission and distribution components of the benefits. These values are needed for non-core customers when calculating the PA cost tests.

Rates

The rates box in Figure 3-2 represent a number of workbooks designed to supply utility rate information to the system. Rates are defined for the residential and non-residential sectors. Due to the complex nature of rates, the non-residential rates are defined in separate workbooks for each utility and rate defined. For the residential sector it was possible to combine all rate definitions into one workbook. There is also a third workbook that defines the gas rates for the non-residential sector. The non-residential gas rates workbook provides rates from non-core gas customers with a reduced transmission and distribution fee for CHP gas required to run the distributed generation measures. This workbook also provides the rate information, with the standard transmission and distribution fee, for the valuation of the natural gas saved from capturing the heat generated by the CHP distributed generation measure.

The structure of the rates workbooks is similar in nature to the avoided cost workbooks in that the electric workbooks are defined for 8,760 hours over the entire possible lifetime of the technologies, in this case 2007 to 2040. The technology production curve is supplied to the workbook and a stream of annual values is provided to the calculation engine. For the rates, however, there is a secondary set of worksheets that define the rates. These worksheets are used to calculate the vast number of values needed for the yearly calculation based on production. The structure of these workbooks will be discussed later.

It should be noted that due to the tremendous number of calculations the link between the secondary worksheets and the main worksheet for the non-residential rate was broken to help minimize the calculation time during the batch runs. A separate workbook with all calculations has been maintained in the event that changes are needed or new rates are desired for future runs.

Both the gas avoided cost workbook and the nonresidential gas rates workbook are defined at the monthly level. The quantity of natural gas required to fuel the DG technology and the natural gas savings from heat capture are supplied to the workbook in monthly values. The rates workbook multiplies the gas needed and the gas saved by the appropriate rates and then provides the calculation engine with the value of the net increase in gas consumption.

The residential workbook contains both gas and electric rates in one workbook. The workbook contains two worksheets that aggregate the data needed by the system and uses the other supplementary worksheet to calculate the appropriate rates given the utility and rate defined by the user for the technology. For the residential rate it was possible to preserve the calculations without degrading the speed of the system.

Adoptions

The Adoptions box in the figure above represents a single workbook that supplies adoptions data to the results workbook upon completion of each batch run. Adoptions in this workbook have been defined for every combination of technologies possible. The adoptions are defined annually and span from 2007 through 2020.

Calculation Engine with Technology Level Results Installed

As mentioned earlier, each of the items in Figure 3-2 represent workbooks. The Calculation Engine oval is no exception. This item represents the workbook that does all the work. Most of the workbooks just described are inputs to this workbook. The code that runs when the user starts the batch processor opens these input workbooks, copies their data, and pastes them into the Calculation Engine. Once this process is complete the calculation engine loops over 2007 through 2020 and generates all the data needed to calculate the cost-effectiveness tests.

If the user so chooses, the technology-level results for each technology can be stored as a separate Calculation Engine workbook. These workbooks contain copies of all the inputs and all the calculated results for the technologies. The user can perform quality control on the individual technology level workbooks to determine the accuracy of the calculations and the accuracy of the results they produced. This level of detail is invaluable for developing confidence in the output of the system.

Program and Technology Level Results

The program-level results are stored in one or more workbooks per batch run. The results are stored in more than one workbook if the user chooses to store the results by utility, a selection that can be made when defining the run. If selected, a workbook is created for each utility selected. If, however, the user does not choose to segregate the results by utility then all results are stored in a single workbook.

The Results workbook consists of many worksheets. The cover sheet lists the user-defined global parameters. The adoption worksheet lists adoptions for all possible technology combinations. The Summary Stats Per Unit worksheet lists technologies included in the run and the per unit values of the benefit/cost test components. The Summary Stats Total worksheet combines the per unit level results with adoptions to aggregate the cost-effectiveness results by technology group, sector, and total. Finally, there are worksheets for each technology that was included in the batch run. These worksheets correspond directly to the Results worksheet found in the Calculation Engine workbook and are used by the Summary Stats Per Unit and the Summary Stats Total sheets to gather data for all technology combinations in the batch run.

3.2.4 Batch Processing

This segment presents a brief overview of the running a batch of technologies in the system. A more detailed discussion of this will be presented later in the User Guide.

Starting the System

The system is started by opening the SGIPce workbook. The worksheet presented when the workbook opens is used to define all aspects of the run. On this sheet the user defines the name of the run and the manner in which they would like the system to run (e.g., should it save all the Calculation Engines, should it update and replace results, etc.).

In the Technology Definitions table, the user selects from the complete *List of Technologies* the set of technologies they wish to include in the current run. To assist in managing the technology list there are a set of buttons to help clear and set flags and to reset data values that can be changed by the user from previous runs. Every possible combination of technology, utility, climate region, etc. is defined in this table. The user simply sets the *Run Technology Flag to Yes* and the line item will be included in the run. With all desired items selected and all controls appropriately set the user can move to the next step.

Running a Batch Job

With the current run defined there are three buttons available for starting the batch process. Essentially all three buttons produce the same end result. The buttons are designed to give the user a different experience while the batch run is executing. For example, if the user wants constant feedback during a run then they would use the *Batch Process View Screen Updating* button. If the user wants the run to go quickly and completely deal with the housekeeping of the workbooks then the *Batch Process No Screen Updating* button would be pressed. All three buttons lead to the same set of results being produced; the different types of batch runs simply impact the time to completion and the visual representation to the viewer while the process is running.

Implementing a batch run starts a process of opening workbooks, copying data, pasting data, running the model, and saving the results. The code underlying the SGIPce model is written in Visual Basic for Applications and can be viewed in the Visual Basic editor included as part of Excel 2007.

Viewing Calculation Engine and Results

If the user chooses to *Save Calc for each line*, upon completion of the run, the Calculation Engine and the Results from each run are stored in the appropriate workbook(s). If the user chose to not *Save Calc* for each line, upon completion of the run, the results from each run will be stored and the Calculation Engines will not be created. If the user chooses to *Store Results by*

Utility?, the results will be segregated by utility with a separate Results workbook being created for each utility defined in the run. If this option is not chosen, only one Results workbook is create to hold all the results from the batch run.

All Results workbooks are stored in the sub-directory named Results just below the SGIPce workbook. The user has the option to store the workbooks in other locations if they choose. They may rename the workbooks if so desired. The only way this is made available to the user, however, is when the *Batch Process View Screen Updating* button is pressed. The other two run buttons automatically save the results workbooks with their default names.

There is a control named *Update/Replace Results* on the opening screen in SGIPce. The purpose of this control is to tell the system to either completely replace any currently saved results with the new ones being run (*No*) or to update or replace results that currently exist (*Yes*). If set to *No* then the Results workbook is overwritten with a new one. If this control is set to *Yes*, however, the system treats results much differently. First the system looks to see if a Results workbook already exists with the same name as defined by the user for this run. If it does then the system opens that workbook as the data store for the current run. If it does not then it creates a new workbook for results. As the batch process proceeds and results are ready to be stored the system looks in the results workbook for previously stored results. If they exist then they are replaced. If they do not exist then they are added as a new worksheet. No results worksheets are deleted from the Results workbook when this flag is set. This feature can be used to fix existing results without the need of running the entire list of technologies and new technologies may be added again without the need of running the entire list of technologies as well.

4

Run Processor

4.1 Overview

This section of the User Guide will go into detail about the SGIPce workbook. This workbook is the front-end to the system. Whilst all the workbooks may be opened and viewed as desired, none of the other workbooks have macros or modules that will function correctly without this workbook being open and in control. It is also important to note that, when starting the system, this workbook is the workbook that must be opened first.

When the system starts, the SGIPce worksheet will be opened, as seen in Figure 4-1. It is this screen that controls the entire system processes. This section will go into detail about each of the components on this sheet and how to use them, and it will provide a more in-depth look than the Quick Start Guide.

Figure 4-1: SGIPce Opening Screen

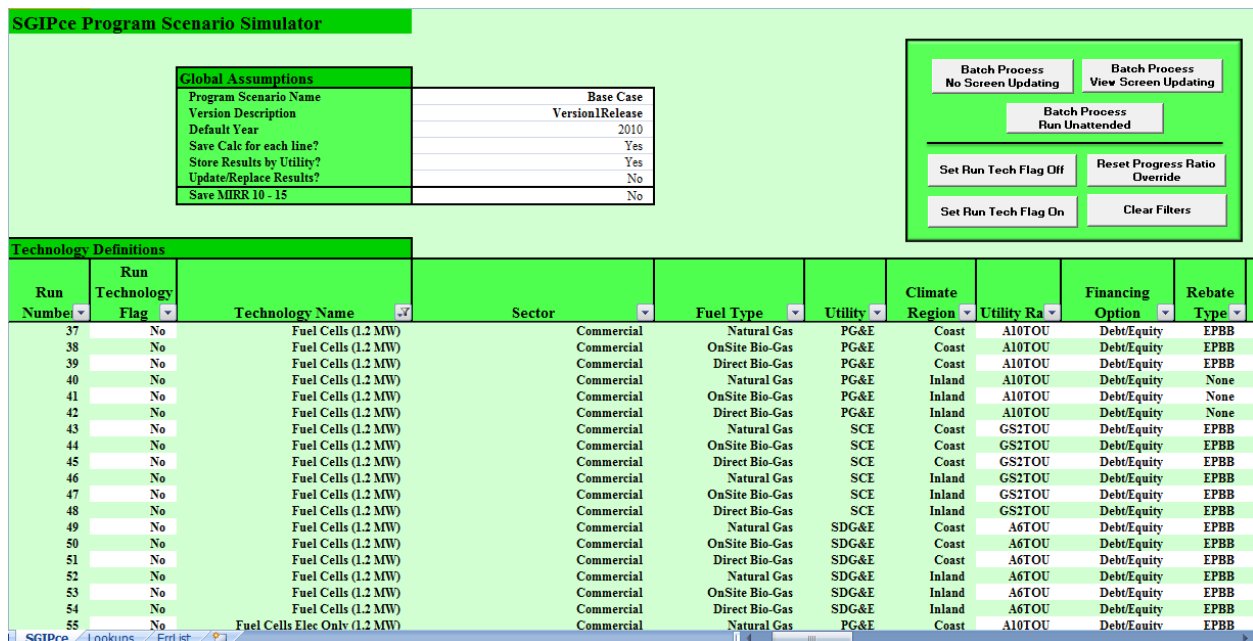

There are two other worksheets in this workbook: Lookups and ErrList. These worksheets will also be discussed in this section.

4.2 SGIPce Opening Screen

The worksheet named SGIPce, seen in Figure 4-1 above, is the opening sheet for the SGIPce system. Whenever this workbook is opened the user will automatically be presented with this worksheet. This section describes the three areas of interest on this worksheet.

4.2.1 Global Assumptions Table

The Global Assumptions table, found in the upper left corner of the screen, is the area where the user controls various aspects of how the system is going to function.

Figure 4-2: Global Assumptions

Global Assumptions	
Program Scenario Name	Base Case
Version Description	Version\Release
Default Year	2010
Save Calc for each line?	Yes
Store Results by Utility?	Yes
Update/Replace Results?	No
Save MIRR 10 - 15	No

Shown in Figure 4-2, the global assumptions table defines the following useful concepts.

- **Program Scenario Name** is a drop-down control that allows the user to change between the two specifically defined scenarios available in the system.
 - This control is used as one of two identifiers and identifies which scenario the stored workbooks were run under.
 - **The scenarios currently defined in the system are the *Base Case* and the *Greenhouse Gas (GHG)* scenarios.**
 - This identifier is used to help construct the default identifier for the Results workbook(s) and is used to build a sub-directory in the CalcEngines directory where the copies of the calculation engines are stored, if this option is selected by the user.
 - For example: *SGIPce_Results_BaseCase_TestVersion.xlsx* uses *Base Case* in the name as the scenario identifier for the Results workbook. This name implies a business as usual scenario.
 - The GHG scenario implies a scenario with higher GHG costs, higher avoided costs due to the GHG costs, and higher renewable energy credits (RECs).
- **Version Description** holds the name given by the user to identify the version of the scenario run defined using the program scenario name, which further defines the identifier used for the selected group of technologies.

- This is the second of the identifiers that is used to completely define the intent of the current selection of technologies and their corresponding parameters.
- This identifier is also used to help construct the default identifier for the Results workbook(s) and is used to build a sub-directory in the CalcEngines directory where the copies of the calculation engines are stored, if this option is selected by the user.
 - For example: *SGIPce_Results_BaseCase_TestVersion.xlsx* uses *TestVersion* in the name as the second user-defined identifier for the Results workbook. For this example, the name of the CalcEngines directory where the individual technology CalcEngines can be stored is BaseCase_TestVersion.
- **Default Year** sets the value of the default year to the year to which the Calculation Engine is set after the final period is calculated.
 - Note that all of the results presented in the copies of the Calculation Engine that are stored will be set to this year; hence, all the calculations, by default, will represent this year's values.
 - When the Calculation Engine is discussed in a later section it will be shown how this value can be changed when viewing the results to see how the results change over time.
 - This value should be set to a year that makes sense for the purposes of quality control. This is so that when the calculation engines are opened they are already setup for review.
 - When *Save MIRR...* is selected in SGIPce the LCOE worksheet is set to this value before the values of the rebates are found for the six MIRR calculations.
- **Save Calc for each line?** sets the control telling the system whether or not the user wants to save all the calculation engines, generated by the current batch run, in a separate folder for review.
 - If *No* is selected in this control then no Calculation Engine workbooks are saved and the system will run considerable faster.
 - If *Yes* is selected in this control then all the calculation engines will be stored in a sub-folder under the folder named CalcEngines.
 - The name of the folder, holding the CalcEngine files for the current batch run, corresponds to the values of the scenario and version controls mentioned above.
 - Note that the folder CalcEngines may be found in the folder where the user installed the SGIPce system.
 - ◆ This folder will be created automatically the first time the user runs the system and stores the calculation engines.

- Note that if the user has not changed the default identifiers for scenario and version then the Calculation Engines are being overwritten for each press of the button.
- **Store Results by Utility** allows the user to select how results are stored in the Results workbook(s).
 - If *No* is selected, then only one Results workbook is created.
 - This workbook will contain all the results from all the technology combinations selected for the batch run.
 - If this option is selected then the default workbook name will have a suffix “ALL” to represent that all utilities were placed into the same workbook.
 - If *Yes* is selected, then the results will be segregated into individual workbooks by utility.
 - There will be one Results workbook for each utility specified in the list of technology combinations selected by the user.
 - The current list of technologies contains entries for PG&E, SCE and SDG&E; hence, up to three workbooks may be created for a run. Each workbook will have a suffix that represents the utility for which the data are calculated.
- **Update/Replace Results** controls how data are stored into a Results workbook.
 - If *No* is selected, then all Results workbooks found having the same name as the name specified using the scenario and version controls will be replaced with the results from the current batch run.
 - If *Yes* is selected, then the following events will take place:
 - If no workbooks are found with the default names then they are created and the results are stored there.
 - If workbooks are found with the same default names then the following events happen for each technology combination in the batch run:
 - ◆ The workbooks are searched and if the technology combination is found then the results are updated to the values from the current run.
 - ◆ If the technology combination is not found then it is added to the list of technology combinations and included in the results.
 - ◆ Note that no technologies are deleted from the Results workbook during a batch run. If the user wants to remove a technology then they must do this manually.

- ◆ If the user has specified that they wish the results to be segregated by utility then each utility workbook is search individually and the results are treated as specified above.
 - ◆ If the user first specified that the results were to be stored together and then specifies to segregate the results then these are treated as separate runs and the Results workbooks will be separate.
- Note, that if the Calculation Engines are being stored and the user has not changed the default identifiers, then the Calculation Engines are being overwritten for each batch run.
- **Save MIRR 10-15** tells the system whether or not the user wants to run the code that finds the rebate in the default year that generates a Modified Internal Rate of Return (MIRR) at 10%, 11%, 12%, 13%, 14% & 15%.
- A new version of the Calculation Engine is saved to the drive for each of the six values.
 - *Note: This can take some time so it is suggested that this be done for a small set of technologies first to understand the workbooks that are saved and how they might be used.*

4.2.2 Technology Definitions Table

This is the table of all the possible technology combinations that may be run by the system. The user selects the line items they wish to include in the batch run and can change some of the values in the list to alter the definition of the technology to suit their particular scenario and version definition. This section will discuss each of the columns of this table in detail to give the user sufficient knowledge about the fields so that they can define runs efficiently within the system.

Table Column Definitions

Figure 4-3: Technology Definitions Table

Technology Definitions										
Run Number	Run Technology Flag	Technology Name	Sector	Fuel Type	Utility	Climate Region	Utility Rate	Financing Option	Rebate Type	
39	Yes	Fuel Cells (1.2 MW)	Commercial	Direct Bio-Gas	PG&E	Coast	A10TOU	Debt/Equity	EPBB	
40	No	Fuel Cells (1.2 MW)	Commercial	Natural Gas	PG&E	Inland	A10TOU	Debt/Equity	EPBB	
41	No	Fuel Cells (1.2 MW)	Commercial	OnSite Bio-Gas	PG&E	Inland	A10TOU	Debt/Equity	EPBB	
42	No	Fuel Cells (1.2 MW)	Commercial	Direct Bio-Gas	PG&E	Inland	A10TOU	Debt/Equity	EPBB	
43	No	Fuel Cells (1.2 MW)	Commercial	Natural Gas	SCE	Coast	GS2TOU	Debt/Equity	EPBB	
44	No	Fuel Cells (1.2 MW)	Commercial	OnSite Bio-Gas	SCE	Coast	GS2TOU	Debt/Equity	EPBB	
45	No	Fuel Cells (1.2 MW)	Commercial	Direct Bio-Gas	SCE	Coast	GS2TOU	Debt/Equity	EPBB	
46	No	Fuel Cells (1.2 MW)	Commercial	Natural Gas	SCE	Inland	GS2TOU	Debt/Equity	EPBB	
47	No	Fuel Cells (1.2 MW)	Commercial	OnSite Bio-Gas	SCE	Inland	GS2TOU	Debt/Equity	EPBB	
48	No	Fuel Cells (1.2 MW)	Commercial	Direct Bio-Gas	SCE	Inland	GS2TOU	Debt/Equity	EPBB	
49	No	Fuel Cells (1.2 MW)	Commercial	Natural Gas	SDG&E	Coast	A6TOU	Debt/Equity	EPBB	
50	No	Fuel Cells (1.2 MW)	Commercial	OnSite Bio-Gas	SDG&E	Coast	A6TOU	Debt/Equity	EPBB	
51	No	Fuel Cells (1.2 MW)	Commercial	Direct Bio-Gas	SDG&E	Coast	A6TOU	Debt/Equity	EPBB	
52	No	Fuel Cells (1.2 MW)	Commercial	Natural Gas	SDG&E	Inland	A6TOU	Debt/Equity	EPBB	
53	No	Fuel Cells (1.2 MW)	Commercial	OnSite Bio-Gas	SDG&E	Inland	A6TOU	Debt/Equity	EPBB	
54	No	Fuel Cells (1.2 MW)	Commercial	Direct Bio-Gas	SDG&E	Inland	A6TOU	Debt/Equity	EPBB	

In Figure 4-3 you can see a snippet of the table and its numerous columns. Following is a list of definitions for each column and how it may be used to specify alternative results for each line item.

Line Identifiers

- **Run Number** is a unique number used to identify each line item. This number is used in reporting results, identifying calculations, and identifying potential errors so that there is no confusion as to what line item generated what information.
 - This value can be found on all stored worksheets and workbooks on the cover page or at the top of the results page or in the Error Log uniquely identifying the technology.
 - These numbers should not be changed by the user.
- **Technology Name** is a description of the base technology for the line item.
 - A list of all technologies follow:
 - Gas Turbine (<= 2 MW)
 - Gas Turbine (>2-5 MW)
 - Fuel Cells (5 kW)
 - Fuel Cells (1.2 MW)Fuel Cells Electric (1.2 MW)
 - Micro Turbine (200 kW)
 - ICE (500 kW)
 - ICE (1.5 MW)
 - ORC (500 kW)
 - Wind (10 kW)
 - Wind (1 MW)
 - PVInland
 - PVCoast
 - Storage (1 MW)
 - Storage (25 kW)
 - These values are not to be changed by the user.
- **Sector** is an indicator as to which part of the population the current line item belongs.
 - This column can have three different values (i.e. Commercial, Residential, and Government/Non-Profit).
 - These values are not to be changed by the user.
- **Fuel Type** indicates the type of fuel used to power the technology on the current line.

- This column can have four different values (i.e. None, Natural Gas, On-site Bio-gas, Direct Bio-gas).
- There are four technologies that have None as their fuel type;
 - Wind, PV, ORC, Storage
- Fuel Cells 5kW are modeled as a residential technology that can only use natural gas.
- The balance of the technologies may be studied using Natural Gas, On-site Bio-gas, or Direct Bio-gas if desired.
- These values are not to be changed by the user.
- **Utility** indicates the utility for which the current line item is designed.
 - There are three utilities represented in the system (i.e. PG&E, SCE/SCG, SDG&E)
 - This column should be used to select the desired utility among those presented.
- **Climate Region** indicates the climate region assigned to the current line item.
 - The California standards climate zones have been reduced down to two areas (i.e. Coastal and Inland).
 - Section 3 shows a map of the distribution of weather stations by climate region.
 - These values are not to be changed by the user.

User Definable Fields

- **Run Technology Flag** is used to identify which technology combinations should be included in the defined batch run.
 - The user selects a technology by changing the value of this control to *Yes*.
 - A value of *No* deselects the technology for the current run.
 - The *Set Run Tech Flag Off* button clears the entire Run Technology Flag column by setting all values to *No*.
 - The *Set Run Tech Flag On* button sets to *Yes* the entire Run Technology Flag column.
 - Note that the cells are formatted with data validation. A drop-down is available to the user in each cell for selecting the value desired. Only acceptable values are presented in this drop-down.
- **Utility Rate** defines the electric rate to be assigned to the current line item.
 - Only the electric rates available for the utility and sector are selectable.
 - The electric rates available for selection are designed to be representative of the rates assigned to the majority of sites for the technology.

- A set of two rates have been defined for the residential sector and two for the non-residential sector for each utility.
- Note that the cells are formatted with data validation. A drop-down is available to the user in each cell for selecting the value desired. Only acceptable values are presented in this dropdown.
- **Financing Option** assigns the financing option to be used for the current line item.
 - There are two options available (i.e. Debt/Equity and PPA/Commercial)
 - *Debt/Equity* assumes that the technology will be financed using 60% equity and 40% debt.
 - *PPA/Commercial* assumes the technology is financed through a third party using a power purchase agreement. This option searches for the optimal financing distribution between debt and equity.
 - Choosing the PPA option has tax implications for the government/NP sector. The PPA allows the government/NP sector to use the tax advantages available to the commercial sector.
 - Choosing this option significantly slows the calculations.
 - Note that the cells are formatted with data validation. A drop-down is available to the user in each cell for selecting the value desired. Only acceptable values are presented in this dropdown.
- **Rebate Type** assigns the type of rebate to be paid to the site.
 - There are three options available (i.e. None, PBI, EPPB)
 - *None* – no rebate offered.
 - *PBI* – the five year rebate performance based incentive.
 - *EPBB* – the upfront rebate or the expected performance-based buydown.
 - Note that the cells are formatted with data validation. A drop-down is available to the user in each cell for selecting the value desired. Only acceptable values are presented in this dropdown.
 - The historical value of rebates is used for technologies from 2007-2010. The rebates from 2011 and beyond assumes that rebates will be maintained or reinstated for many technologies.
 - The value of the rebate cannot be changed in the technologies definitions table, only the type of rebate is chosen.
 - The value of the rebate is set in the technology workbook.
- **Progress Ratio** allows the user to override the default progress ratio used in the learning curve to determine the trajectory of technology cost for the current line item.

- If the user does not wish to change the default progress ratio then they should enter *NA* in this column.
 - The button labeled *Reset Progress Ratio Override* sets the entire column of values to *NA* when pressed.
- The default values for the progress ratio are available in the technology workbooks. The default values reflect currently available information on recent price changes and output production. If the user wishes to test alternative values for the progress ratio then they would enter a value in this column.
 - The number entered must be greater than zero and less than or equal to 1.
- **Technology Scenario Descriptor** is an identifier indicating the technology level scenario being studied.
 - Note that the cells are formatted with data validation. A drop-down is available to the user in each cell for selecting the value desired. Only acceptable values are presented in this dropdown.
 - Currently defined values for this field are as follows:
 - *NA* for no technology level scenario.
 - *CapFac* for a change in the Expected Capacity Factor.
 - *ProgRatio* for a change in the progress ration.
 - This field is used for identification on the cover page of the Calculation Engine only. It does not change the name of the technology in any way.
- **Expected Capacity Factor** may be used to adjust the production curves to represent a user-specified value for the capacity factor. The production curve is adjusted mathematically so that the average calculates to the specified value if possible.
 - The maximum allowable value for any given hour in the production function is 1.05.
 - The word “Actual” tells the program to used the assigned production function without adjustment.
- **Error Condition** identifies line items that are duplicates.
 - This error should not occur unless the user changes columns that are marked as “do not change” in this list.
 - If items are duplicated in the list then the aggregation routines will not distribute correctly the number of adoptions and will cause double counting. If the user confines themselves to the list as it is and only changes the columns with alternating colors then this error will not occur.
 - This column should not be changed by the user.

Filters

As can be seen in Figure 4-3 there are drop-down arrows that can be used to filter the rows that are visible to the user. This is available as a convenience to the user so that they may look at only the records important to them at the moment. The following are a list of concepts to note and points to make about the filters:

- Filtering the list does not limit the program to only run the visible line items.
 - If line items have the run flag set then they will be included in the batch run even if they are not visible.
 - Before starting a new scenario the user should make it a habit to press the *Set Run Tech Flag Off* button to clear the run flag for all records.
 - The *Clear Filters* button clears all the filters showing the entire list of technology combinations.
 - Before changing records or setting the run flag it would be a good idea to filter the list down as far as can be defined so that the list of items is short, manageable and pertinent to the analysis at hand.

4.2.3 The Button Box

There has been considerable mention of the buttons on the SGIPce worksheet in this section of the User Guide. The lower half of the box, seen in Figure 4-4 below, contains the buttons talked about in the previous section. These are the housekeeping buttons that help the user deal with setting values in the Technology Definitions table. The upper area of the box contains the macro buttons that cause the batch run to start. A description of all the buttons will be presented here.

Figure 4-4: The Button Box

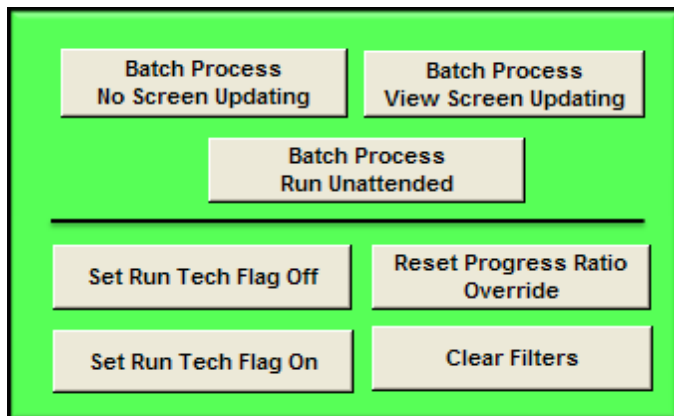

Table Housekeeping Buttons

Again, these are the buttons found in the lower half of the button box. They include the following:

- **Set Run Tech Flag Off** sets to *No* all cells in the column labeled Run Technology Flag.
- **Set Run Tech Flag On** sets to *Yes* all cells in the column labeled Run Technology Flag.
- **Reset Progress Ratio Override** sets to *NA* all cells in the column labeled Progress Ratio.
- **Clear Filters** clears all the filters set by the user in the Technology Definitions table.

It should be noted that these buttons work on all the cells whether or not the table is filtered.

Batch Process Buttons

These buttons all perform the same action: they run the macro that calculates the results for the technology combinations selected by the user in the Technology Definitions list. How they tell Excel 2007 to act while it runs the macro is the difference between these buttons. These differences are explained here.

- **Batch Process View Screen Updating** runs the macro allowing Excel to display all changes being made throughout code execution. The user will see all the workbooks open, all the data being copied, all the calculations being performed, and all the results being copied to the Results workbook.
 - The user will be asked to save the Results workbook(s) at the end of the batch run.
 - The user will be given the option of changing the name of the Results workbook from its default name, if desired.
 - The SGIPce workbook will remain open and will present to the user the worksheet named ErrList for review.
 - It is imperative that the user scroll through the entire list to see if there were any errors reported during the run. If errors occurred during a run then no results will be saved for that run and the Calculation Engine may not be saved.
- **Batch Process No Screen Updating** runs the macro with only occasional screen updating to allow the user to see where the run is at any time during the process. This allows for faster processing time, but does not give as much feedback to the user as the *View Screen Updating* option.
 - The Results workbook(s) will be saved automatically at the end of the batch run with the default name given to the workbooks created.
 - The SGIPce workbook will be saved and closed at the end of the run.

- Since SGIPce is closed automatically the user is not presented with the opportunity to review the error list at the end of the run. It is imperative, however, that the user opens the SGIPce workbook and review the ErrList worksheet at their earliest convenience. They should scroll through the entire list of entries to see if there were any *Errors* reported during the run. Errors are identified in the Type of Message column by the word *Error* and there will be an error number in the next column. If errors occurred during a run then no results will be saved for that run and the Calculation Engine may not be saved.
- **Batch Process Run Unattended** is a combination of the two previous buttons. It allows the user to watch the batch run progress if desired, but saves and closes all workbooks upon completion using the default names for all the Results workbooks.
 - This mode is somewhat slower than the *No Screen Updating* version because Excel has to redraw the screen continuously.
 - The Results workbook(s) will be save automatically at the end of the batch run with the default name given to the workbooks created.
 - The SGIPce workbook will be saved and closed at the end of the run.
- Since SGIPce is closed automatically the user is not presented with the opportunity to review the error list at the end of the run. It is imperative, however, that the user opens the SGIPce workbook and review the ErrList worksheet at their earliest convenience. They should scroll through the entire list of entries to see if there were any *Errors* reported during the run. Errors are identified in the Type of Message column by the word *Error* and there will be an error number in the next column. If errors occurred during a run then no results will be saved for that run and the Calculation Engine may not be saved.

4.3 Error List Worksheet

As part of the SGIPce workbook there is a worksheet called ErrList that holds information about the run just performed. Many of the entries in the worksheet are informational in nature. They show progress and time of execution to help with optimizing the runs and viewing where problems may have occurred. This worksheet also holds information about errors that may have occurred during the run, hence the name ErrList.

As mentioned previously, this list is very important to review at the end of a run. If the user finds that there are only entries in this list labeled *Information* then it can be assumed that the run was successful and the results are calculated as specified. If, however, the list contains lines identified with *Error* in the first column then those technologies must be reviewed and the errors resolved before the entire run can be considered complete.

Following is a description of each of the fields in the Error Log and how they may be interpreted.

- **Type of Message**

- *Information* indicates that the data on this line are for the user's information only. No error is indicated here.
- *Error* indicates that an error has occurred that needs to be addressed for the specified technology.

- **Error Number**

- *NA* indicates that there is not an error number. This value should only be seen on information lines.
- *<numeric value>*. This number can be searched for in the VBA code to determine where the error occurred. With this information, the developer can find the problem and make any necessary corrections to the code or inputs.
 - It is not advised that the user make changes to the code to solve a problem. If code is changed then the user's system is no longer compatible with the other versions and cannot be maintained by the developer.

- **Source** is additional information to help determine the origin of the problem causing the error. While the error might need to be worked on by the developer, the user can review the information in this and other fields to determine if an input error has occurred that they can fix.

- **Programmer Description** describes the area where the problem occurred in the code.

- **Error Description** is a more specific comment about the actual area of the code where the problem occurred.

- **Time/Date Stamp** is the value of the system clock at the time the error was reported.

- **Time Difference** is the difference in time between the current and previous entries. This is a good indicator of how long each run takes to complete.

Analyzing these codes can be very helpful in determining if an error has occurred due to a programming problem or to a problem with the data inputs. When reviewing the Error Log, the user should always ask, "What has changed since the last run?" as this helps identify the problem so that corrections can be made in a timely manner, thereby enabling a successful run.

Again, it is not advised that the user make changes to the code to solve a problem. Please contact the developer to discuss the problem and to obtain any code corrections made to the master workbooks.

4.4 Lookup Table

Lastly, in the SGIPce workbook there is a worksheet named Lookups. This worksheet is used by the program to translate names that are readable into names that are usable by the software. Changes to this table should never be made unless instructed by the developer.

4.5 Finally

This completes the description of the SGIPce workbook. As the controlling workbook, SGIPce is vital to the functioning of the system. There are many other components that make up the system and will be discussed in the following sections.

The next section will go into detail about the anatomy of the Calculation Engine. It will discuss how data come into the engine, how the engine calculates the results, and how the results are stored out to the Results workbook(s).

5

Calculation Engine

5.1 Overview

Presented in this section is a description of the workbook known as the Calculation Engine (Calc Engine). This workbook is where all the work is done with respect to setting up inputs, calculating values, and storing results. This section of the User Guide will discuss the process that is followed to do this work. It will talk about each of the worksheets (tabs) in the Calc Engine and how they interact, and it will also discuss the process of running the modules that do the work.

This workbook is not standalone. The workbook must have available the Run Processor discussed in the previous section. Because of this, the user generally does not interact with this workbook directly. As was discussed in the previous section, a copy of this workbook may be saved and reviewed during a batch run by setting “Save Calc for each line” to *Yes* in SGIPce. These standalone copies contain all the inputs used to calculate the results and all the results stored in the Results workbook for the technology it represents. These copies of the Calc Engine are what the user is more likely to find useful because they are populated with the data used for the run.

The rest of this section will walk through the workbook and discuss the tabs in some detail. Further detail will be provided in other sections to supplement the information presented here about the inputs and the results.

5.2 SGIPce Calculation Engine

As mentioned above the Calc Engine is a Microsoft Excel 2007 workbook, as are all the other workbooks associated with this system. The Calc Engine is unique in that most of the Visual Basic for Applications (VBA) code, run by the system, lives in this workbook. The code is never accessed by the user directly. The code is run when the user presses one of the buttons in the Run Processor discussed in Section Two. However, this workbook is the work horse of the system.

The following sections will go into detail about the structure of this workbook so the user can get around and find the pertinent information to review and analyze the data found here.

5.2.1 Calculation Engine, Tab by Tab

Cover Tab

The snapshot presented in Figure 5-1 shows the information presented on the cover page of the Calc Engine. The page gives the user information about the data that was used to generate the results to be found in the workbook. Figure 5-1 presents actual information from a run that was saved in a standalone version of the Calc Engine workbook for gas turbines.

The upper box shows the same information as can be seen in the run processor. These are the Global Assumptions that pertain to all technology runs performed as part of the batch process. The lower box shows the technology specific parameters that were used to define the inputs for the technology represented by the workbook. These data are exactly the same as the data found in the Technology Definitions table in the Run Processor for the line item being processed at the time.

Figure 5-1: Cover Tab

SGIPce Program Calculation Engine	
Global Assumptions	
Program Scenario Name	BaseCase
Version Description	Version1Release
Default Year	2010
Save Calc for each line?	Yes
Store Results by Utility?	No
Update/Replace Results?	No
Technology Definitions	
Run Number	39
Technology Name	Fuel Cells (1.2 MW)
Sector	Commercial
Fuel Type	Direct Bio-Gas
Utility	PG&E
Utility Rate	A10TOU
Climate Region	Coast
Financing Option	Debt/Equity
Rebate Type	EPBB
Progress Ratio Override	No Change
Technology Scenario Descriptor	NA
Technology Suffix	FC1200kW_NR_DIRBGas
Expected Capacity Factor	0.8

As can be seen in Figure 5-1, there are 12 items of information about the technology combination that is stored in the workbook. These items correspond to the columns in the Technology Definitions table. The Run Number is useful for identifying which line item the workbook represents. This is a unique number that is the first column in the Technology Definitions table. Definitions for each of the other 11 items can be found in Section 4 of this User Guide.

Results Tab

The Results tab is the second worksheet in the Calc Engine. A snapshot of this tab can be viewed in Figure 5-2. This is the location of the results stored during the iterative calculation process. The input parameters of the current run are presented at the top of the page for the convenience of the user. These are the same values as can be seen on the cover page.

Below that is a partial view of the results table where the cost-effectiveness calculations occur. These calculations are developed using the data generated by the Calc Engine as it iterates through the years of inputs supplied to it for the specific technology. The yearly values for the cost-effectiveness tests represent the life cycle value for the technology installed in the given year.

Figure 5-2: Results Tab

SGIPce Results										
	Run Number	39	Fuel Type	Direct Bio-Gas	CZ Region	Coast	Progress Ratio	No Change	Expected Cap Fac	0.8
	Tech Name	Fuel Cells (1.2 MW)	Utility	PG&E	Finance	Debt/Equity	Tech Scen	NA		
	Sector	Commercial	Rate	A10TOU	Rebate Type	EPBB	Tech Suffix	FC1200kW NR_DIRBGas		
Benefit/Cost Test Calculations	Discount Rate	Current Period	2007	2008	2009	2010	2011	2012	2013	2014
TRC										
TRC Benefits		\$1,584,840	\$1,465,823	\$1,488,111	\$1,547,029	\$1,584,840	\$1,617,808	\$1,651,566	\$1,687,254	\$1,723,687
TRC Costs		\$1,719,807	\$1,683,390	\$1,687,829	\$1,723,960	\$1,719,807	\$1,715,978	\$1,714,003	\$1,714,383	\$1,716,304
TRC Net Benefits		(\$134,967)	(\$217,567)	(\$199,719)	(\$176,931)	(\$134,967)	(\$98,169)	(\$62,438)	(\$27,128)	\$7,383
TRC Benefits Ratio		92.2%	87.1%	88.2%	89.7%	92.2%	94.3%	96.4%	98.4%	100.4%
TRC - Societal										
TRC - Societal Benefits		\$1,585,815	\$1,457,807	\$1,487,377	\$1,545,180	\$1,585,815	\$1,622,761	\$1,660,460	\$1,699,779	\$1,739,805
TRC - Societal Costs		\$1,632,667	\$1,584,205	\$1,594,979	\$1,630,591	\$1,632,667	\$1,635,177	\$1,639,360	\$1,645,577	\$1,653,198
TRC - Societal Net Benefits		(\$46,851)	(\$126,398)	(\$107,602)	(\$85,410)	(\$46,851)	(\$12,416)	\$21,100	\$54,202	\$86,607
TRC - Societal Benefits Ratio		97.1%	92.0%	93.3%	94.8%	97.1%	99.2%	101.3%	103.3%	105.2%
PCT										
PCT Benefits		\$2,176,437	\$2,071,055	\$2,093,683	\$2,159,844	\$2,176,437	\$2,194,683	\$2,215,327	\$2,238,763	\$2,265,088
PCT Costs		\$1,923,125	\$1,886,975	\$1,893,396	\$1,928,783	\$1,923,125	\$1,917,471	\$1,913,145	\$1,910,912	\$1,910,718
PCT Net Benefits		\$253,312	\$184,081	\$200,287	\$231,061	\$253,312	\$277,213	\$302,182	\$327,850	\$354,370
PCT Benefits Ratio		113.2%	109.8%	110.6%	112.0%	113.2%	114.5%	115.8%	117.2%	118.5%
PA										
PA Benefits		\$911,865	\$794,979	\$813,969	\$870,197	\$911,865	\$948,468	\$984,928	\$1,022,081	\$1,058,962
PA Costs		\$499,345	\$464,509	\$454,509	\$499,345	\$499,345	\$499,345	\$499,345	\$499,345	\$499,345
PA Net Benefits		\$412,521	\$330,470	\$359,460	\$370,852	\$412,521	\$449,123	\$485,583	\$522,737	\$559,618
PA Benefits Ratio		182.6%	174.9%	179.1%	174.3%	182.6%	189.9%	197.2%	204.7%	212.1%

A snippet of calculated results is presented in Figure 5-3 below. These results are developed through the iterative calculation process. The first two columns of data are labels identifying the source of the data in the LCOE ProForma tab. These values correspond to values found in that worksheet and are copied to their respective columns based on the period being calculated at the time. The column labeled Current Period contains links to the values in the LCOE tab. For each iteration of the macro the values are copied from the Current Period tab to the appropriate column based on the value of year. Upon completion of the calculations the values displayed in the Current Period column correspond to the default year set by the user in the Global Assumptions.

There are many more rows in this table. Each row in this table represents one of the calculated fields in the LCOE table. Figure 5-3 through Figure 5-7 show the values for the first six years of calculations of the data. The columns run from 2007 through to 2020 in the Results worksheet.

Figure 5-3: Results Tab (continued)

Levelized Lifetime Values	Discount Rate	Current Period	2007	2008	2009	2010	2011	2012
Levelized Cost of Generation (\$/kWh)		\$0.0538	\$0.06	\$0.06	\$0.05	\$0.05	\$0.05	\$0.05
% Financed w/ equity		60.00%	60.0%	60.0%	60.0%	60.0%	60.0%	60.0%
Upfront rebate	Participant	\$0	\$0	\$0	\$0	\$0	\$0	\$0
	Societal	\$0	\$0	\$0	\$0	\$0	\$0	\$0
	Utility	\$0	\$0	\$0	\$0	\$0	\$0	\$0
Cost of Generation (\$)	Participant	\$422,613	\$435,068	\$437,448	\$422,010	\$422,613	\$423,008	\$423,868
	Societal	\$418,788	\$431,131	\$433,489	\$418,191	\$418,788	\$419,180	\$420,033
	Utility	\$423,065	\$435,533	\$437,915	\$422,461	\$423,065	\$423,461	\$424,322
Operating Revenue	Participant	\$422,613	\$435,068	\$437,448	\$422,010	\$422,613	\$423,008	\$423,868
	Societal	\$418,788	\$431,131	\$433,489	\$418,191	\$418,788	\$419,180	\$420,033
	Utility	\$423,065	\$435,533	\$437,915	\$422,461	\$423,065	\$423,461	\$424,322
State Rebate	Participant	\$475,018	\$431,311	\$431,311	\$475,018	\$475,018	\$475,018	\$475,018
	Societal	\$380,457	\$345,451	\$345,451	\$380,457	\$380,457	\$380,457	\$380,457
	Utility	\$487,288	\$442,453	\$442,453	\$487,288	\$487,288	\$487,288	\$487,288
REC Revenue	Participant	\$197,223	\$197,223	\$197,223	\$197,223	\$197,223	\$197,223	\$197,223
	Societal	\$208,393	\$208,393	\$208,393	\$208,393	\$208,393	\$208,393	\$208,393
	Utility	\$195,788	\$195,788	\$195,788	\$195,788	\$195,788	\$195,788	\$195,788
Total Revenue	Participant	\$1,094,854	\$1,063,603	\$1,065,983	\$1,094,251	\$1,094,854	\$1,095,250	\$1,096,110
	Societal	\$1,007,638	\$984,975	\$987,333	\$1,007,041	\$1,007,638	\$1,008,030	\$1,008,883
	Utility	\$1,106,141	\$1,073,774	\$1,076,156	\$1,105,537	\$1,106,141	\$1,106,537	\$1,107,398
O&M Costs	Participant	(\$297,155)	(\$297,155)	(\$297,155)	(\$297,155)	(\$297,155)	(\$297,155)	(\$297,155)
	Societal	(\$302,717)	(\$302,717)	(\$302,717)	(\$302,717)	(\$302,717)	(\$302,717)	(\$302,717)
	Utility	(\$296,502)	(\$296,502)	(\$296,502)	(\$296,502)	(\$296,502)	(\$296,502)	(\$296,502)
Inverter Replacement Costs	Participant	\$0	\$0	\$0	\$0	\$0	\$0	\$0
	Societal	\$0	\$0	\$0	\$0	\$0	\$0	\$0
	Utility	\$0	\$0	\$0	\$0	\$0	\$0	\$0

Figure 5-4: Results Tab (continued)

Levelized Lifetime Values	Discount Rate	Current Period	2007	2008	2009	2010	2011	2012
Insurance Costs	Participant	(\$41,498)	(\$43,483)	(\$43,483)	(\$43,483)	(\$41,498)	(\$39,608)	(\$37,809)
	Societal	(\$42,275)	(\$44,297)	(\$44,297)	(\$44,297)	(\$42,275)	(\$40,350)	(\$38,517)
	Utility	(\$41,407)	(\$43,388)	(\$43,388)	(\$43,388)	(\$41,407)	(\$39,521)	(\$37,726)
Total Operating Costs	Participant	(\$1,060,887)	(\$1,001,592)	(\$1,008,566)	(\$1,037,397)	(\$1,060,887)	(\$1,083,229)	(\$1,105,483)
	Societal	(\$1,090,069)	(\$1,027,813)	(\$1,038,424)	(\$1,066,540)	(\$1,090,069)	(\$1,112,812)	(\$1,136,666)
	Utility	(\$1,057,463)	(\$998,533)	(\$1,005,038)	(\$1,033,969)	(\$1,057,463)	(\$1,079,763)	(\$1,101,951)
Operating Profit	Participant	\$33,967	\$62,012	\$57,417	\$56,854	\$33,967	\$12,021	(\$9,373)
	Societal	(\$82,431)	(\$42,838)	(\$51,091)	(\$59,499)	(\$82,431)	(\$104,782)	(\$126,783)
	Utility	\$48,678	\$75,241	\$71,118	\$71,568	\$48,678	\$26,774	\$5,447
Interest Expense	Participant	(\$141,026)	(\$147,772)	(\$147,772)	(\$147,772)	(\$141,026)	(\$134,603)	(\$128,488)
	Societal	(\$129,381)	(\$135,571)	(\$135,571)	(\$135,571)	(\$129,381)	(\$123,489)	(\$117,879)
	Utility	(\$142,388)	(\$149,199)	(\$149,199)	(\$149,199)	(\$142,388)	(\$135,902)	(\$129,728)
Loan Repayment Expense (Principal)	Participant	(\$140,802)	(\$147,537)	(\$147,537)	(\$147,537)	(\$140,802)	(\$134,389)	(\$128,284)
	Societal	(\$141,997)	(\$148,790)	(\$148,790)	(\$148,790)	(\$141,997)	(\$135,530)	(\$129,373)
	Utility	(\$140,577)	(\$147,302)	(\$147,302)	(\$147,302)	(\$140,577)	(\$134,175)	(\$128,079)
Debt Service Reserve	Participant	\$0	\$0	\$0	\$0	\$0	\$0	\$0
	Societal	\$0	\$0	\$0	\$0	\$0	\$0	\$0
	Utility	\$0	\$0	\$0	\$0	\$0	\$0	\$0
Interest earned on DSRF	Participant	\$0	\$0	\$0	\$0	\$0	\$0	\$0
	Societal	\$0	\$0	\$0	\$0	\$0	\$0	\$0
	Utility	\$0	\$0	\$0	\$0	\$0	\$0	\$0
Net Finance Costs	Participant	(\$281,828)	(\$295,310)	(\$295,310)	(\$295,310)	(\$281,828)	(\$268,992)	(\$256,772)
	Societal	(\$271,379)	(\$284,361)	(\$284,361)	(\$284,361)	(\$271,379)	(\$259,019)	(\$247,252)
	Utility	(\$282,965)	(\$296,501)	(\$296,501)	(\$296,501)	(\$282,965)	(\$270,077)	(\$257,807)
State tax refund/(paid)	Participant	\$140,932	\$138,780	\$139,396	\$141,945	\$140,932	\$139,965	\$139,132
	Societal	\$133,249	\$130,391	\$131,329	\$133,815	\$133,249	\$132,740	\$132,362
	Utility	\$141,902	\$139,837	\$140,412	\$142,970	\$141,902	\$140,880	\$139,991
Federal tax refund (paid)	Participant	\$514,070	\$529,811	\$532,037	\$525,938	\$514,070	\$502,763	\$492,313
	Societal	\$483,998	\$492,453	\$495,839	\$492,557	\$483,998	\$475,958	\$468,687
	Utility	\$517,903	\$534,575	\$536,651	\$530,189	\$517,903	\$506,184	\$495,332

Figure 5-5: Results Tab (continued)

Levelized Lifetime Values	Discount Rate	Current Period	2007	2008	2009	2010	2011	2012
Taxes Saved/(Paid)	Participant	\$655,002	\$668,591	\$671,433	\$667,883	\$655,002	\$642,729	\$631,445
	Societal	\$617,247	\$622,844	\$627,168	\$626,372	\$617,247	\$608,699	\$601,050
	Utility	\$659,806	\$674,413	\$677,063	\$673,159	\$659,806	\$647,064	\$635,324
Equity Investment	Participant	(\$438,664)	(\$459,648)	(\$459,648)	(\$459,648)	(\$438,664)	(\$418,685)	(\$399,664)
	Societal	(\$340,986)	(\$357,298)	(\$357,298)	(\$357,298)	(\$340,986)	(\$325,456)	(\$310,671)
	Utility	(\$451,658)	(\$473,264)	(\$473,264)	(\$473,264)	(\$451,658)	(\$431,087)	(\$411,503)
After-Tax Equity Cash Flow	Participant	(\$31,522)	(\$24,355)	(\$26,108)	(\$30,221)	(\$31,522)	(\$32,927)	(\$34,364)
	Societal	(\$77,549)	(\$61,652)	(\$65,582)	(\$74,786)	(\$77,549)	(\$80,558)	(\$83,656)
	Utility	(\$26,139)	(\$20,111)	(\$21,583)	(\$25,038)	(\$26,139)	(\$27,326)	(\$28,540)
Levelized Average Avoided Cost Rate Elec	Participant	\$914,847	\$798,032	\$817,539	\$873,292	\$914,847	\$951,466	\$987,950
	Societal	\$940,150	\$823,973	\$847,372	\$899,454	\$940,150	\$976,888	\$1,013,531
	Utility	\$911,865	\$794,979	\$813,969	\$870,197	\$911,865	\$948,468	\$984,928
Levelized Average Avoided Cost Rate Elec Charging	Participant	\$0	\$0	\$0	\$0	\$0	\$0	\$0
	Societal	\$0	\$0	\$0	\$0	\$0	\$0	\$0
	Utility	\$0	\$0	\$0	\$0	\$0	\$0	\$0
Levelized Average Avoided Cost Rate Gas Required	Participant	\$521,081	\$475,985	\$472,215	\$498,579	\$521,081	\$541,578	\$561,635
	Societal	\$538,846	\$489,860	\$491,117	\$516,474	\$538,846	\$559,704	\$580,360
	Utility	\$519,000	\$474,390	\$469,969	\$496,471	\$519,000	\$539,460	\$559,451
Levelized Average Avoided Cost Rate Gas Out	Participant	\$155,764	\$136,796	\$138,197	\$147,330	\$155,764	\$163,866	\$172,033
	Societal	\$161,667	\$141,380	\$144,166	\$153,168	\$161,667	\$169,915	\$178,241
	Utility	\$155,072	\$136,268	\$137,491	\$146,643	\$155,072	\$163,157	\$171,306
Levelized Average Avoided Cost Rate Gas Required PA test only	Participant	\$0	\$0	\$0	\$0	\$0	\$0	\$0
	Societal	\$0	\$0	\$0	\$0	\$0	\$0	\$0
	Utility	\$0	\$0	\$0	\$0	\$0	\$0	\$0
Levelized Average Avoided Cost Rate Gas Out PA test only	Participant	\$0	\$0	\$0	\$0	\$0	\$0	\$0
	Societal	\$0	\$0	\$0	\$0	\$0	\$0	\$0
	Utility	\$0	\$0	\$0	\$0	\$0	\$0	\$0

Figure 5-6: Results Tab (continued)

Levelized Lifetime Values	Discount Rate	Current Period	2007	2008	2009	2010	2011	2012
Levelized Elec Bill Savings (\$)	Participant	\$765,203	\$696,647	\$716,761	\$738,880	\$765,203	\$792,868	\$822,033
	Societal	\$784,682	\$711,761	\$733,557	\$757,298	\$784,682	\$813,425	\$843,659
	Utility	\$762,930	\$694,903	\$714,812	\$736,733	\$762,930	\$790,466	\$819,504
Levelized Gas Bill Increase (\$)	Participant	\$863,980	\$791,378	\$797,800	\$833,186	\$863,980	\$893,031	\$921,746
	Societal	\$889,504	\$813,362	\$824,474	\$858,758	\$889,504	\$918,979	\$948,374
	Utility	\$860,984	\$788,821	\$794,636	\$830,173	\$860,984	\$889,992	\$918,631
Levelized Gas Bill Savings (\$)	Participant	\$83,990	\$77,282	\$76,954	\$80,839	\$83,990	\$86,846	\$89,608
	Societal	\$85,579	\$78,550	\$78,846	\$82,501	\$85,579	\$88,427	\$91,217
	Utility	\$83,803	\$77,136	\$76,727	\$80,641	\$83,803	\$86,660	\$89,419
Levelized Charging Cost (\$)	Participant	\$0	\$0	\$0	\$0	\$0	\$0	\$0
	Societal	\$0	\$0	\$0	\$0	\$0	\$0	\$0
	Utility	\$0	\$0	\$0	\$0	\$0	\$0	\$0
Levelized Emissions Factors - CO (\$)	Participant	\$114,496	\$86,002	\$94,746	\$104,230	\$114,496	\$125,349	\$136,798
	Societal	\$124,250	\$94,135	\$103,449	\$113,477	\$124,250	\$135,461	\$147,103
	Utility	\$113,354	\$85,056	\$93,731	\$103,149	\$113,354	\$124,162	\$135,585
Levelized Emissions Factors - NOx (\$)	Participant	\$2,889	\$2,251	\$2,439	\$2,651	\$2,889	\$3,136	\$3,398
	Societal	\$3,108	\$2,431	\$2,635	\$2,860	\$3,108	\$3,365	\$3,636
	Utility	\$2,863	\$2,230	\$2,416	\$2,627	\$2,863	\$3,110	\$3,370
Levelized Emissions Factors - PM10 (\$)	Participant	\$2	\$2	\$2	\$2	\$2	\$2	\$3
	Societal	\$3	\$2	\$2	\$2	\$3	\$3	\$3
	Utility	\$2	\$2	\$2	\$2	\$2	\$2	\$3
Levelized Admin Costs (\$/kW)	Participant	\$11,710	\$11,710	\$11,710	\$11,710	\$11,710	\$11,710	\$11,710
	Societal	\$9,102	\$9,102	\$9,102	\$9,102	\$9,102	\$9,102	\$9,102
	Utility	\$12,057	\$12,057	\$12,057	\$12,057	\$12,057	\$12,057	\$12,057
Levelized Admin Costs (\$/unit)	Participant	\$0	\$0	\$0	\$0	\$0	\$0	\$0
	Societal	\$0	\$0	\$0	\$0	\$0	\$0	\$0
	Utility	\$0	\$0	\$0	\$0	\$0	\$0	\$0
NPV Upfront Rebate	Participant	\$0	\$0	\$0	\$0	\$0	\$0	\$0
	Societal	\$0	\$0	\$0	\$0	\$0	\$0	\$0
	Utility	\$0	\$0	\$0	\$0	\$0	\$0	\$0
NPV State Rebate	Participant	\$4,578,291	\$4,157,044	\$4,157,044	\$4,578,291	\$4,578,291	\$4,578,291	\$4,578,291
	Societal	\$4,717,304	\$4,283,267	\$4,283,267	\$4,717,304	\$4,717,304	\$4,717,304	\$4,717,304
	Utility	\$4,561,436	\$4,141,740	\$4,141,740	\$4,561,436	\$4,561,436	\$4,561,436	\$4,561,436

Figure 5-7: Results Tab (continued)

Levelized Lifetime Values	Discount Rate	Current Period	2007	2008	2009	2010	2011	2012
Total Rebate (Debt/Equity Only)	Participant	\$475,018	\$431,311	\$431,311	\$475,018	\$475,018	\$475,018	\$475,018
	Societal	\$380,457	\$345,451	\$345,451	\$380,457	\$380,457	\$380,457	\$380,457
	Utility	\$487,288	\$442,453	\$442,453	\$487,288	\$487,288	\$487,288	\$487,288
REC Revenue (Debt/Equity Only)	Participant	\$197,223	\$197,223	\$197,223	\$197,223	\$197,223	\$197,223	\$197,223
	Societal	\$208,393	\$208,393	\$208,393	\$208,393	\$208,393	\$208,393	\$208,393
	Utility	\$195,788	\$195,788	\$195,788	\$195,788	\$195,788	\$195,788	\$195,788
State tax refund/(paid) (Debt/Equity Only)	Participant	\$140,932	\$138,780	\$139,396	\$141,945	\$140,932	\$139,965	\$139,132
	Societal	\$133,249	\$130,391	\$131,329	\$133,815	\$133,249	\$132,740	\$132,362
	Utility	\$141,902	\$139,837	\$140,412	\$142,970	\$141,902	\$140,880	\$139,991
Federal tax refund (paid) (Debt/Equity Only)	Participant	\$514,070	\$529,811	\$532,037	\$525,938	\$514,070	\$502,763	\$492,313
	Societal	\$483,998	\$492,453	\$495,839	\$492,557	\$483,998	\$475,958	\$468,687
	Utility	\$517,903	\$534,575	\$536,651	\$530,189	\$517,903	\$506,184	\$495,332
Total Rebate (Debt/Equity Only)	Participant	\$1,327,243	\$1,297,126	\$1,299,968	\$1,340,125	\$1,327,243	\$1,314,970	\$1,303,686
	Societal	\$1,206,097	\$1,176,689	\$1,181,012	\$1,215,222	\$1,206,097	\$1,197,548	\$1,189,899
	Utility	\$1,342,881	\$1,312,654	\$1,315,304	\$1,356,235	\$1,342,881	\$1,330,140	\$1,318,400
Less System Cost (PPA Only)	Participant	\$0.00	\$0	\$0	\$0	\$0	\$0	\$0
	Societal	\$0.00	\$0	\$0	\$0	\$0	\$0	\$0
	Utility	\$0.00	\$0	\$0	\$0	\$0	\$0	\$0

To the right of the cost test calculations are graphs and table representing the calculated values of these tests. Figure 5-8 shows an example graphic showing the trend in the benefit/cost ratios from the current technology. Figure 5-9 and Figure 5-10 show graphically and numerically the calculated values of all the inputs to the benefit/cost ratio calculations.

Figure 5-8: Benefit/Cost Ratio Graphic

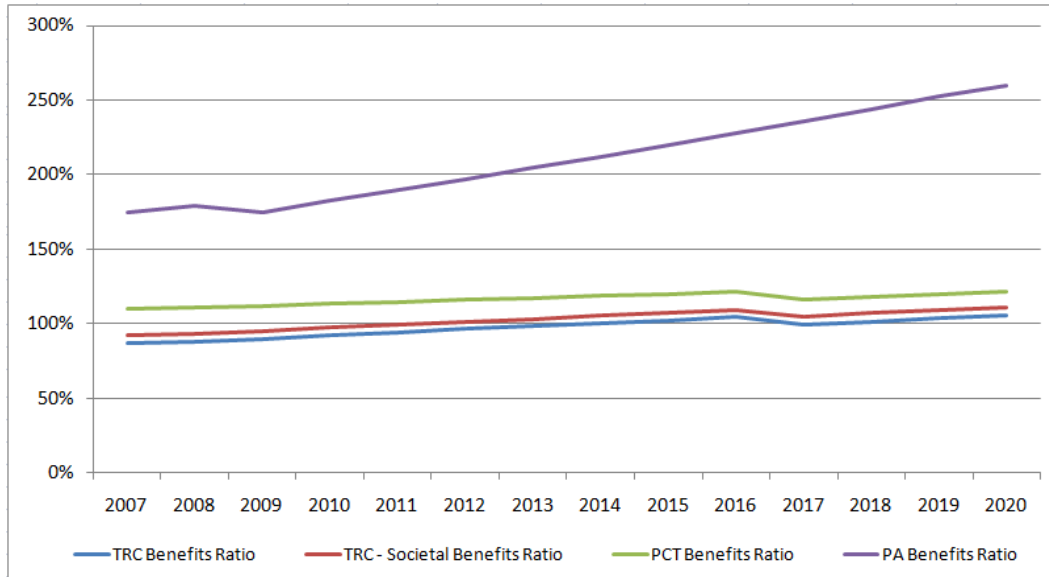

The following tests are calculated for each technology:

- PCT – Participant Cost
- PA – Program Administrator
- NatTRC – Natural Total Resource Cost
- TRC – Total Resource Cost
- STRC – Societal Resource Cost

Figure 5-9 and Figure 5-10 show results for the year 2010. There is a second table and chart on this worksheet that show the results for the year 2015. These years were selected as the default years to display but they are user definable. In Figure 5-9 below note that 2010 is highlighted in yellow and red. This indicates that the user may select a different value of year for the table and hence the chart. When changed the table will update to the new year and the chart will follow. Note that only values between 2007 and 2020 are allowed in this field. Other values will cause an error. Also, both tables are user-definable.

Figure 5-9: Benefit/Cost Test Tables

Cost Tests	PCT		PA		NatTRC		TRC		STRC	
	Benefit	Cost	Benefit	Cost	Benefit	Cost	Benefit	Cost	Benefit	Cost
System Cost		\$ 720,492				\$ 612,365		\$ 734,623		\$ 612,365
Total Rebate	\$ 475,018			\$ 487,288						
REC Revenue	\$ 197,223									
State Taxes	\$ 140,932									
Federal Taxes	\$ 514,070						\$ 517,903		\$ 483,998	
Program Admin				\$ 12,057		\$ 9,102		\$ 12,057		\$ 9,102
Avoided Cost			\$ 911,865		\$ 1,101,817		\$ 1,066,937		\$ 1,101,817	
Avoided Bills	\$ 849,194									
O&M Cost		\$ 338,653				\$ 344,992		\$ 337,909		\$ 344,992
Fueling Cost		\$ 863,980				\$ 538,846		\$ 519,000		\$ 538,846
Emissions					\$ -	\$ 127,361	\$ -	\$ 116,220	\$ -	\$ 127,361
Total	\$2,176,437	\$1,923,125	\$ 911,865	\$499,345	\$1,101,817	\$1,632,667	\$1,584,840	\$1,719,807	\$1,585,815	\$1,632,667
Net Benefit		\$ 253,312		\$412,521		\$ (530,850)		\$ (134,967)		\$ (46,851)
Ratio		1.13		1.83		0.67		0.92		0.97

Figure 5-10: Benefit/Cost Test Chart

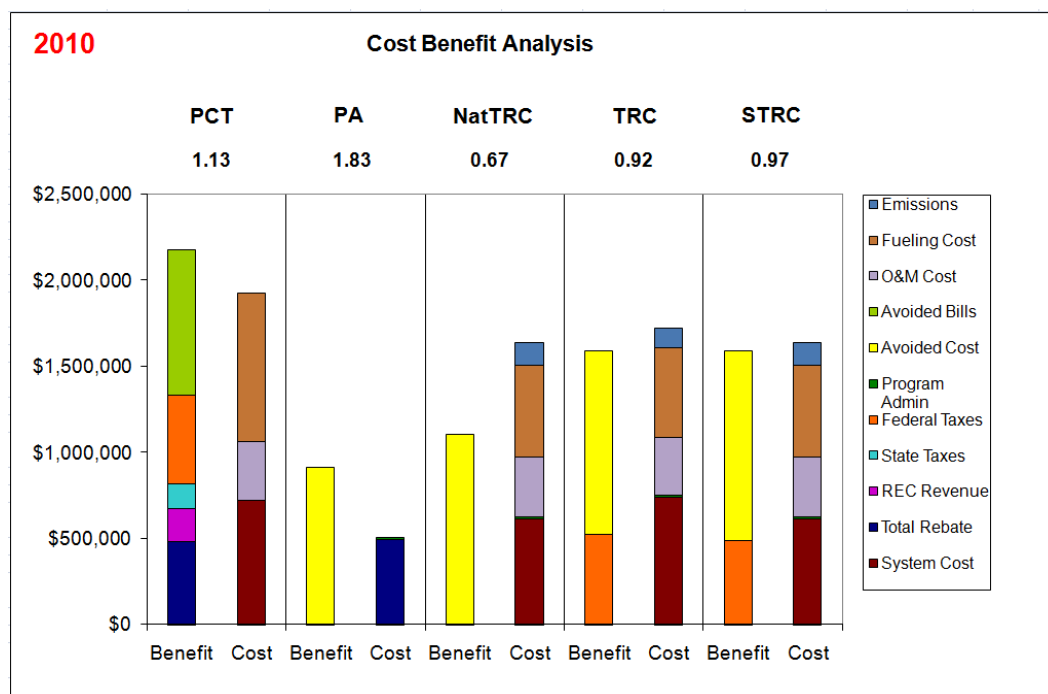

LCOE ProForma Tab

The LCOE ProForma tab has its roots in the E3 CSI ProForma model discussed earlier in this User Guide. The spirit of the E3 model lives in this worksheet and the Inputs worksheet, discussed next.

In Figure 5-11 a snippet of the worksheet is presented showing the standard E3 format for this sheet. The upper part of the sheet contains the current period values of the inputs and shows the calculation of the *Levelized Cost of Generation* as an output on the right part of the figure. The VBA code changes the period for each iteration of the run which in turn updates the values in the upper table. These new values feed through the lower part of the worksheet to calculate the

results that are then copied to the Results workbook described above. This is done repeatedly until the calculations are performed for 2007 through 2020 and the results copied.¹

Figure 5-11: LCOE ProForma Tab

Change Default Year		2010									
System Design				Tax Assumptions				Financing			
System Cost per Watt (\$/Watt AC/DC) (ALL IN)	5.872093679	Tech		Federal Tax Rate	35.00%	Global-Sector	% Financed w/ equity	60%			
System Size (Design) (kW AC/DC)	1200	Tech		State Tax Rate	8.84%	Global-Sector	% Financed w/ debt	40%			
Initial debt service reserve funding	\$0.00000	Calc		Effective Tax Rate	40.75%	Global-Sector	Debt Interest rate	7.67%			
Upfront rebate reduction	\$0	Calc		Taxable electricity	0	Calc	Debt period in years	16			
Total System Cost	\$7,046,512	Calc		Taxable PBI Incentive (Federally) (1=yes,0=no)	1	Calc	Year Debt Placed	1			
Performance Inputs				Federal Tax Credit				Output			
System Size Derate Factor	1.00	Tech		Total System Cost	\$7,046,512	Calc	Cost of Equity	10.72%			
System Size (Performance) (kW AC)	1,200	Calc		Tax Credit Rate	30%	Tech	WACC	8.25%			
Annual Net AC Capacity Factor	80.0%	Tech		Tax Credit Amount	\$2,113,954	Calc	Interest Rate on DSRF	3.8%			
Annual Output for Year 1 (kWh)	8,409,600		8,409,600	Tax Savings through Depreciation				PPA Escalator			
Degradation Factor	1.00%	Tech		Full Basis Amount	\$7,046,512	Calc	Equity Amount	\$4,227,907			
System lifetime (in Years)	20.00	Tech		Basis Reduction (50% of ITC)	15%	Calc	Debt Amount	\$2,818,605			
Other				State Rebate				EPBB			
O&M Costs (\$/kWh)	\$0.0300	Tech		Depreciation Basis	\$5,989,536	Calc	Program Admin Cost (\$/kW)	\$94.05			
O&M Costs Escalator (%/Yr)	2.00%	Global		MACRS Term	5	Tech	Program Admin Cost (\$/unit)	\$0.00			
Partial Equip Replacement Cost (\$/W)	\$0.00	Tech		EPBB				Levelized Cost of Generation (\$/kWh)			
Partial Equip replacement time (in Years)	1	Tech		PBI	No		Levelized Cost of Generation (\$/kWh)	\$0.0538			
Partial Equip replacement cost	\$0.00	Calc?		Rebate Amount (\$/kWh)	\$0.15		NPV	\$0.00			
Levelized (1/yr) Partial Equip replacement cost	-	Calc?		EPBB - Upfront	Yes		REC Start Year	2013			
Insurance Expense Multiplier (%)	0.5%	Tech		Rebate Amount Per Watt AC	\$4.13		Number of years rebated	5			
Insurance Escalator (%/Yr)	2.00%	Tech		CEC-AC Rating	1,200.0	Calc	Inflation Rate	2%			
REC price (\$/kWh)	\$0.035	Tech		CSI Rating (=CEC-AC * Design Factor)	1,200.0	Calc	Years of Debt Service in DSRF	1			
REC price escalator (%/Yr)	0.00%	Tech		Total Upfront Rebate Amount	\$4,956,000	Calc	Target DSCR	1.40			
REC price multiplier (1.0)	1	Tech						Reinvestment Rate	10.72%		
								Design Derate Factor	100.00%		

Inputs Tab

This tab is used to aggregate many of the inputs into one place so that they can be reviewed as a group and can be referenced on the LCOE worksheet to perform the iterations. In Figure 5-12 the user can see the list of fields that correspond to the upper portion of the LCOE tab. These values are retrieved based on the chronologic order of the columns. As the iterations progress the data retrieved from this table moves one column over for each period.

Column A of this table gives a brief description of the data item. Column B of the table shows the source of the data (i.e., the tab from which the data are retrieved). Columns C through P are the data used in the model starting in 2007 and running through 2020.

¹ The LCOE worksheet presents the economics over the life of a technology for a given year's installation. This differs significantly from the information presented on the Results worksheet. The Results tab presents, for each year, the lifecycle value of costs and benefits. Whereas the LCOE workbook presents the economics for a piece of technology over its lifecycle, the Results tab presents the lifecycle economics for technologies installed from 2007-2020.

Figure 5-12: Input Tab

DG Inputs															
Inputs (Iron_wInputTable)															
Note: all values in this table are obtained from other input tabs in this workbook.															
System Price		2007	2008	2009	2010	2011	2012	2013	2014	2015	2016	2017	2018	2019	2020
Measure Price (\$/M)	Tech/Annual	\$5.01	\$5.01	\$5.01	\$5.73	\$5.45	\$5.20	\$4.95	\$4.72	\$4.50	\$4.28	\$4.06	\$3.83	\$3.70	\$3.53
Inverter Price (\$/M)	Tech/Annual	\$0.00	\$0.00	\$0.00	\$0.00	\$0.00	\$0.00	\$0.00	\$0.00	\$0.00	\$0.00	\$0.00	\$0.00	\$0.00	\$0.00
Other Costs (\$/M)	Tech/Annual	\$0.14	\$0.14	\$0.14	\$0.15	\$0.15	\$0.15	\$0.16	\$0.16	\$0.16	\$0.17	\$0.17	\$0.17	\$0.18	\$0.18
System Cost per kWatt	Calc	\$5.15	\$5.15	\$5.15	\$5.87	\$5.60	\$5.35	\$5.11	\$4.88	\$4.66	\$4.45	\$4.23	\$4.00	\$3.89	\$3.77
Performance Inputs															
Annual Net Capacity Factor	Tech/Const	80%	80%	80%	80%	80%	80%	80%	80%	80%	80%	80%	80%	80%	80%
System lifetime (Years)	Tech/Const	20	20	20	20	20	20	20	20	20	20	20	20	20	20
Degradation Factor (%/yr)	Tech/Const	1%	1%	1%	1%	1%	1%	1%	1%	1%	1%	1%	1%	1%	1%
DC to AC derate factor	Tech/Const	100%	100%	100%	100%	100%	100%	100%	100%	100%	100%	100%	100%	100%	100%
Cost Inputs															
O&M Costs (\$/kW)	Tech/Annual	\$0.03	\$0.03	\$0.03	\$0.03	\$0.03	\$0.03	\$0.03	\$0.03	\$0.03	\$0.03	\$0.03	\$0.03	\$0.03	\$0.03
O&M Cost Escalator (%/yr)	Global	2.00%	2.00%	2.00%	2.00%	2.00%	2.00%	2.00%	2.00%	2.00%	2.00%	2.00%	2.00%	2.00%	2.00%
Partial Equip replacement costs (\$/M)	Tech/Annual	\$0.00	\$0.00	\$0.00	\$0.00	\$0.00	\$0.00	\$0.00	\$0.00	\$0.00	\$0.00	\$0.00	\$0.00	\$0.00	\$0.00
Partial Equip replacement time (Years)	Tech/Const	1	1	1	1	1	1	1	1	1	1	1	1	1	1
Insurance Expense Multiplier (%)	Global	0.5%	0.5%	0.5%	0.5%	0.5%	0.5%	0.5%	0.5%	0.5%	0.5%	0.5%	0.5%	0.5%	0.5%
Insurance Escalator (%/yr)	Global	2.00%	2.00%	2.00%	2.00%	2.00%	2.00%	2.00%	2.00%	2.00%	2.00%	2.00%	2.00%	2.00%	2.00%
REC price (\$/M)	Tech	\$ 0.035	\$ 0.035	\$ 0.035	\$ 0.035	\$ 0.035	\$ 0.035	\$ 0.035	\$ 0.035	\$ 0.035	\$ 0.035	\$ 0.035	\$ 0.035	\$ 0.035	\$ 0.035
REC price escalator (%/yr)	Tech	0%	0%	0%	0%	0%	0%	0%	0%	0%	0%	0%	0%	0%	0%
REC price multiplier	Tech/Global?	1	1	1	1	1	1	1	1	1	1	1	1	1	1
Finance Inputs															
Federal Tax Rate	Finance	35%	35%	35%	35%	35%	35%	35%	35%	35%	35%	35%	35%	35%	35%
State Tax Rate	Finance	3%	3%	3%	3%	3%	3%	3%	3%	3%	3%	3%	3%	3%	3%
Tax Credit Rate	Tech	30%	30%	30%	30%	30%	30%	30%	30%	30%	30%	30%	30%	30%	30%
Percent financed with Equity	Finance	60%	60%	60%	60%	60%	60%	60%	60%	60%	60%	60%	60%	60%	60%
Debt Interest Rate	Finance	8%	8%	8%	8%	8%	8%	8%	8%	8%	8%	8%	8%	8%	8%
Target DSCR	Finance	140%	140%	140%	140%	140%	140%	140%	140%	140%	140%	140%	140%	140%	140%
Years of Debt Service in DSRF	Finance	1	1	1	1	1	1	1	1	1	1	1	1	1	1
WACC	Finance	8%	8%	8%	8%	8%	8%	8%	8%	8%	8%	8%	8%	8%	8%
Cost of Equity	Finance	11%	11%	11%	11%	11%	11%	11%	11%	11%	11%	11%	11%	11%	11%
Rates															
Retail rate (\$/kWh)	Rates	\$0.14	\$0.13	\$0.13	\$0.12	\$0.13	\$0.13	\$0.14	\$0.14	\$0.14	\$0.15	\$0.16	\$0.16	\$0.17	\$0.17
PEI Avg Rebate Amount (\$/kWh)	Tech/Annual	\$0.13	\$0.13	\$0.15	\$0.15	\$0.15	\$0.15	\$0.15	\$0.15	\$0.15	\$0.15	\$0.15	\$0.15	\$0.15	\$0.15
EPES Avg Rebate amount (\$/M)	Tech/Annual	\$3.75	\$3.75	\$4.13	\$4.13	\$4.13	\$4.13	\$4.13	\$4.13	\$4.13	\$4.13	\$4.13	\$4.13	\$4.13	\$4.13
Inflation Rate (%/yr)	Global/Annual	2.00%	2.00%	2.00%	2.00%	2.00%	2.00%	2.00%	2.00%	2.00%	2.00%	2.00%	2.00%	2.00%	2.00%
Program Administrative Costs (\$/unit)	Tech	\$0.00	\$0.00	\$0.00	\$0.00	\$0.00	\$0.00	\$0.00	\$0.00	\$0.00	\$0.00	\$0.00	\$0.00	\$0.00	\$0.00
Program Administrative Costs (\$/kW)	Tech	\$34.05	\$34.05	\$34.05	\$34.05	\$34.05	\$34.05	\$34.05	\$34.05	\$34.05	\$34.05	\$34.05	\$34.05	\$34.05	\$34.05
Program Admin Cost Escalator (%/yr)	Tech	0.00%	0.00%	0.00%	0.00%	0.00%	0.00%	0.00%	0.00%	0.00%	0.00%	0.00%	0.00%	0.00%	0.00%
Apply Tax Credit	Finance	1	1	1	1	1	1	1	1	1	1	1	1	1	1

Technology Tab

The Technology tab, shown in Figure 5-13, contains the constant values from the currently selected technology workbook. The values in this workbook do not change over time. Each technology workbook contains a corresponding Constants table holding most of these data. The macro that runs retrieves these data and places them in the Technology Level Constants table for use by the Calc Engine. The four values with the prefix *Annual* are retrieved from the TechnologyProduction tab, also found in the technology workbook. In the case of Annual Electric Charging, this field is only populated in the Storage technology workbooks.

As can be seen in the figures, there is a color-coding convention. The orange-colored cells are cells that receive data from another resource, the technology workbook. The blue-colored cells are calculated values from the data obtained from the technology workbook. Grey areas are not used by the system at this time. All of the orange cells are overwritten each time the system iterates to a new technology combination. The color-coding convention will follow through all the remaining Input tabs in the Calc Engine.

Figure 5-13: Technology Tab

Technology Level Constants		
Inputs by Tech	Value	Comments
Degradation Factor	0.01	Mapped to Input Tab
System lifetime (in Years)	20	Mapped to Input Tab
Emissions Factors - CO (lbs/MWh)	863.25	Used in LCOE worksheet
Emissions Factors - NOx (lbs/MWh)	0.033333333	Used in LCOE worksheet
Emissions Factors - PM10 (lbs/MWh)	0.00002	Used in LCOE worksheet
Depreciation Term	5	Mapped to LCOE tab H25
Partial Equip replacement cost (\$/W)	0	
Partial Equip Replacement Time (years)	0	Mapped to Input Tab. Needs clarification
Program Admin Cost (nonrebate, \$/unit)	\$0.00	Used for PV
Program Admin Cost (nonrebate, \$/kW)	\$94.05	Used for non-PV technologies
PAC price escalator (%/yr)	0.0%	Program Admin Cost Price Escalator
Annual Electric Production	8,409,600	From Technology Production Curves
Annual Electric Charging	0	From Technology Charging Curves for Storage
Annual Gas Production Therms Req'd	623772.9391	From Technology Production Curves
Annual Gas Production Therms Out	154736.64	From Technology Production Curves
On-site Biogas Technology?	FALSE	Controls inputs during calculation
Design Derate Factor	100.00%	Should be 100% for all techs except PV when it is initialized
Installed at a Dairy?	No	Was Technology installed at a Dairy?
Pay Departing Charge?	No	Should Departing Charges be Applied?

Note: all values on this worksheet are obtained from the technology workbook selected for the run.
 Annual Production values are retrieved from the TechnologyProduction worksheet.
 All other values come from the Constants worksheet.
 The workbook names are found in the Inputs sub-directory and have the prefix SGIPce_Inputs_Tech_xx.xlsx

Annual Inputs Tab

The next set of figures show the first seven years of annual inputs found on the AnnualInputs tab. Figure 5-14 and Figure 5-15 show the inputs obtained from the currently selected technology workbook that are used as first-year values in the calculations. Figure 5-16 and Figure 5-17 show the annual values of inputs used in the model over the life of the selected technology.

Figure 5-14: Annual Inputs

Short-term Inputs (14 periods)		Iron_wGrthRate_Global Capacity						
System Prices		Est. Growth Rate	2007	2008	2009	2010	2011	2012
Cumulative global capacity	(MW)	26%	133	184	214	271	341	431
Price	(nominal \$/W)	81.62%	\$ 6.01	\$ 6.01	\$ 6.01	\$ 5.73	\$ 5.45	\$ 5.20
Historical Price	(nominal \$/kW)	81.62%	\$6,009	\$6,009	\$6,009			
The values in orange are obtained from the technology workbook selected for this run on the worksheet named AnnualInputs								
Other Prices		Escalator	2007	2008	2009	2010	2011	2012
Inverter Price	(\$/W)	0%	\$0.00	\$0.00	\$0.00	\$0.00	\$0.00	\$0.00
Historical Other Prices	(\$/W)	0%	\$0.14	\$0.14	\$0.14	\$0.15	\$0.15	\$0.15
Inverter Price	(\$/kW)		\$0.00	\$0.00	\$0.00			
Historical Other Prices	(\$/kW)		\$144.00	\$144.00	\$144.00			
The values in orange are obtained from the technology workbook selected for this run on the worksheet named AnnualInputs. Inverter Price is not currently used.								
O&M		Escalator	2007	2008	2009	2010	2011	2012
Cost	(\$/kWh)	0%	\$0.03	\$0.03	\$0.03	\$0.03	\$0.03	\$0.03
Historical Cost	(\$/kWh)		\$0.03	\$0.03	\$0.03			
The values in orange are obtained from the technology workbook selected for this run on the worksheet named AnnualInputs. Where should the escalator be for O&M???								
REC Inputs		Escalator	2007	2008	2009	2010	2011	2012
Price	(\$/W)		\$0.035	\$0.035	\$0.035	\$0.035	\$0.035	\$0.035
Escalator	(%/Yr)		0.0%	0.0%	0.0%	0.0%	0.0%	0.0%
Multiplier	(L0)		1	1	1	1	1	1
The values in orange are obtained from the technology workbook selected for this run on the worksheet named AnnualInputs								
Rebates		Years	2007	2008	2009	2010	2011	2012
EPBB	(\$/W)		\$3.75	\$3.75	\$4.13	\$4.13	\$4.13	\$4.13
PBI	(\$/kWh)	5	\$0.1349	\$0.1349	\$0.1486	\$0.1486	\$0.1486	\$0.1486
The values in orange are obtained from the technology workbook selected for this run on the worksheet named AnnualInputs								

Figure 5-15: Annual Inputs (continued)

Tax Credit Rate		2007	2008	2009	2010	2011	2012
% of Equip. Cost		30%	30%	30%	30%	30%	30%
The values in orange are obtained from the technology workbook selected for this run on the worksheet named AnnualInputs							
Global Annual Inputs		2007	2008	2009	2010	2011	2012
Inflation Rate	(%)	\$0.02	\$0.02	\$0.02	\$0.02	\$0.02	\$0.02
Insurance Expense Multiplier	(%)	0.5%	0.5%	0.5%	0.5%	0.5%	0.5%
Insurance Escalator	(%/yr)	2.00%	2.00%	2.00%	2.00%	2.00%	2.00%
O&M Escalator	(%)	2.00%	2.00%	2.00%	2.00%	2.00%	2.00%
The values in orange are obtained from the SGIPce_Inputs_Global.xlsm workbook on the Global_Inputs tab.							

Figure 5-16: Annual Inputs (continued)

Long-term Inputs (33 periods)		2007	2008	2009	2010	2011	2012
Electric Rates		2007	2008	2009	2010	2011	2012
Bill Savings pre GHG multiplier (\$/kWh)	(\$/kWh)	\$ 0.1372	\$ 0.1258	\$ 0.1271	\$ 0.1246	\$ 0.1284	\$ 0.1322
Bill Savings (\$/kWh)	(\$/kWh)	\$ 0.1372	\$ 0.1258	\$ 0.1271	\$ 0.1246	\$ 0.1284	\$ 0.1322
Bill Costs pre GHG Mult. from Charging (\$/kWh)	(\$/kWh)	\$ -	\$ -	\$ -	\$ -	\$ -	\$ -
Bill Cost from Charging (\$/kWh)	(\$/kWh)	\$ -	\$ -	\$ -	\$ -	\$ -	\$ -
The values in orange are obtained from the SGIPce_Inputs_Rates.xlsm workbook on the FC_CalcAveUtilRate_E tab.							
Gas Rates		2007	2008	2009	2010	2011	2012
Transportation Savings	(\$)	\$0	\$0	\$0	\$0	\$0	\$0
Increase in Bills, CHP Gen	(\$)	\$555,738	\$555,738	\$281,914	\$355,263	\$396,317	\$422,930
Decrease in Bills, CHP Blr. Sav.	(\$)	\$194,803	\$194,803	\$110,779	\$134,407	\$147,622	\$156,369
Annual Gas Production Thermo Req'd	(\$/therm)	\$1.280	\$1.291	\$0.864	\$0.994	\$1.072	\$1.128
Annual Gas Production Thermo Out	(\$/therm)	\$1.007	\$1.007	\$0.673	\$0.695	\$0.763	\$0.808
The values in orange are obtained from the SGIPce_Inputs_Gas_Transportation.xlsx workbook on the UseinCECalcEng tab.							
Gas Price Adder for Directed Bio-gas		2007	2008	2009	2010	2011	2012
Adder	(\$/kWh)	2.970%	\$0.39	\$0.40	\$0.41	\$0.42	\$0.44
Historical Adder	(\$/kWh)	\$0.39	\$0.40	\$0.41			
The values in orange are obtained from the technology workbook selected for this run on the worksheet named AnnualInputs							
Emissions Cost		2007	2008	2009	2010	2011	2012
Emissions Factors - CO (\$/ton)	(\$/ton)	\$10.53	\$10.5317	\$11.5755	\$12.7226	\$13.9835	\$15.3693
Emissions Factors - NOx (\$/lb)	(\$/LB)	\$4.63	\$4.6286	\$4.6286	\$4.6286	\$5.2900	\$5.8190
Emissions Factors - PM10 (\$/lb)	(\$/LB)	\$6.47	\$6.4750	\$6.4750	\$6.4750	\$7.4002	\$8.1403
The values in orange are obtained from the SGIPce_Inputs_Global.xlsm workbook on the Global_Inputs tab.							

Figure 5-17: Annual Inputs (continued)

Average Avoided Cost Rate		2007	2008	2009	2010	2011	2012
AVC Electric (\$/kWh)	(\$/kWh)	\$0.0906	\$0.0906	\$0.0524	\$0.0753	\$0.0860	\$0.0908
AVC Electric (\$/MWh)	(\$/MWh)	\$90.56	\$90.5591	\$52.3779	\$75.3083	\$86.0392	\$90.8263
AVC Electric Charging (\$/kWh)	(\$/kWh)	\$0.0000	\$0.0000	\$0.0000	\$0.0000	\$0.0000	\$0.0000
AVC Electric Charging (\$/MWh)	(\$/MWh)	\$0.00	\$0.0000	\$0.0000	\$0.0000	\$0.0000	\$0.0000
AVC Gas Required (\$/therm)	(\$/therm)	\$0.91	\$0.9059	\$0.4445	\$0.5481	\$0.6164	\$0.6590
AVC Gas Out (\$/therm)	(\$/therm)	\$0.99	\$0.9902	\$0.5349	\$0.6452	\$0.7241	\$0.7774
AVC Gas Required - PA test only (\$/therm)	(\$/therm)	\$0.00	\$0.0000	\$0.0000	\$0.0000	\$0.0000	\$0.0000
AVC Gas Out - PA test only (\$/therm)	(\$/therm)	\$0.00	\$0.0000	\$0.0000	\$0.0000	\$0.0000	\$0.0000
AVC Electric is obtained from the SGIPce_Inputs_AvoidedCosts.xlsm workbook on the tab appropriate based on the selected utility and climate region. AVC Gas Required and Gas Out are obtained from the SVIPce_Inputs_AvoidedCostsGas.xlsm on the tab appropriate based on the selected utility and sector.							
GHG Price Multiplier		2007	2008	2009	2010	2011	2012
Electric Price Multiplier	(L.0)	1	1	1	1	1	1
Gas Price Multiplier	(L.0)	1	1	1	1	1	1

Finance Tab

The following two figures show the last of the inputs used to calculate results in the model. Figure 5-18 shows a table of variables that hold values that are constant throughout the simulation of the selected technology. The *Utility Discount Rate* and the *Societal Discount Rate* are used in the calculation of levelized values in the LCOE worksheet. The *PPA Escalator* is set to zero at this time and the *Rebate Type* is set based on the type of rebate specified by the user.

Figure 5-18: Finance Tab (Global Values)

Global Variables														
Utility Discount Rate	8.65%	This value is initialize from SGIPce_Inputs_Global.xlsm on the Global_Constants tab												
Societal Discount Rate	5.06%	This value is initialize from SGIPce_Inputs_Global.xlsm on the Global_Constants tab												
PPA Escalator	0.00%													
Rebate Type	3	None = 1, PBI = 2, EPBB = 3												

Figure 5-19 shows annual financial inputs used over the forecast period. In the upper left corner the type of financing selected by the user is displayed. This cell is set by the system based on the user’s selection in the Technology list in the Run Processor. It supplies information to the system about what logic to use with respect to financing. The other values in this table are supplied directly to the table found on the Input tab for use by the LCOE calculation.

Figure 5-19: Finance Tab (Annual Values)

Financing Inputs														
Debt/Equity	2007	2008	2009	2010	2011	2012	2013	2014	2015	2016	2017	2018	2019	2020
Federal Tax Rate	35%	35%	35%	35%	35%	35%	35%	35%	35%	35%	35%	35%	35%	35%
State Tax Rate	8.84%	8.84%	8.84%	8.84%	8.84%	8.84%	8.84%	8.84%	8.84%	8.84%	8.84%	8.84%	8.84%	8.84%
Apply Tax Credit	1	1	1	1	1	1	1	1	1	1	1	1	1	1
Percent financed with Equity	60%	60%	60%	60%	60%	60%	60%	60%	60%	60%	60%	60%	60%	60%
Debt Interest Rate	0.08	0.08	0.08	0.08	0.08	0.08	0.08	0.08	0.08	0.08	0.08	0.08	0.08	0.08
Target DSCR	1.40	1.40	1.40	1.40	1.40	1.40	1.40	1.40	1.40	1.40	1.40	1.40	1.40	1.40
Years of Debt Service in DSRF	1	1	1	1	1	1	1	1	1	1	1	1	1	1
WACC	8.25%	8.25%	8.25%	8.25%	8.25%	8.25%	8.25%	8.25%	8.25%	8.25%	8.25%	8.25%	8.25%	8.25%
Cost of Equity	10.72%	10.72%	10.72%	10.72%	10.72%	10.72%	10.72%	10.72%	10.72%	10.72%	10.72%	10.72%	10.72%	10.72%

Note: all values in yellow are initialized from SGIPce_Inputs_Global.xlsm workbook.
 They come from the tab named Global_Financing.
 Greyed values are not used

6

Technology Workbooks

6.1 Overview

The Technology workbooks are a set of workbooks that hold the inputs for the technologies. These workbooks were developed by the Itron and E3 engineers and represent the most current information available about these technologies. This section will go through these workbooks and describe the worksheets contained in them. It will describe the four tabs that contain the data used by the system to do the calculations.

Tabs following the first four system tabs contain the working calculations used by the engineers to calculate the values used by the model. These worksheets were setup to be free form and self-documenting. No attempt will be made to explain these sheets in this document.

6.2 Technology Workbooks Described

6.2.1 List of Workbooks

Table 6-1 shows a complete list of technology workbooks used by the model. The table contains the file name of the workbook and a description of the unit capacity, sector, fuel type and coastal region (if appropriate).¹ If the technology has the ability to be used as a CHP technology, the technology is modeled as CHP unless otherwise noted. These files can be found in the Inputs folder located inside the folder where the system has been installed.

These workbooks have been made read-only to help prevent inadvertent alteration of their contents. It is advised that a copy be made of the file and stored in a different location as a backup before changing the read-only flag and altering the workbook.

The rest of this section of the User Guide will describe the various tabs found in the workbook and how they are used in the system.

¹ In general, the technologies are divided into the residential and non-residential sectors, where the non-residential sectors describe both the government/non-profit and commercial sectors. For PV, however, the non-residential sector is explicitly divided into government/non-profit and commercial due to different rebate structures.

Table 6-1: List of Technology Workbooks

Workbook Name	Description
Fuel Cells	
<i>SGIPce_Inputs_Tech_FC5kW_RES_NG.xlsx</i>	5 kW, Res, Natural Gas, Non-CHP
<i>SGIPce_Inputs_Tech_FC1200kW_NR_DIRBGas.xlsx</i>	1.2 MW, Non-Res, Directed Bio-Gas
<i>SGIPce_Inputs_Tech_FC1200kW_NR_NG.xlsx</i>	1.2 MW, Non-Res, Natural Gas
<i>SGIPce_Inputs_Tech_FC1200kW_NR_OSBGas.xlsx</i>	1.2 MW, Non-Res, On-site Bio-Gas
<i>SGIPce_Inputs_Tech_FC1200kWe_NR_DIRBGas.xlsx</i>	1.2 MW, Non-Res, Directed Bio-Gas, Non-CHP
<i>SGIPce_Inputs_Tech_FC1200kWe_NR_NG.xlsx</i>	1.2 MW, Non-Res, Natural Gas, Non-CHP
<i>SGIPce_Inputs_Tech_FC1200kWe_NR_OSBGas.xlsx</i>	1.2 MW, Non-Res, On-site Bio-Gas, Non-CHP
Gas Turbines	
<i>SGIPce_Inputs_Tech_GTg2to5MW_NR_DIRBGas.xlsx</i>	2 to 5 MW, Non-Res, Directed Bio-Gas
<i>SGIPce_Inputs_Tech_GTg2to5MW_NR_NG.xlsx</i>	2 to 5 MW, Non-Res, Natural Gas
<i>SGIPce_Inputs_Tech_GTg2to5MW_NR_OSBGas.xlsx</i>	2 to 5 MW, Non-Res, On-site Bio-Gas
<i>SGIPce_Inputs_Tech_GTle2MW_NR_DIRBGas.xlsx</i>	< 2 MW, Non-Res, Directed Bio-Gas
<i>SGIPce_Inputs_Tech_GTle2MW_NR_NG.xlsx</i>	< 2 MW, Non-Res, Natural Gas
<i>SGIPce_Inputs_Tech_GTle2MW_NR_OSBGas.xlsx</i>	< 2 MW, Non-Res, On-site Bio-Gas
Internal Combustion Engine	
<i>SGIPce_Inputs_Tech_ICE500kW_NR_DIRBGas.xlsx</i>	500 kW, Non-Res, Directed Bio-Gas
<i>SGIPce_Inputs_Tech_ICE500kW_NR_NG.xlsx</i>	500 kW, Non-Res, Natural Gas
<i>SGIPce_Inputs_Tech_ICE500kW_NR_OSBGas.xlsx</i>	500 kW, Non-Res, On-site Bio-Gas
<i>SGIPce_Inputs_Tech_ICE1500kW_NR_DIRBGas.xlsx</i>	1.500 MW, Non-Res, Directed Bio-Gas
<i>SGIPce_Inputs_Tech_ICE1500kW_NR_NG.xlsx</i>	1.500 MW, Non-Res, Natural Gas
<i>SGIPce_Inputs_Tech_ICE1500kW_NR_OSBGas.xlsx</i>	1.500 MW, Non-Res, On-site Bio-Gas
Micro Turbines	
<i>SGIPce_Inputs_Tech_MT200kW_NR_DIRBGas.xlsx</i>	200 kW, Non-Res, Directed Bio-Gas
<i>SGIPce_Inputs_Tech_MT200kW_NR_NG.xlsx</i>	200 kW, Non-Res, Natural Gas
<i>SGIPce_Inputs_Tech_MT200kW_NR_OSBGas.xlsx</i>	200 kW, Non-Res, On-site Bio-Gas
Organic Rankine Cycle Waste Heat Turbine	
<i>SGIPce_Inputs_Tech_ORC500kW_NR_NA.xlsx</i>	500 kW, Non-Res, No fuel specified
Photo Voltaic Systems	
<i>SGIPce_Inputs_Tech_PVCoast_GNP_NA.xlsx</i>	≈50 kW, Coast, Government, No Fuel
<i>SGIPce_Inputs_Tech_PVCoast_NR_NA.xlsx</i>	≈50 kW, Coast, Non-Res, No Fuel
<i>SGIPce_Inputs_Tech_PVCoast_RES_NA.xlsx</i>	≈4.5 kW, Coast, Residential, No Fuel
<i>SGIPce_Inputs_Tech_PVInland_GNP_NA.xlsx</i>	≈70 kW, Inland, Government, No Fuel
<i>SGIPce_Inputs_Tech_PVInland_NR_NA.xlsx</i>	≈70 kW, Inland, Non-Res, No Fuel
<i>SGIPce_Inputs_Tech_PVInland_RES_NA.xlsx</i>	≈6 kW, Inland, Residential, No Fuel

Table 6-1: List of Technology Workbooks (continued)

Workbook Name	Description
Storage Systems	
<i>SGIPce_Inputs_Tech_Storage1MW_NR_NA.xlsx</i>	1 MW, Non-Res, No Fuel Specified
<i>SGIPce_Inputs_Tech_Storage25kW_NR_NA.xlsx</i>	25 kW, Non-Res, No Fuel Specified
<i>SGIPce_Inputs_Tech_Storage25kW_Res_NA.xlsx</i>	25 kW, Residential, No Fuel Specified
Wind Systems	
<i>SGIPce_Inputs_Tech_WD1MW_NR_NA.xlsx</i>	1 MW, Non-Res, No Fuel
<i>SGIPce_Inputs_Tech_WD10kW_RES_NA.xlsx</i>	10 kW, Residential, No Fuel

6.2.2 Tabs in the Technology Workbooks

Constants Tab

The following table shows a snapshot of the Constants tab in the Technology workbook. This tab supplies constant data to the Calc Engine that can generally be found on the Technology tab in that workbook. The engineers developing these data used other tabs in the workbook to calculate the values found here and then placed cell references in these cells to populate and document the values found on the Constants tab. As a convention, the engineers were asked to supply information to the cells with a yellow background. This convention continues throughout the Technology workbook examples.

Figure 6-1: Constants Tab

Constants		Input	Notes
Technology Level Constants			
System Size (kW)		1200	Engineering estimate of average installation size of commercially available MCFC, SOFC, and PAFC.
DC to AC Derate Factor		1	Derate factor to account for lower btu in biogas
Average Annual Capacity Factor		0.8	Comes from TechnologyProduction tab.
Degradation Factor		1.00%	Rate at which equipment production degrades over time, estimated from literature and specification sheets.
System lifetime (in Years)		20	System lifetime - entire balance of plant, NOT stack life.
Therm to kW produced (see Gas Transportation)		1,840	This is zero for electric only fuel cells, other figures for CHP
Emissions Factors - CO2 (lbs/MWh)		863	
Emissions Factors - NOx (lbs/MWh)		0.03	
Emissions Factors - PM10 (lbs/MWh)		0.00002	Unweighted averages of FCE, UTC, and BloomEnergy spec sheets.
Depreciation Term		5	Use 5 unless otherwise specified.
Partial Equip replacement cost (\$/W)			Stack replacement included in O&M Costs 5-10 years from phone interviews and specification sheets, but included in O&M costs
Partial Equip replacement time (in Years)			
Program Admin Cost (nonrebate, \$/unit)		\$0.00	Used for PV only
Program Admin Cost (nonrebate, \$/kW)		\$94.05	From SGIP Program
PAC price escalator (%/yr)		0%	Program Admin Cost inflator
Electrical Efficiency %		46%	Based on averages from UTC, FCE, and BloomEnergy specifications sheets.
Non-CHP gas use (therms/year)		100000	Estimated by team
Is this an On-site Biogas technology?			If this workbook represents an On-site Bio Gas technology then set to Yes, No otherwise set to No
Design Derate Factor		100%	100% for all technologies except PV
Utility	PGE		Initialized by SGIPce (PGE, SCE, SDGE)
Pay Departing Charge?		Yes	Should departing charges be applied to the current technology?
Expected Capacity Factor		0.8	Set expected Capacity Factor (Actual = default production curves. Use a decimal value between 0 and 1 for expected value)

All items in this table are not copied to the Calc Engine. Some are used elsewhere in the Technology workbooks. Items not copied to Calc Engine are Therm to kW produced, Electrical Efficiency %, Non-CHP gas use.

Annual Inputs Tab

Figure 6-2 and Figure 6-3 show the contents of the second worksheet in the Technology workbook that is used directly by the system. These figures show the first six years of data for each concept being supplied. The yellow cells are the cells that are supplied by the engineers and are pulled into the Calc Engine. The blue cells are formulas that allow the engineer to view their results. The calculations are replicated in the Calc Engine exactly.

Figure 6-2: Annual Inputs

Inputs by Year							
System Prices (\$/KWac)							
Cumulative global capacity (MW)		2007	2008	2009	2010	2011	2012
Estimated growth rate of:		26%	133	184	214	271	341
System prices (\$/KWac)		2007	2008	2009	2010	2011	2012
Progress ratios estimates:		82%	\$ 6,009.00	\$ 6,009.00	\$6,009.00	\$5,613	\$5,243
Other Prices not in System (\$/KWac)							
Other prices (\$/KWac)		2007	2008	2009	2010	2011	2012
Waste Heat Recovery Escalator:		0%	144	144	144	144	144
O&M (\$/KWbac) (levelized)							
Other prices (\$/KWbac)		2007	2008	2009	2010	2011	2012
Balance of Plant O&M Escalator:		0%	\$0.03	\$0.03	\$ 0.03	\$0.03	\$0.03
Gas Price Adder for Directed Bio-gas							
Gas Price Adder (\$/therm)		2007	2008	2009	2010	2011	2012
Escalator:		0.00%	\$0.0000	\$0.0000	\$0.0000	\$0.0000	\$0.0000

Figure 6-3: Annual Inputs (continued)

REC Inputs							
REC price (\$/W)		2007	2008	2009	2010	2011	2012
REC price escalator (%/yr)		0%	0%	0%	0%	0%	0%
EPBB Rebates (\$/W)							
(\$/W)		2007	2008	2009	2010	2011	2012
Escalator:		0.00%	\$2.08	\$2.08	\$2.29	\$2.29	\$2.29
PBI Rebates (\$/kWh)							
(\$/kWh)		Years	2007	2008	2009	2010	2011
Escalator:		5	\$0.0748	\$0.0748	\$0.0824	\$0.0824	\$0.0824
Tax Credit Rate							
% of Equip Cost		2017	2007	2008	2009	2010	2011
Escalator:		2017	30%	30%	30%	30%	30%

Technology Production & Production Curves Tabs

In Figure 6-4 shows the tab representing the technology production curves. This worksheet draws data from other worksheets to calculate the electric 8,760 shapes for electric production, electric consumption (for storage), total therms required, and useful therms out. Note the cells in the upper left corner of Figure 6-4. The system updates these cells with the current utility code and climate region code before copying the data from this table. The formulas behind these data are designed to reference a secondary worksheet that holds all the production values for all combinations of these fields. Figure 6-5 shows a snippet of this secondary worksheet called ProductionCurves. The data from this table combined with the data from the distribution table in Figure 6-6 are used to develop the composite 8,760 shapes shown in Figure 6-4.

The 8,760 shapes were drawn from actual metered technology production currently in use in California.

Figure 6-4: Technology Production

PGE		Coast						
Date	Hour	kWh per kW rebated	kWh	Total Therm In Reqd	Useful Therm Out	Usage Month	Total Therm In Reqd	Useful Therm Out
1/1/2009	0	0.776097735	931.3172817	69.1	17.1	Jan	52,383	12,995
1/1/2009	1	0.776342123	931.6105476	69.1	17.1	Feb	47,593	11,806
1/1/2009	2	0.774263172	929.1158062	68.9	17.1	Mar	53,284	13,218
1/1/2009	3	0.772550803	927.0609636	68.8	17.1	Apr	52,341	12,984
1/1/2009	4	0.776219929	931.4639146	69.1	17.1	May	51,894	12,873
1/1/2009	5	0.778788482	934.5461785	69.3	17.2	Jun	53,821	13,351
1/1/2009	6	0.780256463	936.3077553	69.4	17.2	Jul	54,389	13,492
1/1/2009	7	0.779033696	934.8404352	69.3	17.2	Aug	53,299	13,222
1/1/2009	8	0.778544094	934.2529127	69.3	17.2	Sep	51,050	12,664
1/1/2009	9	0.777198307	932.6379689	69.2	17.2	Oct	52,903	13,123
1/1/2009	10	0.774263172	929.1158062	68.9	17.1	Nov	48,311	11,984
1/1/2009	11	0.772550803	927.0609636	68.8	17.1	Dec	52,504	13,024
1/1/2009	12	0.770226638	924.2719655	68.6	17.0			
1/1/2009	13	0.768024667	921.6296004	68.4	17.0			
1/1/2009	14	0.765578308	918.6939695	68.1	16.9			
1/1/2009	15	0.767168483	920.6021791	68.3	16.9			
1/1/2009	16	0.767290677	920.7488121	68.3	16.9			
1/1/2009	17	0.768514269	922.2171229	68.4	17.0			
1/1/2009	18	0.770104444	924.1253326	68.5	17.0			
1/1/2009	19	0.773406987	928.0883849	68.8	17.1			
1/1/2009	20	0.776953919	932.344703	69.2	17.2			
1/1/2009	21	0.779889888	935.8678565	69.4	17.2			
1/1/2009	22	0.780378657	936.4543882	69.5	17.2			
1/1/2009	23	0.781357035	937.6284424	69.5	17.3			
1/2/2009	0	0.742643794	891.172553	66.1	16.4			
1/2/2009	1	0.743220088	891.8641057	66.2	16.4			
1/2/2009	2	0.743961509	892.7538109	66.2	16.4			
1/2/2009	3	0.745252804	894.3033643	66.3	16.5			
1/2/2009	4	0.74539151	894.4698125	66.3	16.5			
1/2/2009	5	0.745248675	894.2984105	66.3	16.5			
1/2/2009	6	0.744061411	892.8736932	66.2	16.4			
1/2/2009	7	0.739804432	887.7653189	65.8	16.3			
1/2/2009	8	0.738029315	885.6351783	65.7	16.3			
1/2/2009	9	0.731999903	878.3998833	65.2	16.2			
1/2/2009	10	0.721998769	866.3985226	64.3	15.9			

Figure 6-5: Production Curves

Date	Hour	PGE_Coast	PGE_Inland	SCE_Coast	SCE_Inland	SDGE_Coast	SDGE_Inland	Base_Flat_Ave	Base_Step_Ave	Non-Base_Peak_Coast_Ave	Non-Base_Peak_Inland
1/1/2009	0	0.752	0.752	0.752	0.752	0.752	0.752	0.940	0.000	0.118	0.114
1/1/2009	1	0.752	0.752	0.752	0.752	0.752	0.752	0.940	0.000	0.121	0.109
1/1/2009	2	0.750	0.750	0.750	0.750	0.750	0.750	0.938	0.000	0.124	0.111
1/1/2009	3	0.749	0.749	0.749	0.749	0.749	0.749	0.936	0.000	0.133	0.117
1/1/2009	4	0.752	0.752	0.752	0.752	0.752	0.752	0.940	0.000	0.148	0.130
1/1/2009	5	0.755	0.755	0.755	0.755	0.755	0.755	0.943	0.000	0.156	0.133
1/1/2009	6	0.756	0.756	0.756	0.756	0.756	0.756	0.945	0.000	0.180	0.160
1/1/2009	7	0.755	0.755	0.755	0.755	0.755	0.755	0.944	0.000	0.188	0.183
1/1/2009	8	0.754	0.754	0.754	0.754	0.754	0.754	0.943	0.000	0.170	0.178
1/1/2009	9	0.753	0.753	0.753	0.753	0.753	0.753	0.941	0.000	0.151	0.182
1/1/2009	10	0.750	0.750	0.750	0.750	0.750	0.750	0.938	0.000	0.154	0.235
1/1/2009	11	0.749	0.749	0.749	0.749	0.749	0.749	0.936	0.000	0.187	0.272
1/1/2009	12	0.746	0.746	0.746	0.746	0.746	0.746	0.933	0.000	0.240	0.323
1/1/2009	13	0.744	0.744	0.744	0.744	0.744	0.744	0.930	0.000	0.213	0.357
1/1/2009	14	0.742	0.742	0.742	0.742	0.742	0.742	0.927	0.000	0.249	0.393
1/1/2009	15	0.743	0.743	0.743	0.743	0.743	0.743	0.929	0.000	0.262	0.393
1/1/2009	16	0.743	0.743	0.743	0.743	0.743	0.743	0.929	0.000	0.195	0.344
1/1/2009	17	0.745	0.745	0.745	0.745	0.745	0.745	0.931	0.000	0.183	0.264
1/1/2009	18	0.746	0.746	0.746	0.746	0.746	0.746	0.933	0.000	0.142	0.204
1/1/2009	19	0.749	0.749	0.749	0.749	0.749	0.749	0.937	0.000	0.148	0.177
1/1/2009	20	0.753	0.753	0.753	0.753	0.753	0.753	0.941	0.000	0.117	0.140
1/1/2009	21	0.756	0.756	0.756	0.756	0.756	0.756	0.945	0.000	0.111	0.127
1/1/2009	22	0.756	0.756	0.756	0.756	0.756	0.756	0.945	0.000	0.114	0.123
1/1/2009	23	0.757	0.757	0.757	0.757	0.757	0.757	0.946	0.000	0.129	0.121
1/2/2009	0	0.720	0.720	0.720	0.720	0.720	0.720	0.899	0.000	0.133	0.117
1/2/2009	1	0.720	0.720	0.720	0.720	0.720	0.720	0.900	0.000	0.137	0.121
1/2/2009	2	0.721	0.721	0.721	0.721	0.721	0.721	0.901	0.000	0.139	0.118
1/2/2009	3	0.722	0.722	0.722	0.722	0.722	0.722	0.903	0.000	0.142	0.121
1/2/2009	4	0.722	0.722	0.722	0.722	0.722	0.722	0.903	0.000	0.166	0.147
1/2/2009	5	0.722	0.722	0.722	0.722	0.722	0.722	0.903	0.000	0.184	0.168
1/2/2009	6	0.721	0.721	0.721	0.721	0.721	0.721	0.901	0.000	0.208	0.188
1/2/2009	7	0.717	0.717	0.717	0.717	0.717	0.717	0.896	0.000	0.215	0.206
1/2/2009	8	0.715	0.715	0.715	0.715	0.715	0.715	0.894	0.000	0.215	0.195
1/2/2009	9	0.709	0.709	0.709	0.709	0.709	0.709	0.887	0.000	0.212	0.189
1/2/2009	10	0.700	0.700	0.700	0.700	0.700	0.700	0.874	0.000	0.204	0.170
1/2/2009	11	0.699	0.699	0.699	0.699	0.699	0.699	0.873	0.000	0.201	0.176

Figure 6-6: Distribution Table

	PGE Coast	PGE Inland	SCE Coast	SCE Inland	SDGE Coast	SDGE Inland
Base_Flat_Ave	80%	80%	80%	80%	80%	80%
Base_Step_Ave	20%	20%	20%	20%	20%	20%
Non-Base_Peak_Coast_Ave	0%	0%	0%	0%	0%	0%
Non-Base_Peak_Inland_Ave	0%	0%	0%	0%	0%	0%
Non-Base_MultiPeak_Coast_Ave	0%	0%	0%	0%	0%	0%
Non-Base_MultiPeak_Inland_Ave	0%	0%	0%	0%	0%	0%
Total	100%	100%	100%	100%	100%	100%

Other Tabs

Each Technology workbook has a set of other tabs that contain the working data used by the engineers to supply the inputs to the model. The engineers were given instructions that they should use as many tabs as they needed to develop the data and document the resources for their work. No restrictions were imposed on these tabs. The only instruction was that the input data found on the first three or four tabs must reference these worksheets so as to document the data in the input worksheets. The user can and should look through these tabs and familiarize themselves with what the engineers did to develop the technology inputs used in the model.

7

Other Input Workbooks

7.1 Overview

This section of the user guide describes the other workbooks used by the model. These workbooks supply data to the system as needed by each run. As with all the other workbooks, there are no links to these workbooks in the system. All data are copied and pasted into the Calc Engine to assure that the workbooks are freestanding.

7.2 List of Other Input Workbooks

Table 7-1 is a list of the other workbooks that supply inputs to the system during operation. The data from these workbooks are copied into the Calc Engine as needed to perform the calculations for the currently selected technology. A brief description is associated with each workbook in the table. Further discussion of the workbooks follows in the remaining sections.

Table 7-1: List of Adoption, Rates, and Avoided Cost Workbooks

Workbook Name	Description
Adoptions	
<i>SGIPce_Inputs_Adoptions.xlsx</i>	Adoptions used by the Results workbook to calculate the Benefit/Cost tests.
Avoided Cost	
<i>SGIPce_Inputs_AvoidedCosts.xlsx</i>	Electric avoided costs for the Base Case scenario.
<i>SGIPce_Inputs_AvoidedCosts_High.xlsx</i>	Electric avoided costs for the Greenhouse Gas scenario.
<i>SGIPce_Inputs_AvoidedCostsGas.xlsx</i>	Gas avoided costs for the Base Case scenario.
<i>SGIPce_Inputs_AvoidedCostsGas_High.xlsx</i>	Gas avoided costs for the Greenhouse Gas scenario.
Global	
<i>SGIPce_Inputs_Global.xlsx</i>	Global & Financial inputs.

Table 7-1: List of Adoption, Rates, and Avoided Cost Workbooks (continued)

Workbook Name	Description
Rates	
<i>SGIPce_Inputs_Rates_NonRes_PGE_A10TOU.xlsx</i>	A10 TOU Non-residential electric rates for PG&E
<i>SGIPce_Inputs_Rates_NonRes_PGE_E19.xlsx</i>	E 19 Non-residential electric rates for PG&E
<i>SGIPce_Inputs_Rates_NonRes_SCE_GS2TOU.xlsx</i>	GS2 TOU Non-residential electric rate for SCE
<i>SGIPce_Inputs_Rates_NonRes_SCE_TOU8.xlsx</i>	TOU 8 Non-residential electric rate for SCE
<i>SGIPce_Inputs_Rates_NonRes_SDGE_A6TOU.xlsx</i>	A6 TOU Non-residential electric rate for SDG&E
<i>SGIPce_Inputs_Rates_NonRes_SDGE_ALTOU.xlsx</i>	AL TOU Non-residential electric rate for SDG&E
<i>SGIPce_Inputs_Rates_Res.xlsx</i>	All Residential rates used in the model.
<i>SGIPce_Inputs_Gas_Transportation.xlsx</i>	Gas transportation rates used in the model.

7.3 Other Input Workbook Descriptions

This section presents each workbook and gives a brief description of the data they contain.

7.3.1 Adoptions Workbook

The Adoptions workbook is split into three distinct types of worksheets. This workbook is opened when the Results workbook(s) are being setup by the system. The calculations of adoptions found on the tab named Adoptions in this workbook are copied and pasted into the Results workbook in the tab of the same name. Only the values of adoptions are copied. No link is maintained between the two workbooks.

List of Available Technologies

The first worksheet, seen in Figure 7-1, shows a listing of all the available technologies. Adoption values are available for all the technologies shown in this list as they are combined with other user- and non-user-specified parameters. The list is used by the workbook as a lookup table to supply information to the formulas in the worksheets.

Figure 7-1: Technology List

Tech Name (Long)	Tab Name	Sector	Type	Type of Tab	MW/Unit
Fuel Cells (1.2 MW)	FC1200kW	NR	CHP	NonRes/CHP	1.2
Fuel Cells Elec Only (1.2 MW)	FC1200kWe	NR		NonRes	1.2
Gas Turbine (<= 2 MW)	GTle2MW	NR	CHP	NonRes/CHP	1
Gas Turbine (>2-5 MW)	GTg2to5MW	NR	CHP	NonRes/CHP	3.5
ICE (1.5 MW)	ICE1500kW	NR	CHP	NonRes/CHP	1.5
ICE (500 kW)	ICE500kW	NR	CHP	NonRes/CHP	0.5
Micro Turbine (200 kW)	MT200kW	NR	CHP	NonRes/CHP	0.2
ORC (500 kW)	ORC500kW	NR		NonRes	0.5
PVCoast	NRPV	NR	Renew	NonRes/Renew	0.045
PVInland	NRPV	NR	Renew	NonRes/Renew	0.062
Wind (1 MW)	WD1MW	NR	Renew	NonRes/Renew	1
PVCoast	RPV	Res	Renew	Res/Renew	0.004
PVInland	RPV	Res	Renew	Res/Renew	0.005
Wind (10 kW)	WD10kW	Res	Renew	Res/Renew	0.01
Fuel Cells (5 kW)	FC5kW	Res		Res	0.005
Res Storage (25kW)	RStorage25kW	Res		Res	0.025
NR Storage (25kW)	NRStorage25kW	NR		NonRes	0.025
Storage (1 MW)	Storage1MW	NR		NonRes	1

Adoptions Table

The second section of the workbook contains all the available adoption values for all possible combinations of technologies by sector, utility, fuel, and climate region. An example of this worksheet is presented in Figure 7-2, where a snippet of the technology combinations available to the system is shown. The 14 years of adoptions are made available to the system for each technology combination. The adoption values are calculated in the third section of this workbook. The data on this worksheet are the data that are copied into the Results workbook on the Adoptions tab when the workbook is created by the system.

Figure 7-2: Adoptions Table

Adoptions (MW)	per Un	2007	2008	2009	2010	2011	2012	2013	2014	2015	2016	2017	2018	2019	2020
PVCoast_Res_NA_PGE_C	0.004	3.7	5.1	6.1	7.2	8.4	9.6	2.8	-	-	-	-	-	-	-
PVCoast_Res_NA_SCE_C	0.004	3.4	6.1	8.2	11.5	12.9	15.3	17.7	20.0	22.4	7.1	-	-	-	-
PVCoast_Res_NA_SDGE_C	0.004	0.9	1.7	4.1	5.4	7.0	3.1	0.0	0.0	0.0	0.0	0.0	0.0	0.0	0.0
PVInland_Res_NA_PGE_I	0.005	18.3	25.0	29.6	35.3	40.9	46.6	13.7	-	-	-	-	-	-	-
PVInland_Res_NA_SCE_I	0.005	3.9	6.8	9.2	13.0	14.6	17.3	20.0	22.7	25.4	8.1	-	-	-	-
PVInland_Res_NA_SDGE_I	0.005	1.6	2.8	6.9	9.1	11.7	5.2	0.0	0.0	0.0	0.0	0.0	0.0	0.0	0.0
WD10kW_Res_NA_PGE_C	0.010	-	-	-	0.1	0.1	0.1	0.1	0.1	0.1	0.1	0.1	0.1	0.1	0.1
WD10kW_Res_NA_PGE_I	0.010	-	-	-	0.1	0.1	0.1	0.1	0.1	0.1	0.1	0.1	0.1	0.1	0.1
WD10kW_Res_NA_SCE_C	0.010	-	-	-	0.0	0.0	0.0	0.0	0.0	0.0	0.1	0.1	0.1	0.1	0.1
WD10kW_Res_NA_SCE_I	0.010	-	-	-	0.1	0.1	0.1	0.1	0.1	0.1	0.1	0.1	0.2	0.2	0.2
WD10kW_Res_NA_SDGE_C	0.010	-	-	-	0.0	0.0	0.0	0.0	0.0	0.0	0.0	0.0	0.0	0.0	0.1
WD10kW_Res_NA_SDGE_I	0.010	-	-	-	0.1	0.1	0.1	0.1	0.1	0.1	0.1	0.2	0.2	0.2	0.2
FC5kW_Res_NG_PGE_C	0.005	-	0.1	0.1	0.1	0.1	0.1	0.1	0.1	0.1	0.1	0.2	0.2	0.2	0.2
FC5kW_Res_NG_PGE_I	0.005	-	0.1	0.1	0.1	0.1	0.1	0.1	0.1	0.1	0.1	0.2	0.2	0.2	0.2
FC5kW_Res_NG_SCE_C	0.005	-	0.1	0.1	0.1	0.1	0.1	0.1	0.1	0.1	0.1	0.1	0.1	0.1	0.1
FC5kW_Res_NG_SCE_I	0.005	-	0.1	0.1	0.1	0.1	0.1	0.1	0.1	0.1	0.1	0.1	0.1	0.1	0.1
FC5kW_Res_NG_SDGE_C	0.005	-	0.1	0.1	0.1	0.1	0.1	0.1	0.1	0.1	0.2	0.2	0.3	0.3	0.4
FC5kW_Res_NG_SDGE_I	0.005	-	0.1	0.1	0.1	0.1	0.1	0.1	0.1	0.1	0.2	0.2	0.3	0.3	0.4
Storage25kW_Res_NA_PGE_C	0.025	-	0.1	0.1	0.1	0.1	0.1	0.1	0.1	0.1	0.1	0.2	0.2	0.2	0.2
Storage25kW_Res_NA_PGE_I	0.025	-	0.1	0.1	0.1	0.1	0.1	0.1	0.1	0.1	0.1	0.2	0.2	0.2	0.2
Storage25kW_Res_NA_SCE_C	0.025	-	0.1	0.1	0.1	0.1	0.1	0.1	0.1	0.1	0.1	0.1	0.1	0.1	0.1
Storage25kW_Res_NA_SCE_I	0.025	-	0.1	0.1	0.1	0.1	0.1	0.1	0.1	0.1	0.1	0.1	0.1	0.1	0.1
Storage25kW_Res_NA_SDGE_C	0.025	-	0.1	0.1	0.1	0.1	0.1	0.1	0.1	0.1	0.2	0.2	0.3	0.3	0.4
Storage25kW_Res_NA_SDGE_I	0.025	-	0.1	0.1	0.1	0.1	0.1	0.1	0.1	0.1	0.2	0.2	0.3	0.3	0.4

Technology Level Adoption Definitions

The final set of adoption worksheets is used to calculate adoptions found in the Adoptions table in Figure 7-2. Currently there are a total of 15 individual tabs. There are two areas in each worksheet for entering and calculating adoptions. The top part of the worksheet takes a mathematical approach to supplying the information while the lower part is more explicit in that the user may enter exactly the values desired for adoptions in the model.

Figure 7-3 displays a copy of the adoption calculations tab. In the calculation tab, the user can manipulate the yellow cells to create a desired distribution of adoptions for any of the technologies in the model. When the cell at the top of the figure is set to the word “Calc” then the system uses the upper portion of the worksheet to develop the adoptions inputs used for the model. This is the area shown in Figure 7-3. In Figure 7-4 the User Inputs table is shown. When the word “User” is placed in the cell at the top of the tab, then the values placed in the User Inputs table are used directly by the system. In this case, since no values were entered in the user table, the system is set to use the calculated values. Figure 7-5 shows a snippet of the adoptions values that will be used for the selected technology.

These tabs may be edited to supply different adoptions by the user as appropriate for a given scenario. If the user chooses to change the values in this workbook then the batch runs must be recalculated to incorporate the changes. Alternatively the user can make their desired changes, recalculate the workbook and copy the entire contents of the Adoptions tab into the Results workbook tab with the same name. This is somewhat more complicated but a much faster way of accomplishing the task of estimating a new scenario in which only that quantity or distribution of adoptions has changed.

Figure 7-3: Adoption Calculations Tab

FC1200kW		2007	2008	2009	2010	2011	2012	2013	2014	2015	2016	2017	2018	2019	2020	
Use Calculated or User Entered Adoptions?	Calc	Enter "Calc" or "User"														
	Use?	2007	2008	2009	2010	2011	2012	2013	2014	2015	2016	2017	2018	2019	2020	
NonRes PGE Total (MW)		-	1.6	1.0	1.2	1.3	1.5	1.7	2.0	2.3	2.7	3.1	3.5	4.0	4.7	
% Increase	15%	Yes	-	1.6	1.0	1.2	1.3	1.5	1.7	2.0	2.3	2.7	3.1	3.5	4.0	4.7
User Entered		No	-	1.6	1.0	1.0	1.0	1.0	1.0	1.0	1.0	1.0	1.0	1.0	1.0	
NonRes SCE Total (MW)		1.0	2.1	1.5	1.7	1.8	2.0	2.2	2.4	2.7	2.9	3.2	3.5	3.9	4.3	
% Increase	10%	Yes	1.0	2.1	1.5	1.7	1.8	2.0	2.2	2.4	2.7	2.9	3.2	3.5	3.9	4.3
User Entered		No	1.0	2.1	1.5	1.5	1.5	1.5	1.5	1.5	1.5	1.5	1.5	1.5	1.5	
NonRes SDGE Total (MW)		0.5	0.3	-	0.3	0.4	0.4	0.5	0.6	0.7	0.9	1.1	1.3	1.5	1.9	
% Increase	20%	Yes	0.5	0.3	-	0.3	0.4	0.4	0.5	0.6	0.7	0.9	1.1	1.3	1.5	1.9
User Entered		No	0.5	0.3	-	0.5	0.5	0.5	0.5	0.5	0.5	0.5	0.5	0.5	0.5	
NonRes Statewide Total (MW)		1.5	3.9	2.5	3.1	3.5	3.9	4.5	5.0	5.7	6.5	7.3	8.3	9.5	10.8	
Calculated Values based on Yellow Cells																
	Total	NG	OSBGas	DIRBGas		NR	GNP									
PGE_C	50%	40%	30%	30%	100%	80%	20%									
PGE_I	50%	40%	30%	30%	100%	80%	20%									
SCE_C	30%	40%	30%	30%	100%	80%	20%									
SCE_I	70%	40%	30%	30%	100%	80%	20%									
SDGE_C	20%	40%	30%	30%	100%	80%	20%									
SDGE_I	80%	70%	30%	0%	100%	80%	20%									

Figure 7-4: User Inputs

User Inputs	2007	2008	2009	2010	2011	2012	2013	2014	2015	2016	2017	2018	2019	2020
User_FC1200kW_GNP_DIRBGas_PGE_C														
User_FC1200kW_GNP_NG_PGE_C														
User_FC1200kW_GNP_OSBGas_PGE_C														
User_FC1200kW_NR_DIRBGas_PGE_C														
User_FC1200kW_NR_NG_PGE_C														
User_FC1200kW_NR_OSBGas_PGE_C														
User_FC1200kW_GNP_DIRBGas_PGE_I														
User_FC1200kW_GNP_NG_PGE_I														
User_FC1200kW_GNP_OSBGas_PGE_I														
User_FC1200kW_NR_DIRBGas_PGE_I														
User_FC1200kW_NR_NG_PGE_I														
User_FC1200kW_NR_OSBGas_PGE_I														
User_FC1200kW_GNP_DIRBGas_SCE_C														
User_FC1200kW_GNP_NG_SCE_C														
User_FC1200kW_GNP_OSBGas_SCE_C														
User_FC1200kW_NR_DIRBGas_SCE_C														
User_FC1200kW_NR_NG_SCE_C														
User_FC1200kW_NR_OSBGas_SCE_C														
User_FC1200kW_GNP_DIRBGas_SCE_I														
User_FC1200kW_GNP_NG_SCE_I														
User_FC1200kW_GNP_OSBGas_SCE_I														
User_FC1200kW_NR_DIRBGas_SCE_I														
User_FC1200kW_NR_NG_SCE_I														
User_FC1200kW_NR_OSBGas_SCE_I														
User_FC1200kW_GNP_DIRBGas_SDGE_C														
User_FC1200kW_GNP_NG_SDGE_C														
User_FC1200kW_GNP_OSBGas_SDGE_C														
User_FC1200kW_NR_DIRBGas_SDGE_C														

Figure 7-5: Adoptions Used by the System

FC1200kW		2007	2008	2009	2010	2011	2012	2013	2014	2015	2016	2017	2018	2019	2020
Use Calculated or User Entered Adoption	Calc	Enter "Calc" or "User"													
Calc_FC1200kW_GNP_DIRBGas_PGE_C	3.0%	0.0	0.0	0.0	0.0	0.0	0.0	0.1	0.1	0.1	0.1	0.1	0.1	0.1	0.1
Calc_FC1200kW_GNP_NG_PGE_C	4.0%	0.0	0.1	0.0	0.0	0.1	0.1	0.1	0.1	0.1	0.1	0.1	0.1	0.1	0.2
Calc_FC1200kW_GNP_OSBGas_PGE_C	3.0%	0.0	0.0	0.0	0.0	0.0	0.0	0.1	0.1	0.1	0.1	0.1	0.1	0.1	0.1
Calc_FC1200kW_NR_DIRBGas_PGE_C	12.0%	0.0	0.2	0.1	0.1	0.2	0.2	0.2	0.2	0.3	0.3	0.4	0.4	0.5	0.6
Calc_FC1200kW_NR_NG_PGE_C	16.0%	0.0	0.2	0.2	0.2	0.2	0.2	0.3	0.3	0.4	0.4	0.5	0.5	0.6	0.7
Calc_FC1200kW_NR_OSBGas_PGE_C	12.0%	0.0	0.2	0.1	0.1	0.2	0.2	0.2	0.2	0.3	0.3	0.4	0.4	0.5	0.6
Calc_FC1200kW_GNP_DIRBGas_PGE_I	3.0%	0.0	0.0	0.0	0.0	0.0	0.0	0.1	0.1	0.1	0.1	0.1	0.1	0.1	0.1
Calc_FC1200kW_GNP_NG_PGE_I	4.0%	0.0	0.1	0.0	0.0	0.1	0.1	0.1	0.1	0.1	0.1	0.1	0.1	0.1	0.2
Calc_FC1200kW_GNP_OSBGas_PGE_I	3.0%	0.0	0.0	0.0	0.0	0.0	0.0	0.1	0.1	0.1	0.1	0.1	0.1	0.1	0.1
Calc_FC1200kW_NR_DIRBGas_PGE_I	12.0%	0.0	0.2	0.1	0.1	0.2	0.2	0.2	0.2	0.3	0.3	0.4	0.4	0.5	0.6
Calc_FC1200kW_NR_NG_PGE_I	16.0%	0.0	0.2	0.2	0.2	0.2	0.2	0.3	0.3	0.4	0.4	0.5	0.5	0.6	0.7
Calc_FC1200kW_NR_OSBGas_PGE_I	12.0%	0.0	0.2	0.1	0.1	0.2	0.2	0.2	0.2	0.3	0.3	0.4	0.4	0.5	0.6
Calc_FC1200kW_GNP_DIRBGas_SCE_C	1.8%	0.0	0.0	0.0	0.0	0.0	0.0	0.0	0.0	0.0	0.1	0.1	0.1	0.1	0.1
Calc_FC1200kW_GNP_NG_SCE_C	2.4%	0.0	0.1	0.0	0.0	0.0	0.0	0.1	0.1	0.1	0.1	0.1	0.1	0.1	0.1
Calc_FC1200kW_GNP_OSBGas_SCE_C	1.8%	0.0	0.0	0.0	0.0	0.0	0.0	0.0	0.0	0.0	0.1	0.1	0.1	0.1	0.1
Calc_FC1200kW_NR_DIRBGas_SCE_C	7.2%	0.1	0.2	0.1	0.1	0.1	0.1	0.1	0.2	0.2	0.2	0.2	0.3	0.3	0.3
Calc_FC1200kW_NR_NG_SCE_C	9.6%	0.1	0.2	0.1	0.2	0.2	0.2	0.2	0.2	0.3	0.3	0.3	0.3	0.4	0.4
Calc_FC1200kW_NR_OSBGas_SCE_C	7.2%	0.1	0.2	0.1	0.1	0.1	0.1	0.2	0.2	0.2	0.2	0.2	0.3	0.3	0.3
Calc_FC1200kW_GNP_DIRBGas_SCE_I	4.2%	0.0	0.1	0.1	0.1	0.1	0.1	0.1	0.1	0.1	0.1	0.1	0.1	0.1	0.2
Calc_FC1200kW_GNP_NG_SCE_I	5.6%	0.1	0.1	0.1	0.1	0.1	0.1	0.1	0.1	0.1	0.2	0.2	0.2	0.2	0.2
Calc_FC1200kW_GNP_OSBGas_SCE_I	4.2%	0.0	0.1	0.1	0.1	0.1	0.1	0.1	0.1	0.1	0.1	0.1	0.1	0.1	0.2
Calc_FC1200kW_NR_DIRBGas_SCE_I	16.8%	0.2	0.4	0.3	0.3	0.3	0.3	0.4	0.4	0.4	0.5	0.5	0.6	0.7	0.7
Calc_FC1200kW_NR_NG_SCE_I	22.4%	0.2	0.5	0.3	0.4	0.4	0.4	0.5	0.5	0.6	0.7	0.7	0.8	0.9	1.0
Calc_FC1200kW_NR_OSBGas_SCE_I	16.8%	0.2	0.4	0.3	0.3	0.3	0.3	0.4	0.4	0.4	0.5	0.5	0.6	0.7	0.7
Calc_FC1200kW_GNP_DIRBGas_SDGE_C	1.2%	0.0	0.0	0.0	0.0	0.0	0.0	0.0	0.0	0.0	0.0	0.0	0.0	0.0	0.0
Calc_FC1200kW_GNP_NG_SDGE_C	1.6%	0.0	0.0	0.0	0.0	0.0	0.0	0.0	0.0	0.0	0.0	0.0	0.0	0.0	0.0
Calc_FC1200kW_GNP_OSBGas_SDGE_C	1.2%	0.0	0.0	0.0	0.0	0.0	0.0	0.0	0.0	0.0	0.0	0.0	0.0	0.0	0.0
Calc_FC1200kW_NR_DIRBGas_SDGE_C	4.8%	0.0	0.0	0.0	0.0	0.0	0.0	0.0	0.0	0.0	0.0	0.1	0.1	0.1	0.1
Calc_FC1200kW_NR_NG_SDGE_C	6.4%	0.0	0.0	0.0	0.0	0.0	0.0	0.0	0.0	0.0	0.0	0.1	0.1	0.1	0.1
Calc_FC1200kW_NR_OSBGas_SDGE_C	4.8%	0.0	0.0	0.0	0.0	0.0	0.0	0.0	0.0	0.0	0.0	0.1	0.1	0.1	0.1
Calc_FC1200kW_GNP_DIRBGas_SDGE_I	0.0%	0.0	0.0	0.0	0.0	0.0	0.0	0.0	0.0	0.0	0.0	0.0	0.0	0.0	0.0
Calc_FC1200kW_GNP_NG_SDGE_I	11.2%	0.1	0.0	0.0	0.0	0.0	0.0	0.1	0.1	0.1	0.1	0.1	0.1	0.2	0.2
Calc_FC1200kW_GNP_OSBGas_SDGE_I	4.8%	0.0	0.0	0.0	0.0	0.0	0.0	0.0	0.0	0.0	0.0	0.1	0.1	0.1	0.1
Calc_FC1200kW_NR_DIRBGas_SDGE_I	0.0%	0.0	0.0	0.0	0.0	0.0	0.0	0.0	0.0	0.0	0.0	0.0	0.0	0.0	0.0

7.3.2 Avoided Cost

The avoided costs used by the system are stored in four different workbooks. There are two workbooks for the electric avoided cost and two for the gas avoided cost. The suffix *High* on the filename implies that the avoided costs stored in the workbook are considered to be the high

scenario run from the E3 avoided cost workbooks from which the data were generated.¹ The workbooks without the suffix are the middle run from the same workbook.

Figure 7-6: Electric Avoided Cost

Wtd Ave AC		Do not format cells with this color background														
		89.216319 51.2328989 73.7755148 84.2356714 88.8091777 92.4549244 97.1046079 99.9256994 103.098917 106.382594 109.771217 113.155654 127.874374 131.261462														
		Avoided Costs (\$/MWh)														
Date	Hour	From TP KW	2008	2009	2010	2011	2012	2013	2014	2015	2016	2017	2018	2019	2020	2021
1/1/2009	0	1	\$70.09	\$35.87	\$53.53	\$60.83	\$63.09	\$64.55	\$64.38	\$53.58	\$55.72	\$57.98	\$60.30	\$62.61	\$76.20	\$78.44
1/1/2009	1	1	\$67.62	\$34.70	\$51.71	\$58.76	\$60.95	\$62.38	\$62.26	\$51.92	\$54.02	\$56.24	\$58.53	\$60.80	\$74.36	\$76.57
1/1/2009	2	1	\$65.59	\$33.74	\$50.22	\$57.06	\$59.20	\$60.60	\$60.52	\$50.55	\$52.63	\$54.82	\$57.08	\$59.32	\$72.85	\$75.03
1/1/2009	3	1	\$64.61	\$33.27	\$49.50	\$56.23	\$58.35	\$59.74	\$59.68	\$49.89	\$51.96	\$54.13	\$56.37	\$58.61	\$72.12	\$74.29
1/1/2009	4	1	\$65.05	\$33.48	\$49.83	\$56.61	\$58.73	\$60.13	\$60.07	\$50.19	\$52.26	\$54.44	\$56.69	\$58.93	\$72.46	\$74.63
1/1/2009	5	1	\$66.43	\$34.13	\$50.84	\$57.76	\$59.92	\$61.34	\$61.24	\$51.11	\$53.20	\$55.41	\$57.68	\$59.93	\$73.48	\$75.67
1/1/2009	6	1	\$66.48	\$34.16	\$50.87	\$57.80	\$59.96	\$61.38	\$61.28	\$51.15	\$53.24	\$55.44	\$57.71	\$59.97	\$73.51	\$75.71
1/1/2009	7	1	\$66.31	\$34.08	\$50.75	\$57.66	\$59.82	\$61.24	\$61.14	\$51.04	\$53.13	\$55.33	\$57.59	\$59.85	\$73.39	\$75.58
1/1/2009	8	1	\$69.03	\$35.37	\$52.75	\$59.94	\$62.17	\$63.62	\$63.47	\$52.87	\$54.99	\$57.23	\$59.54	\$61.83	\$75.41	\$77.64
1/1/2009	9	1	\$71.46	\$36.52	\$54.54	\$61.98	\$64.27	\$65.75	\$65.55	\$54.50	\$56.66	\$58.94	\$61.28	\$63.60	\$77.21	\$79.47
1/1/2009	10	1	\$73.00	\$37.24	\$55.66	\$63.26	\$65.60	\$67.10	\$66.86	\$55.54	\$57.71	\$60.01	\$62.37	\$64.72	\$78.35	\$80.63
1/1/2009	11	1	\$73.39	\$37.43	\$55.96	\$63.60	\$65.94	\$67.45	\$67.20	\$55.80	\$57.99	\$60.29	\$62.66	\$65.01	\$78.65	\$80.93
1/1/2009	12	1	\$72.90	\$37.20	\$55.59	\$63.18	\$65.51	\$67.01	\$66.78	\$55.47	\$57.65	\$59.94	\$62.30	\$64.65	\$78.28	\$80.56
1/1/2009	13	1	\$72.20	\$36.87	\$55.08	\$62.59	\$64.91	\$66.40	\$66.18	\$55.00	\$57.16	\$59.45	\$61.80	\$64.14	\$77.76	\$80.03
1/1/2009	14	1	\$71.59	\$36.58	\$54.63	\$62.09	\$64.38	\$65.87	\$65.66	\$54.59	\$56.75	\$59.03	\$61.37	\$63.70	\$77.31	\$79.57
1/1/2009	15	1	\$72.21	\$36.87	\$55.09	\$62.60	\$64.92	\$66.41	\$66.19	\$55.01	\$57.17	\$59.46	\$61.81	\$64.15	\$77.77	\$80.04
1/1/2009	16	1	\$77.25	\$39.26	\$58.79	\$66.83	\$69.27	\$70.82	\$70.50	\$58.40	\$60.63	\$62.99	\$65.41	\$67.82	\$81.51	\$83.84
1/1/2009	17	1	\$85.70	\$43.46	\$65.15	\$74.07	\$76.76	\$78.47	\$78.06	\$100.52	\$103.69	\$106.98	\$110.37	\$113.75	\$128.47	\$131.85
1/1/2009	18	1	\$85.13	\$43.17	\$64.72	\$73.57	\$76.25	\$77.94	\$77.54	\$99.85	\$103.00	\$106.26	\$109.63	\$112.99	\$127.68	\$131.04
1/1/2009	19	1	\$83.55	\$42.37	\$63.52	\$72.21	\$74.84	\$76.50	\$76.11	\$62.95	\$65.32	\$67.83	\$70.40	\$72.96	\$86.80	\$89.29
1/1/2009	20	1	\$81.04	\$41.10	\$61.61	\$70.04	\$72.59	\$74.20	\$73.82	\$61.06	\$63.36	\$65.79	\$68.29	\$70.77	\$84.53	\$86.94
1/1/2009	21	1	\$76.59	\$38.95	\$58.31	\$66.28	\$68.70	\$70.25	\$69.94	\$57.96	\$60.18	\$62.53	\$64.95	\$67.35	\$81.03	\$83.35
1/1/2009	22	1	\$72.28	\$36.91	\$55.14	\$62.66	\$64.98	\$66.47	\$66.25	\$55.05	\$57.22	\$59.51	\$61.86	\$64.20	\$77.82	\$80.09
1/1/2009	23	1	\$67.04	\$34.42	\$51.28	\$58.27	\$60.45	\$61.87	\$61.76	\$51.52	\$53.62	\$55.83	\$58.11	\$60.38	\$73.93	\$76.13
1/2/2009	0	1	\$59.41	\$30.81	\$45.67	\$51.87	\$53.85	\$55.18	\$55.23	\$46.38	\$48.39	\$50.49	\$52.66	\$54.81	\$68.26	\$70.36
1/2/2009	1	1	\$59.61	\$30.90	\$45.82	\$52.04	\$54.03	\$55.36	\$55.40	\$46.52	\$48.53	\$50.63	\$52.80	\$54.96	\$68.42	\$70.51
1/2/2009	2	1	\$58.71	\$30.48	\$45.17	\$51.29	\$53.26	\$54.57	\$54.64	\$45.92	\$47.91	\$50.00	\$52.16	\$54.31	\$67.75	\$69.84
1/2/2009	3	1	\$58.70	\$30.47	\$45.16	\$51.28	\$53.25	\$54.56	\$54.63	\$45.91	\$47.90	\$49.99	\$52.15	\$54.30	\$67.74	\$69.83
1/2/2009	4	1	\$60.52	\$31.33	\$46.49	\$52.81	\$54.82	\$56.16	\$56.19	\$47.14	\$49.15	\$51.27	\$53.45	\$55.63	\$69.09	\$71.21
1/2/2009	5	1	\$62.34	\$32.19	\$47.83	\$54.33	\$56.39	\$57.75	\$57.74	\$48.36	\$50.40	\$52.54	\$54.75	\$56.95	\$70.44	\$72.58
1/2/2009	6	1	\$67.65	\$34.71	\$51.73	\$58.78	\$60.97	\$62.41	\$62.28	\$51.93	\$54.04	\$56.26	\$58.55	\$60.82	\$74.38	\$76.59
1/2/2009	7	1	\$70.31	\$35.97	\$53.69	\$61.01	\$63.27	\$64.74	\$64.56	\$53.72	\$55.87	\$58.13	\$60.45	\$62.76	\$76.36	\$78.60

The electric avoided costs, depicted in Figure 7-6 above, come in a workbook that is divided into tabs by utility and climate region. There are six tabs in this workbook, with two tabs for each utility that represent the coastal and inland regions for each. When the simulations are running the production curve is posted into the column labeled KW. The workbook recalculates using these values and then the line labeled “Wtd Ave AC” is copied out and pasted into the AnnualInputs tab in the Calc Engine. The system is designed to know which tab is appropriate given the utility and climate region that is assigned to the technology being run.

Figure 7-7: Gas Avoided Cost

Wtd Ave AC		Do not format cells with this color background														
Wtd Ave AC Therms Req'd		1.066225 0.61716 0.729704 0.807292 0.860524 0.905153 0.961917 0.991204 1.04529 1.099682 1.156489 1.209116 1.260982 1.314987														
Wtd Ave AC Therms Out		1.066225 0.61716 0.729704 0.807292 0.860524 0.905153 0.961917 0.991204 1.04529 1.099682 1.156489 1.209116 1.260982 1.314987														
Month	From TP Therms Req'd	From TP Therms Out	2008	2009	2010	2011	2012	2013	2014	2015	2016	2017	2018	2019	2020	2021
January	1	1	\$1.14	\$0.89	\$1.01	\$0.97	\$1.05	\$1.10	\$1.16	\$1.21	\$1.27	\$1.33	\$1.39	\$1.45	\$1.50	\$1.56
February	1	1	\$1.19	\$0.81	\$0.94	\$0.97	\$1.05	\$1.10	\$1.16	\$1.20	\$1.26	\$1.32	\$1.38	\$1.44	\$1.50	\$1.55
March	1	1	\$1.29	\$0.75	\$0.88	\$0.96	\$1.03	\$1.08	\$1.14	\$1.18	\$1.23	\$1.29	\$1.35	\$1.41	\$1.47	\$1.53
April	1	1	\$1.13	\$0.44	\$0.55	\$0.67	\$0.72	\$0.76	\$0.81	\$0.83	\$0.88	\$0.93	\$0.98	\$1.03	\$1.08	\$1.13
May	1	1	\$1.21	\$0.47	\$0.57	\$0.67	\$0.72	\$0.76	\$0.81	\$0.83	\$0.88	\$0.93	\$0.98	\$1.03	\$1.08	\$1.13
June	1	1	\$1.32	\$0.42	\$0.58	\$0.68	\$0.72	\$0.76	\$0.82	\$0.84	\$0.89	\$0.94	\$0.99	\$1.04	\$1.09	\$1.14
July	1	1	\$1.19	\$0.44	\$0.59	\$0.68	\$0.73	\$0.77	\$0.82	\$0.85	\$0.90	\$0.95	\$1.00	\$1.05	\$1.10	\$1.15
August	1	1	\$0.91	\$0.44	\$0.60	\$0.69	\$0.73	\$0.78	\$0.83	\$0.85	\$0.90	\$0.95	\$1.01	\$1.06	\$1.11	\$1.16
September	1	1	\$0.77	\$0.45	\$0.60	\$0.69	\$0.74	\$0.78	\$0.83	\$0.86	\$0.91	\$0.96	\$1.01	\$1.06	\$1.11	\$1.16
October	1	1	\$0.74	\$0.59	\$0.61	\$0.70	\$0.75	\$0.79	\$0.85	\$0.87	\$0.92	\$0.97	\$1.02	\$1.07	\$1.12	\$1.17
November	1	1	\$0.96	\$0.78	\$0.89	\$0.98	\$1.03	\$1.08	\$1.14	\$1.18	\$1.24	\$1.30	\$1.36	\$1.42	\$1.47	\$1.53
December	1	1	\$0.96	\$0.94	\$0.93	\$1.01	\$1.06	\$1.11	\$1.17	\$1.21	\$1.27	\$1.33	\$1.39	\$1.45	\$1.51	\$1.57

¹ The electric avoided costs used in the SGIPce model are derived from the avoided cost workbook provided by E3 named SGIP_2009ElecAvoidedCostModule_5-4-2010_fix.xls.

The gas avoided costs, shown in Figure 7-7, are also divided into tabs but the division is slightly different. There are two sets of tabs in the workbook. The first set contains avoided costs representing the gas avoided costs associated with avoided commodity, emissions, and Transmission and Distribution. These tabs are setup by utility and climate region. There are two tabs for each utility; one for the coastal region and one for the inland region. The second set of tabs has the suffix *_PA* and represent the gas avoided costs to be used for the Program Administrator (PA) cost-effectiveness tests.

The gas avoided costs are calculated separately for residential and non-residential customers for two reasons. First, the avoided emissions values depend on the site's specific gas usage. The E3 gas avoided costs workbooks specify a furnace for the residential sector and a boiler for the non-residential sector. Secondly, the gas avoided costs are divided into avoided costs needed for the total resource cost test and gas avoided costs needed for the PA test. The non-residential sector has been modeled as non-core natural gas customers while the residential sector is modeled as core natural gas customers. For the residential sector, the gas avoided costs needed for the TRC test and the PA test are identical. For the non-residential sector, the two values differ due to the non-core nature of the non-residential customers. The non-residential TRC gas avoided costs include the commodity, emissions, and transmission and distribution avoided costs. The non-core, non-residential PA gas avoided costs, however, are zero. The utility is not responsible for the commodity, emission, or planning for the transmission or distribution for these customers.

As with the electric workbooks, the monthly gas profiles are pasted into their respective columns (i.e., "Therms Req'd" or "Therms Out") and the worksheet is recalculated. The two rows labeled "Wtd Ave AC Therms Req'd" and "Wtd Ave AC Therms Out" are then copied into the Calc Engine for use in the simulation.

7.3.3 Global

The Global workbook consists of three tabs: *Global_Financing*, *Global_Inputs*, and *Global_Constants*. The data on these tabs are not technology-specific so they have been placed in a separate workbook to reduce redundancy. This section will discuss the various worksheets in the Global workbook and how these sheets contribute to the system inputs.

Global Financing

The Global Financing sheet, seen in Figure 7-8, makes available the financing inputs needed by the model. These data can be sector-specific, so the system places a sector identifier in the upper left corner of the sheet to indicate which sector is being run. The workbook is recalculated and the appropriate values are collected to supply the system with the needed financing information. If the PPA option is selected then the inputs are taken from the top table labeled PPA/Commercial. If the Debt/Equity financing option is selected then the second table is selected. The data in the last table in Figure 7-8 are also sector-specific. The appropriate

columns of data are selected from this table and used in the other tables based on the sector being analyzed at the time.

Figure 7-8: Global Financing

NR	= Can be: RES, NR, GNP																			
	NR	Override	2007	2008	2009	2010	2011	2012	2013	2014	2015	2016	2017	2018	2019	2020				
PPA/Commercial			Override	2007	2008	2009	2010	2011	2012	2013	2014	2015	2016	2017	2018	2019	2020			
Federal Tax Rate		35%	35%	35%	35%	35%	35%	35%	35%	35%	35%	35%	35%	35%	35%	35%	35%			
State Tax Rate		8.84%	8.84%	8.84%	8.84%	8.84%	8.84%	8.84%	8.84%	8.84%	8.84%	8.84%	8.84%	8.84%	8.84%	8.84%	8.84%			
Apply Tax Credit		1	1	1	1	1	1	1	1	1	1	1	1	1	1	1	1			
Percent financed with Equity		60.00%	60%	60%	60%	60%	60%	60%	60%	60%	60%	60%	60%	60%	60%	60%	60%			
Debt Interest Rate		7.67%	8%	8%	8%	8%	8%	8%	8%	8%	8%	8%	8%	8%	8%	8%	8%			
Target DSCR		1.40	1.40	1.40	1.40	1.40	1.40	1.40	1.40	1.40	1.40	1.40	1.40	1.40	1.40	1.40	1.40			
Years of Debt Service in DSRF		1.00	1	1	1	1	1	1	1	1	1	1	1	1	1	1	1			
WACC		8.25%	8.25%	8.25%	8.25%	8.25%	8.25%	8.25%	8.25%	8.25%	8.25%	8.25%	8.25%	8.25%	8.25%	8.25%	8.25%			
Debt/Equity			Override	2007	2008	2009	2010	2011	2012	2013	2014	2015	2016	2017	2018	2019	2020			
Federal Tax Rate		35%	35%	35%	35%	35%	35%	35%	35%	35%	35%	35%	35%	35%	35%	35%	35%			
State Tax Rate		8.84%	8.84%	8.84%	8.84%	8.84%	8.84%	8.84%	8.84%	8.84%	8.84%	8.84%	8.84%	8.84%	8.84%	8.84%	8.84%			
Apply Tax Credit		1	1	1	1	1	1	1	1	1	1	1	1	1	1	1	1			
Percent financed with Equity		60%	60%	60%	60%	60%	60%	60%	60%	60%	60%	60%	60%	60%	60%	60%	60%			
Debt Interest Rate		8%	8%	8%	8%	8%	8%	8%	8%	8%	8%	8%	8%	8%	8%	8%	8%			
Target DSCR		1.4	1.4	1.4	1.4	1.4	1.4	1.4	1.4	1.4	1.4	1.4	1.4	1.4	1.4	1.4	1.4			
Years of Debt Service in DSRF		1	1	1	1	1	1	1	1	1	1	1	1	1	1	1	1			
WACC		8.25%	8.25%	8.25%	8.25%	8.25%	8.25%	8.25%	8.25%	8.25%	8.25%	8.25%	8.25%	8.25%	8.25%	8.25%	8.25%			
Cost of Equity		10.72%	10.72%	10.72%	10.72%	10.72%	10.72%	10.72%	10.72%	10.72%	10.72%	10.72%	10.72%	10.72%	10.72%	10.72%	10.72%			
Finance rate																				
Reinvestment rate																				
			Residential	Commercial	Government															
Inputs for Debt/Equity			RES	NR	GNP															
Federal Tax Rate			20.00%	35.00%	0.00%															
State Tax Rate			9.30%	8.84%	0.00%															
Apply Tax Credit			1	1	0															
Percent financed with Equity			40.00%	60.00%	40.00%															
Debt Interest Rate			5.50%	7.67%	4.21%															
Target DSCR			0	1.4	0															
Years of Debt Service in DSRF			0	1	0															
WACC			4.36%	8.25%	4.21%															
Cost of Equity			5.50%	10.72%	4.21%															
Utility Discount Rate			0.0865	0.0865	0.0865															
Societal Discount Rate			0.0506	0.0506	0.0506															

Global Inputs

The Global Inputs tab, shown in Figure 7-9 below, supplies annual inputs for a number of global variables. The first set of values supply first-year values for Insurance, Inflation, and O&M escalation. The second set of values supply annual values for Emission Costs and Electric and Gas price multipliers for the Greenhouse Gas scenario. The values in these tables are taken as-is and supplied to the system.

Figure 7-9: Global Inputs

Annual Inputs										
Do not format cells formatted with this color										
Name	2007	2008	2009	2010	2011	2012	2013	2014	2015	2016
Insurance Expense Multiplier (%)	0.005	0.005	0.005	0.005	0.005	0.005	0.005	0.005	0.005	0.005
Insurance Escalator (%/yr)	0.02	0.02	0.02	0.02	0.02	0.02	0.02	0.02	0.02	0.02
Inflation Rate (%)	0.02	0.02	0.02	0.02	0.02	0.02	0.02	0.02	0.02	0.02
O&M Escalation Rate (%)	0.02	0.02	0.02	0.02	0.02	0.02	0.02	0.02	0.02	0.02
Emission Cost Nominal \$										
NOx \$/lb	4.628571	4.628571	4.628571	5.29	5.819	6.4009	7.04099	7.745089	8.519598	9.371558
PM10 \$/lb	6.474959	6.474959	6.474959	7.400239	8.140263	8.954289	9.849718	10.83469	11.91816	13.10997
CO2 \$/ton	10.53174	11.57547	12.72264	13.98349	15.36929	16.89244	19.87226	22.84736	26.05302	29.25587
CO2 High \$/ton	24.013	25.70997	27.52687	29.47216	31.55492	33.78487	37.10255	40.42225	43.97941	47.54078
Electric Price Multipliers for GHG										
PG&E Coastal Region	1.077629	1.159047	1.111623	1.102767	1.103549	1.10562	1.108022	1.132386	1.12985	1.127295
PG&E Inland Region	1.077629	1.159047	1.111623	1.102767	1.103549	1.10562	1.108022	1.132386	1.12985	1.127295
SCE Coastal Region	1.076814	1.163235	1.114502	1.103298	1.102588	1.103941	1.105994	1.131461	1.128949	1.126439
SCE Inland Region	1.07698	1.162358	1.1139	1.103188	1.102783	1.104281	1.106403	1.13165	1.129132	1.126614
SDG&E Coastal Region	1.07699	1.163645	1.1148	1.103544	1.102815	1.104162	1.106211	1.131731	1.129208	1.126689
SDG&E Inland Region	1.076805	1.163282	1.114534	1.103303	1.102577	1.103922	1.105972	1.131451	1.128939	1.12643
Gas Price Multipliers for GHG										
PG&E Non-residential	1.073967	1.13398	1.118685	1.112238	1.110033	1.109176	1.104788	1.103725	1.100326	1.097271
PG&E Residential	1.071791	1.12726	1.113569	1.107447	1.105314	1.104405	1.100163	1.098958	1.095623	1.092606
SCE Non-residential	1.085033	1.162931	1.136059	1.126905	1.123083	1.122409	1.118421	1.111184	1.107315	1.103853
SCE Residential	1.081143	1.149664	1.126977	1.118768	1.115326	1.114626	1.110849	1.104223	1.100554	1.097245
SDG&E Non-residential	1.082843	1.154756	1.130487	1.122155	1.118693	1.118133	1.114385	1.107604	1.103953	1.100679
SDPG&E Residential	1.078419	1.140436	1.120456	1.113165	1.11013	1.109569	1.106078	1.099974	1.096567	1.093486

Global Constants

Figure 7-10 shows a few global constants that are used by the system. These values are constant across all technologies unless otherwise indicated. When they do vary by technology a comment in the workbook explains how they change and for what technologies. These specific assignments are made in the code and cannot be changed by the user. As these are generally rates that do not change over time, they are simply copied as-is from this table and supplied to the system for use in the calculations. The Utility and Societal Discount Rates are used to calculate the levelized values in the LCOE worksheet. The Demand Savings Ratio is used to estimate the value of demand given the levels of kWh for a given rate. The value of this variable is 80% for all technologies except PV and Wind, where the code sets it to zero for these technologies.

Figure 7-10: Global Constants

Constants	
Name	Value
Utility Discount Rate	8.65%
Societal Discount Rate	5.06%
Demand Savings Ratio	80.0%

7.3.4 Rates

The electric rates used by the system are stored in a number of workbooks. For the non-residential rates it was necessary, due to memory constraints, to create a separate workbook for

each rate and have the system open the appropriate workbook for each iteration through the list of selected technologies. For the residential sector it was possible to keep all the electric rate definitions in one workbook.

Non-Residential Electric Rates

In Figure 7-11 the Calculation worksheet is presented. This is the worksheet that calculates the data needed by the system to develop the inputs used by the system. Whilst unnecessary for non-residential rates, in the upper left corner of the sheet the system places the utility and rate identifiers in the two labeled cells for the technology being run. The demand ratio, used for calculating the demand portion of the rate, is placed in the cell identified for that purpose. Finally, the system pastes the 8,760 production curve in the column labeled “KW”. Once these data are in place the workbook is recalculated and the values used in the calculation of rates are copied from the line labeled “Wtd Ave Utility Rate” at the top of the worksheet and pasted into the Calc Engine for use by the system.

Figure 7-11: Electric Rate Calculation Worksheet

Utility	PGE	Demand Savings Ratio	0.8	Wtd Ave Utility Rate Do not format cells with this fill color												
Rate	A10TOU			0.146198	0.134464	0.136244	0.13396	0.137979	0.142119	0.146383	0.150774	0.155298	0.161312	0.16756		
		From Rates	From Rates	From TP	Rate											
Date	Hour	Peak	Season	KW	2007	2008	2009	2010	2011	2012	2013	2014	2015	2016	2017	
1/1/2009	0	Off	Winter	600	\$0.1148	\$0.1053	\$0.1064	\$0.1043	\$0.1075	\$0.1107	\$0.1140	\$0.1174	\$0.1209	\$0.1256	\$0.1305	
1/1/2009	1	Off	Winter	600	\$0.1148	\$0.1053	\$0.1064	\$0.1043	\$0.1075	\$0.1107	\$0.1140	\$0.1174	\$0.1209	\$0.1256	\$0.1305	
1/1/2009	2	Off	Winter	600	\$0.1148	\$0.1053	\$0.1064	\$0.1043	\$0.1075	\$0.1107	\$0.1140	\$0.1174	\$0.1209	\$0.1256	\$0.1305	
1/1/2009	3	Off	Winter	600	\$0.1148	\$0.1053	\$0.1064	\$0.1043	\$0.1075	\$0.1107	\$0.1140	\$0.1174	\$0.1209	\$0.1256	\$0.1305	
1/1/2009	4	Off	Winter	600	\$0.1148	\$0.1053	\$0.1064	\$0.1043	\$0.1075	\$0.1107	\$0.1140	\$0.1174	\$0.1209	\$0.1256	\$0.1305	
1/1/2009	5	Off	Winter	600	\$0.1148	\$0.1053	\$0.1064	\$0.1043	\$0.1075	\$0.1107	\$0.1140	\$0.1174	\$0.1209	\$0.1256	\$0.1305	
1/1/2009	6	Off	Winter	600	\$0.1148	\$0.1053	\$0.1064	\$0.1043	\$0.1075	\$0.1107	\$0.1140	\$0.1174	\$0.1209	\$0.1256	\$0.1305	
1/1/2009	7	Off	Winter	600	\$0.1148	\$0.1053	\$0.1064	\$0.1043	\$0.1075	\$0.1107	\$0.1140	\$0.1174	\$0.1209	\$0.1256	\$0.1305	
1/1/2009	8	Off	Winter	600	\$0.1148	\$0.1053	\$0.1064	\$0.1043	\$0.1075	\$0.1107	\$0.1140	\$0.1174	\$0.1209	\$0.1256	\$0.1305	
1/1/2009	9	Off	Winter	600	\$0.1148	\$0.1053	\$0.1064	\$0.1043	\$0.1075	\$0.1107	\$0.1140	\$0.1174	\$0.1209	\$0.1256	\$0.1305	
1/1/2009	10	Off	Winter	600	\$0.1148	\$0.1053	\$0.1064	\$0.1043	\$0.1075	\$0.1107	\$0.1140	\$0.1174	\$0.1209	\$0.1256	\$0.1305	
1/1/2009	11	Off	Winter	600	\$0.1148	\$0.1053	\$0.1064	\$0.1043	\$0.1075	\$0.1107	\$0.1140	\$0.1174	\$0.1209	\$0.1256	\$0.1305	
1/1/2009	12	Off	Winter	600	\$0.1148	\$0.1053	\$0.1064	\$0.1043	\$0.1075	\$0.1107	\$0.1140	\$0.1174	\$0.1209	\$0.1256	\$0.1305	
1/1/2009	13	Off	Winter	600	\$0.1148	\$0.1053	\$0.1064	\$0.1043	\$0.1075	\$0.1107	\$0.1140	\$0.1174	\$0.1209	\$0.1256	\$0.1305	
1/1/2009	14	Off	Winter	600	\$0.1148	\$0.1053	\$0.1064	\$0.1043	\$0.1075	\$0.1107	\$0.1140	\$0.1174	\$0.1209	\$0.1256	\$0.1305	
1/1/2009	15	Off	Winter	600	\$0.1148	\$0.1053	\$0.1064	\$0.1043	\$0.1075	\$0.1107	\$0.1140	\$0.1174	\$0.1209	\$0.1256	\$0.1305	
1/1/2009	16	Off	Winter	600	\$0.1148	\$0.1053	\$0.1064	\$0.1043	\$0.1075	\$0.1107	\$0.1140	\$0.1174	\$0.1209	\$0.1256	\$0.1305	
1/1/2009	17	Off	Winter	600	\$0.1148	\$0.1053	\$0.1064	\$0.1043	\$0.1075	\$0.1107	\$0.1140	\$0.1174	\$0.1209	\$0.1256	\$0.1305	
1/1/2009	18	Off	Winter	600	\$0.1148	\$0.1053	\$0.1064	\$0.1043	\$0.1075	\$0.1107	\$0.1140	\$0.1174	\$0.1209	\$0.1256	\$0.1305	
1/1/2009	19	Off	Winter	600	\$0.1148	\$0.1053	\$0.1064	\$0.1043	\$0.1075	\$0.1107	\$0.1140	\$0.1174	\$0.1209	\$0.1256	\$0.1305	
1/1/2009	20	Off	Winter	600	\$0.1148	\$0.1053	\$0.1064	\$0.1043	\$0.1075	\$0.1107	\$0.1140	\$0.1174	\$0.1209	\$0.1256	\$0.1305	
1/1/2009	21	Off	Winter	600	\$0.1148	\$0.1053	\$0.1064	\$0.1043	\$0.1075	\$0.1107	\$0.1140	\$0.1174	\$0.1209	\$0.1256	\$0.1305	
1/1/2009	22	Off	Winter	600	\$0.1148	\$0.1053	\$0.1064	\$0.1043	\$0.1075	\$0.1107	\$0.1140	\$0.1174	\$0.1209	\$0.1256	\$0.1305	
1/1/2009	23	Off	Winter	600	\$0.1148	\$0.1053	\$0.1064	\$0.1043	\$0.1075	\$0.1107	\$0.1140	\$0.1174	\$0.1209	\$0.1256	\$0.1305	
1/2/2009	0	Off	Winter	600	\$0.1148	\$0.1053	\$0.1064	\$0.1043	\$0.1075	\$0.1107	\$0.1140	\$0.1174	\$0.1209	\$0.1256	\$0.1305	
1/2/2009	1	Off	Winter	600	\$0.1148	\$0.1053	\$0.1064	\$0.1043	\$0.1075	\$0.1107	\$0.1140	\$0.1174	\$0.1209	\$0.1256	\$0.1305	
1/2/2009	2	Off	Winter	600	\$0.1148	\$0.1053	\$0.1064	\$0.1043	\$0.1075	\$0.1107	\$0.1140	\$0.1174	\$0.1209	\$0.1256	\$0.1305	
1/2/2009	3	Off	Winter	600	\$0.1148	\$0.1053	\$0.1064	\$0.1043	\$0.1075	\$0.1107	\$0.1140	\$0.1174	\$0.1209	\$0.1256	\$0.1305	
1/2/2009	4	Off	Winter	600	\$0.1148	\$0.1053	\$0.1064	\$0.1043	\$0.1075	\$0.1107	\$0.1140	\$0.1174	\$0.1209	\$0.1256	\$0.1305	
1/2/2009	5	Off	Winter	600	\$0.1148	\$0.1053	\$0.1064	\$0.1043	\$0.1075	\$0.1107	\$0.1140	\$0.1174	\$0.1209	\$0.1256	\$0.1305	
1/2/2009	6	Off	Winter	600	\$0.1148	\$0.1053	\$0.1064	\$0.1043	\$0.1075	\$0.1107	\$0.1140	\$0.1174	\$0.1209	\$0.1256	\$0.1305	
1/2/2009	7	Off	Winter	600	\$0.1148	\$0.1053	\$0.1064	\$0.1043	\$0.1075	\$0.1107	\$0.1140	\$0.1174	\$0.1209	\$0.1256	\$0.1305	
1/2/2009	8	Off	Winter	600	\$0.1148	\$0.1053	\$0.1064	\$0.1043	\$0.1075	\$0.1107	\$0.1140	\$0.1174	\$0.1209	\$0.1256	\$0.1305	
1/2/2009	9	Semi	Winter	600	\$0.1267	\$0.1162	\$0.1174	\$0.1151	\$0.1186	\$0.1221	\$0.1258	\$0.1296	\$0.1335	\$0.1386	\$0.1440	
1/2/2009	10	Semi	Winter	600	\$0.1267	\$0.1162	\$0.1174	\$0.1151	\$0.1186	\$0.1221	\$0.1258	\$0.1296	\$0.1335	\$0.1386	\$0.1440	

Figure 7-12 shows the definition page for the Rate workbook. This worksheet was developed for each rate defined for the system. The most current rate sheets from each utility were obtained to develop the electric rates used in the system. The calculated values in the upper part of the

workbook are used to prepare the data in the Calculation workbook in Figure 7-11. Please note, however, that in the individual electric rate workbooks the link between this page and the calculation page has been broken in an effort to increase the calculation speed of the system. The original workbook with the links intact is also available if the rates need to be redefined.

Figure 7-12: Electric Rate Definition Worksheet

Demand	2007	2008	2009	2010	2011	2012	2013	2014	2015	2016	2017	2018	2019
DemSummerOn	\$0.00	\$0.00	\$0.00	\$0.00	\$0.00	\$0.00	\$0.00	\$0.00	\$0.00	\$0.00	\$0.00	\$0.00	\$0.00
DemSummerSemi	\$0.00	\$0.00	\$0.00	\$0.00	\$0.00	\$0.00	\$0.00	\$0.00	\$0.00	\$0.00	\$0.00	\$0.00	\$0.00
DemSummerOff	\$0.00	\$0.00	\$0.00	\$0.00	\$0.00	\$0.00	\$0.00	\$0.00	\$0.00	\$0.00	\$0.00	\$0.00	\$0.00
DemSummerMax	\$11.06	\$10.56	\$11.10	\$11.32	\$11.66	\$12.01	\$12.37	\$12.74	\$13.12	\$13.63	\$14.16	\$14.71	\$15.28
DemWinterOn	\$0.00	\$0.00	\$0.00	\$0.00	\$0.00	\$0.00	\$0.00	\$0.00	\$0.00	\$0.00	\$0.00	\$0.00	\$0.00
DemWinterSemi	\$0.00	\$0.00	\$0.00	\$0.00	\$0.00	\$0.00	\$0.00	\$0.00	\$0.00	\$0.00	\$0.00	\$0.00	\$0.00
DemWinterOff	\$0.00	\$0.00	\$0.00	\$0.00	\$0.00	\$0.00	\$0.00	\$0.00	\$0.00	\$0.00	\$0.00	\$0.00	\$0.00
DemWinterMax	\$6.75	\$6.44	\$6.77	\$6.91	\$7.12	\$7.33	\$7.55	\$7.78	\$8.01	\$8.32	\$8.64	\$8.98	\$9.33
Energy	2007	2008	2009	2010	2011	2012	2013	2014	2015	2016	2017	2018	2019
ElecSummerOn	\$0.1830	\$0.1679	\$0.1696	\$0.1663	\$0.1713	\$0.1764	\$0.1817	\$0.1872	\$0.1928	\$0.2002	\$0.2080	\$0.2160	\$0.2244
ElecSummerSemi	\$0.1581	\$0.1451	\$0.1466	\$0.1437	\$0.1480	\$0.1525	\$0.1570	\$0.1617	\$0.1666	\$0.1730	\$0.1797	\$0.1867	\$0.1939
ElecSummerOff	\$0.1434	\$0.1315	\$0.1329	\$0.1303	\$0.1342	\$0.1382	\$0.1423	\$0.1466	\$0.1510	\$0.1569	\$0.1629	\$0.1692	\$0.1758
ElecWinterOn	\$0.0000	\$0.0000	\$0.0000	\$0.0000	\$0.0000	\$0.0000	\$0.0000	\$0.0000	\$0.0000	\$0.0000	\$0.0000	\$0.0000	\$0.0000
ElecWinterSemi	\$0.1267	\$0.1162	\$0.1174	\$0.1151	\$0.1186	\$0.1221	\$0.1258	\$0.1296	\$0.1335	\$0.1386	\$0.1440	\$0.1496	\$0.1554
ElecWinterOff	\$0.1148	\$0.1053	\$0.1064	\$0.1043	\$0.1075	\$0.1107	\$0.1140	\$0.1174	\$0.1209	\$0.1256	\$0.1305	\$0.1356	\$0.1408
From CEC CED F Commercial	13.63	12.75	13.14	13.14	13.27	13.40	13.53	13.67	13.80	14.05	14.31	14.57	14.84
Economic Data/Fuel Price Data/California Ac	6.9%	-3.0%	0.0%		1.0%	1.0%	1.0%	1.0%	1.0%	1.8%	1.8%	1.8%	1.8%
Inflation	0.02	0.02	0.02	0.02	0.02	0.02	0.02	0.02	0.02	0.02	0.02	0.02	0.02
PG&E	Schedule A10 - TOU < 500 kW												
	Demand Charges (\$/kW)			Seasonal									
	Secondary Non-Coincident	\$0.00		Summer		May 01, 2009		Oct 31, 2009					
	Max summer	\$11.3200		Winter		Nov 01, 2009		Apr 30, 2009					
	Max winter	\$6.9100											
	Power factor	\$0.0000											
	Energy Charges												
	Summer												
		Total		Total	TimeStart1	TimeEnd1	TimeStart2	TimeEnd2				12:00:00 AM	1:00:00 AM
On	On-Peak (\$/kWh)	\$0.16628		\$0.1663	12:00:00 PM	5:59:59 PM			6	-			
Semi	Semi-Peak	\$0.14370		\$0.1437	8:30:00 AM	11:59:59 AM	6:00:00 PM	9:29:59 PM	3	3			
Off	Off-Peak	\$0.13026		\$0.1303	12:00:00 AM	8:29:59 AM	9:30:00 PM	11:59:59 PM	8	2	Off	Off	Off
									24	Summer			
	Winter												
On	On-Peak			\$0.0000					-	-			
Semi	Semi-Peak	\$0.11512		\$0.1151	8:30:00 AM	9:29:59 PM			13				
Off	Off-Peak	\$0.10433		\$0.1043	12:00:00 AM	8:29:59 AM	9:30:00 PM	11:59:59 PM	8	2	Off	Off	Off

Non-Residential Gas Rates

The Gas Transportation workbook is a workbook obtained from E3 to get gas rates paid by consumers for the runs. The workbook takes values from the inputs for each line item being run and supplies them to this workbook. The calculated values for gas rates are then copied from the Gas Transportation workbook and used in the calculations for the current technology. Figure 7-14, Figure 7-15, Figure 7-16, and Figure 7-17 show snippets of the gas transportation workbook for review. The workbook is found in the Inputs directory.

Figure 7-13: Gas Transportation Summary Worksheet

Increased Revenue from fuel transportation for gas-fired DG								
IOU	PG&E							
Generator Size (kW)	4	c11	From tech inputs					
Capacity Factor	20%	c19	Calculated from tech inputs					
Gross Heat Rate (Btu in / kWh)	-	0	Calculated from tech inputs (3412/elec eff % from tech)					
Power / Heat Ratio	1.05		Constant					
CHP Lifetime	20	c22	From tech inputs					
Replaced Boiler Efficiency	80%		Constant					
Non-CHP gas use (therms/year)	100,000		What is the gas use of the site after installing the CHP for non-CHP technologies.					
Participant Discount Rate	9%	as36	Need to set to the same as the calc engine					
Utility Discount Rate	8.65%	at36	Need to set to the same as the calc engine					
Inflation	2%	m31	Using the first value in the series					
Useful Waste Heat (Btu out per kW)	-	tech						
Lifecycle Value of Gas Rate Changes (NPV \$/kW)				Lifecycle Value of Gas Rate (NPV \$)				
Installation Year	PG&E		SDG&E		SoCal Gas		PG&E	
	Participant	Utility	Participant	Utility	Participant	Utility	Participant	Utility
2008	0	0	0	0	0	0	-	-
2009	0	0	0	0	0	0	-	-

Figure 7-14: Gas Transportation CalcsSeparate Worksheet

Increased Revenue from fuel transportation for gas-fired DG (negative number indicates a decrease in revenue)							
Generator Size (kW)	4					Pre-CHP (therms/month)	
Capacity Factor	20%					Boiler Usage	
Gross Heat Rate (Btu/kWh)	-					Other Gas Use	
Power / Heat Ratio	1.05					Total Gas Use	
CHP Lifetime	20					8,333	
Replaced Boiler Efficiency	80%						
Non-CHP gas use (therms/year)	100,000	Note: Make changes to inputs on Summary tab					
	kWh	therms	btus				
Gas Input (annual)				Check			
Electric output (annual)	1,446	49	4,934,907				
Thermal output (annual)	1,377			Check			
				#DIV/0!		Total Efficiency Level	
PG&E							
Lifecycle Value of Gas Rate Changes				Pre-CHP Costs			
(NPV \$)				(NPV \$)			
Installation Year	Participant	Utility		Installation Year	Participant	Utility	
2008	-	-		2008	173,014	(177,211)	
2009	-	-		2009	177,196	(181,479)	
2010	-	-		2010	181,262	(185,630)	
2011	-	-		2011	184,887	(189,343)	

Figure 7-15: Gas Transportation UseinCECalcEng Worksheet

Years	Transportation Savings	Increase in Bill for CHP Generation	Decrease in Bill for CHP Boiler Savings
2008	\$0	\$0	\$0
2009	\$0	\$0	\$0
2010	\$0	\$0	\$0
2011	\$0	\$0	\$0
2012	\$0	\$0	\$0
2013	\$0	\$0	\$0
2014	\$0	\$0	\$0
2015	\$0	\$0	\$0
2016	\$0	\$0	\$0
2017	\$0	\$0	\$0
2018	\$0	\$0	\$0
2019	\$0	\$0	\$0
2020	\$0	\$0	\$0
2021	\$0	\$0	\$0
2022	\$0	\$0	\$0
2023	\$0	\$0	\$0
2024	\$0	\$0	\$0
2025	\$0	\$0	\$0
2026	\$0	\$0	\$0
2027	\$0	\$0	\$0
2028	\$0	\$0	\$0
2029	\$0	\$0	\$0
2030	\$0	\$0	\$0
2031	\$0	\$0	\$0
2032	\$0	\$0	\$0
2033	\$0	\$0	\$0
2034	\$0	\$0	\$0
2035	\$0	\$0	\$0
2036	\$0	\$0	\$0
2037	\$0	\$0	\$0
2038	\$0	\$0	\$0

Figure 7-16: Gas Transportation Utility Rate Definition Example

GN-T (non-core)								
\$/therm								
		Distribution						
		Tier 1		Tier 2		Tier 3		
		0-20,833 therms		20,834-49,999 therms		50,000-166,666 therms		
	Backbone	Transmission	Summer	Winter	Summer	Winter	Summer	Winter
2008	\$0.00343	\$0.02152	\$0.12835	\$0.16798	\$0.08804	\$0.11356	\$0.08171	\$0.10501
2009	\$0.00232	\$0.02217	\$0.13332	\$0.17382	\$0.09212	\$0.11820	\$0.08565	\$0.10946
2010	\$0.00514	\$0.02574	\$0.14117	\$0.18256	\$0.09907	\$0.12572	\$0.09245	\$0.11679
2011	\$0.00524	\$0.02625	\$0.14399	\$0.18621	\$0.10105	\$0.12823	\$0.09430	\$0.11913
2012	\$0.00535	\$0.02678	\$0.14687	\$0.18994	\$0.10307	\$0.13080	\$0.09618	\$0.12151
2013	\$0.00545	\$0.02732	\$0.14981	\$0.19373	\$0.10513	\$0.13342	\$0.09811	\$0.12394
2014	\$0.00556	\$0.02786	\$0.15281	\$0.19761	\$0.10724	\$0.13608	\$0.10007	\$0.12642
2015	\$0.00567	\$0.02842	\$0.15586	\$0.20156	\$0.10938	\$0.13881	\$0.10207	\$0.12895
2016	\$0.00579	\$0.02899	\$0.15898	\$0.20559	\$0.11157	\$0.14158	\$0.10411	\$0.13152
2017	\$0.00590	\$0.02957	\$0.16216	\$0.20970	\$0.11380	\$0.14441	\$0.10620	\$0.13415
2018	\$0.00602	\$0.03016	\$0.16540	\$0.21390	\$0.11608	\$0.14730	\$0.10832	\$0.13684
2019	\$0.00614	\$0.03076	\$0.16871	\$0.21818	\$0.11840	\$0.15025	\$0.11049	\$0.13957
2020	\$0.00627	\$0.03138	\$0.17209	\$0.22254	\$0.12077	\$0.15325	\$0.11270	\$0.14237
2021	\$0.00639	\$0.03200	\$0.17553	\$0.22699	\$0.12318	\$0.15632	\$0.11495	\$0.14521
2022	\$0.00652	\$0.03264	\$0.17904	\$0.23153	\$0.12564	\$0.15944	\$0.11725	\$0.14812
2023	\$0.00665	\$0.03330	\$0.18262	\$0.23616	\$0.12816	\$0.16263	\$0.11959	\$0.15108
2024	\$0.00678	\$0.03396	\$0.18627	\$0.24088	\$0.13072	\$0.16588	\$0.12199	\$0.15410
2025	\$0.00692	\$0.03464	\$0.19000	\$0.24570	\$0.13334	\$0.16920	\$0.12443	\$0.15718
2026	\$0.00706	\$0.03534	\$0.19380	\$0.25062	\$0.13600	\$0.17259	\$0.12691	\$0.16033
2027	\$0.00720	\$0.03604	\$0.19767	\$0.25563	\$0.13872	\$0.17604	\$0.12945	\$0.16353
2028	\$0.00734	\$0.03676	\$0.20163	\$0.26074	\$0.14150	\$0.17956	\$0.13204	\$0.16680
2029	\$0.00749	\$0.03750	\$0.20566	\$0.26596	\$0.14433	\$0.18315	\$0.13468	\$0.17014
2030	\$0.00764	\$0.03825	\$0.20977	\$0.27127	\$0.14721	\$0.18681	\$0.13738	\$0.17354
2031	\$0.00779	\$0.03901	\$0.21397	\$0.27670	\$0.15016	\$0.19055	\$0.14012	\$0.17701
2032	\$0.00795	\$0.03979	\$0.21825	\$0.28223	\$0.15316	\$0.19436	\$0.14293	\$0.18055
2033	\$0.00811	\$0.04059	\$0.22261	\$0.28788	\$0.15622	\$0.19825	\$0.14578	\$0.18417
2034	\$0.00827	\$0.04140	\$0.22706	\$0.29364	\$0.15935	\$0.20221	\$0.14870	\$0.18785
2035	\$0.00843	\$0.04223	\$0.23160	\$0.29951	\$0.16253	\$0.20626	\$0.15167	\$0.19161
2036	\$0.00859	\$0.04307	\$0.23624	\$0.30550	\$0.16578	\$0.21040	\$0.15467	\$0.19544

Figure 7-17: Gas Transportation Fuel Prices Worksheet

Form 2.3 - CED 2009 Natural Gas Rates (per therms)										Form 2.3 - CED 2009 Electricity Prices (2007 cents/kWh)									
Year	Industrial (2005\$)			Commercial (2005\$)			Residential (1977\$)			Year	Industrial			Commercial			Residential		
	PG&E	SCG	SDG&E	PG&E	SCG	SDG&E	PG&E	SCG	SDG&E		PG&E	SCE	SDG&E	PG&E	SCE	SDG&E	PG&E	SCE	SDG&E
2010	1.11	0.98	0.72	1.11	0.98	0.54	0.38	0.36	0.37	2010	9.42	10.81	13.51	13.14	15.03	13.85	14.18	14.16	15.95
2011	1.12	0.99	0.73	1.12	0.99	0.55	0.39	0.36	0.37	2011	9.51	10.92	13.64	13.27	15.18	13.99	14.31	14.30	16.11
2012	1.13	1.00	0.73	1.13	1.00	0.55	0.39	0.37	0.37	2012	9.60	11.02	13.77	13.40	15.33	14.13	14.45	14.44	16.26
2013	1.14	1.01	0.74	1.14	1.01	0.56	0.39	0.37	0.38	2013	9.70	11.13	13.91	13.53	15.48	14.27	14.60	14.58	16.42
2014	1.15	1.02	0.75	1.15	1.02	0.56	0.40	0.37	0.38	2014	9.79	11.24	14.05	13.67	15.63	14.41	14.74	14.73	16.59
2015	1.16	1.02	0.75	1.16	1.02	0.57	0.40	0.38	0.38	2015	9.89	11.35	14.18	13.80	15.78	14.55	14.88	14.87	16.75
2016	1.17	1.03	0.76	1.17	1.03	0.57	0.41	0.38	0.39	2016	10.07	11.56	14.44	14.05	16.07	14.81	15.16	15.14	17.06
2017	1.18	1.04	0.77	1.18	1.04	0.58	0.41	0.38	0.39	2017	10.25	11.77	14.71	14.31	16.37	15.09	15.44	15.42	17.37
2018	1.20	1.05	0.78	1.20	1.05	0.58	0.41	0.39	0.40	2018	10.44	11.99	14.98	14.57	16.67	15.36	15.72	15.71	17.69
2019	1.21	1.07	0.78	1.21	1.07	0.59	0.42	0.39	0.40	2019	10.63	12.21	15.25	14.84	16.97	15.65	16.01	15.99	18.01
2020	1.22	1.08	0.79	1.22	1.08	0.60	0.42	0.40	0.40	2020	10.83	12.43	15.53	15.11	17.28	15.93	16.30	16.29	18.34

Source:
<http://www.energy.ca.gov/2009publications/CEC-200-2009-012/index.html>

Growth in real costs			
	0.009677495	0.01	0.01

Source:
<http://www.energy.ca.gov/2009publications/CEC-200-2009-012/index.html>
 Natural Gas Price Forecasts from EIA's Annual Energy Outlook 2010

Year	Henry Hub Spot Price		From CPUC MPR Worksheet		
	2008 dollars per million Btu	nominal dollars per million Btu	22-Day Ave. NYMEX Closing Prices (07/27/09 - 08/25/09)		
2008	8.86				
2009	3.49				
2010	4.50	4.64	5.89		
2011	5.68	5.93	6.73	0.262	0.142
2012	6.17	6.53	6.91	0.086	0.027
2013	6.13	6.60	7.02	-0.007	0.015
2014	6.09	6.67	7.15	-0.007	0.019
2015	6.27	6.99	7.30	0.03	0.021
2016	6.38	7.23	7.44	0.017	0.019
2017	6.38	7.38	7.59	0.001	0.02
2018	6.43	7.57	7.74	0.008	0.02
2019	6.51	7.80	7.89	0.011	0.019
2020	6.64	8.11	8.04	0.021	0.019

Source:
http://www.eia.doe.gov/oi/af/aeo/aeoref_tab.html

Year	Forecast (nominal \$/MMBtu)	Annual Average Natural Gas Forecast
		* Gas forecast from 2010 to 2040 based on 2009 MPR update

Residential Gas & Electric Rates

The residential rates for both gas and electric are stored in a single workbook. Figure 7-18 through Figure 7-21 show snippets of the worksheets that are used to calculate the electric rates and Figure 7-22 and Figure 7-23 are examples of the worksheets used to calculate the gas rates used by the system.

Figure 7-18 shows the residential rate calculation page where the system retrieves the calculated rate for the technology being simulated. In this figure the worksheet is setup to calculate a Time-of-Use (TOU) rate. The upper table of calculated values is used in this case to be multiplied by the monthly production of the technology to calculate the annual energy rate for the system to retrieve and supply to the Calc Engine.

Figure 7-19 shows the same worksheet setup to calculate a Tiered rate for a residential technology. Here the lower table of calculated values is used to calculate the annual energy rate

used by the system for the calculations. The choice of appropriate tier was estimated using usage data from residential sites participating the California Solar Initiative.

Figure 7-18: Electric TOU Rate Calculation Example

Utility	PGE																
Rate	TOUD1																
Base	TOU																
Region	Coast		Wtd Ave Utility Rate Do not format cells with this fill color														
			2007	2008	2009	2010	2011	2012	2013	2014	2015	2016	2017	2018	2019		
			0	0	0	0	0	0	0	0	0	0	0	0	0	0	0
TOU			Weights														
	ElecSummerOn	-	\$0.5392	\$0.5176	\$0.5386	\$0.5493	\$0.5658	\$0.5828	\$0.6003	\$0.6183	\$0.6368	\$0.6615	\$0.6871	\$0.7137	\$0.7414		
	ElecSummerSemi	-	\$0.0000	\$0.0000	\$0.0000	\$0.0000	\$0.0000	\$0.0000	\$0.0000	\$0.0000	\$0.0000	\$0.0000	\$0.0000	\$0.0000	\$0.0000		
	ElecSummerOff	-	\$0.2386	\$0.2290	\$0.2383	\$0.2430	\$0.2503	\$0.2578	\$0.2656	\$0.2735	\$0.2817	\$0.2927	\$0.3040	\$0.3158	\$0.3280		
	ElecWinterOn	-	\$0.2524	\$0.2422	\$0.2521	\$0.2571	\$0.2648	\$0.2728	\$0.2809	\$0.2894	\$0.2981	\$0.3096	\$0.3216	\$0.3340	\$0.3470		
	ElecWinterSemi	-	\$0.0000	\$0.0000	\$0.0000	\$0.0000	\$0.0000	\$0.0000	\$0.0000	\$0.0000	\$0.0000	\$0.0000	\$0.0000	\$0.0000	\$0.0000		
	ElecWinterOff	-	\$0.2186	\$0.2098	\$0.2183	\$0.2227	\$0.2294	\$0.2362	\$0.2433	\$0.2506	\$0.2581	\$0.2681	\$0.2785	\$0.2893	\$0.3005		
Tier																	
Summer																	
Summer	Baseline	#N/A	#N/A	#N/A	#N/A	#N/A	#N/A	#N/A	#N/A	#N/A	#N/A	#N/A	#N/A	#N/A	#N/A	#N/A	#N/A
Summer	2nd Tier	#N/A	#N/A	#N/A	#N/A	#N/A	#N/A	#N/A	#N/A	#N/A	#N/A	#N/A	#N/A	#N/A	#N/A	#N/A	#N/A
Summer	3rd Tier	#N/A	#N/A	#N/A	#N/A	#N/A	#N/A	#N/A	#N/A	#N/A	#N/A	#N/A	#N/A	#N/A	#N/A	#N/A	#N/A
Summer	4th Tier	#N/A	#N/A	#N/A	#N/A	#N/A	#N/A	#N/A	#N/A	#N/A	#N/A	#N/A	#N/A	#N/A	#N/A	#N/A	#N/A
Summer	5th Tier	#N/A	#N/A	#N/A	#N/A	#N/A	#N/A	#N/A	#N/A	#N/A	#N/A	#N/A	#N/A	#N/A	#N/A	#N/A	#N/A
Summer	Sold Back?	-	#N/A	#N/A	#N/A	#N/A	#N/A	#N/A	#N/A	#N/A	#N/A	#N/A	#N/A	#N/A	#N/A	#N/A	#N/A
Winter																	
Winter	Baseline	#N/A	#N/A	#N/A	#N/A	#N/A	#N/A	#N/A	#N/A	#N/A	#N/A	#N/A	#N/A	#N/A	#N/A	#N/A	#N/A
Winter	2nd Tier	#N/A	#N/A	#N/A	#N/A	#N/A	#N/A	#N/A	#N/A	#N/A	#N/A	#N/A	#N/A	#N/A	#N/A	#N/A	#N/A
Winter	3rd Tier	#N/A	#N/A	#N/A	#N/A	#N/A	#N/A	#N/A	#N/A	#N/A	#N/A	#N/A	#N/A	#N/A	#N/A	#N/A	#N/A
Winter	4th Tier	#N/A	#N/A	#N/A	#N/A	#N/A	#N/A	#N/A	#N/A	#N/A	#N/A	#N/A	#N/A	#N/A	#N/A	#N/A	#N/A
Winter	5th Tier	#N/A	#N/A	#N/A	#N/A	#N/A	#N/A	#N/A	#N/A	#N/A	#N/A	#N/A	#N/A	#N/A	#N/A	#N/A	#N/A
Winter	Sold Back?	-	#N/A	#N/A	#N/A	#N/A	#N/A	#N/A	#N/A	#N/A	#N/A	#N/A	#N/A	#N/A	#N/A	#N/A	#N/A

Figure 7-19: Electric Tiered Rate Calculation Example

Utility	PGE																
Rate	E1																
Base	Tier																
Region	Coast		Wtd Ave Utility Rate Do not format cells with this fill color														
			2007	2008	2009	2010	2011	2012	2013	2014	2015	2016	2017	2018	2019		
			0	0	0	0	0	0	0	0	0	0	0	0	0	0	0
TOU			Weights														
	ElecSummerOn	-	#N/A	#N/A	#N/A	#N/A	#N/A	#N/A	#N/A	#N/A	#N/A	#N/A	#N/A	#N/A	#N/A	#N/A	#N/A
	ElecSummerSemi	-	#N/A	#N/A	#N/A	#N/A	#N/A	#N/A	#N/A	#N/A	#N/A	#N/A	#N/A	#N/A	#N/A	#N/A	#N/A
	ElecSummerOff	-	#N/A	#N/A	#N/A	#N/A	#N/A	#N/A	#N/A	#N/A	#N/A	#N/A	#N/A	#N/A	#N/A	#N/A	#N/A
	ElecWinterOn	-	#N/A	#N/A	#N/A	#N/A	#N/A	#N/A	#N/A	#N/A	#N/A	#N/A	#N/A	#N/A	#N/A	#N/A	#N/A
	ElecWinterSemi	-	#N/A	#N/A	#N/A	#N/A	#N/A	#N/A	#N/A	#N/A	#N/A	#N/A	#N/A	#N/A	#N/A	#N/A	#N/A
	ElecWinterOff	-	#N/A	#N/A	#N/A	#N/A	#N/A	#N/A	#N/A	#N/A	#N/A	#N/A	#N/A	#N/A	#N/A	#N/A	#N/A
Tier																	
Summer																	
Summer	Baseline	-	\$0.1166	\$0.1119	\$0.1164	\$0.1188	\$0.1223	\$0.1260	\$0.1298	\$0.1337	\$0.1377	\$0.1430	\$0.1486	\$0.1543	\$0.1603		
Summer	2nd Tier	-	\$0.1325	\$0.1272	\$0.1324	\$0.1350	\$0.1391	\$0.1432	\$0.1475	\$0.1520	\$0.1565	\$0.1626	\$0.1689	\$0.1754	\$0.1822		
Summer	3rd Tier	-	\$0.2853	\$0.2738	\$0.2849	\$0.2906	\$0.2993	\$0.3083	\$0.3176	\$0.3271	\$0.3369	\$0.3500	\$0.3635	\$0.3776	\$0.3922		
Summer	4th Tier	-	\$0.3929	\$0.3772	\$0.3924	\$0.4003	\$0.4123	\$0.4247	\$0.4374	\$0.4505	\$0.4641	\$0.4820	\$0.5007	\$0.5201	\$0.5402		
Summer	5th Tier	-	\$0.3929	\$0.3772	\$0.3924	\$0.4003	\$0.4123	\$0.4247	\$0.4374	\$0.4505	\$0.4641	\$0.4820	\$0.5007	\$0.5201	\$0.5402		
Summer	Sold Back?	-	\$0.0933	\$0.0895	\$0.0932	\$0.0950	\$0.0979	\$0.1008	\$0.1038	\$0.1069	\$0.1102	\$0.1144	\$0.1188	\$0.1235	\$0.1282		
Winter																	
Winter	Baseline	-	\$0.1166	\$0.1119	\$0.1164	\$0.1188	\$0.1223	\$0.1260	\$0.1298	\$0.1337	\$0.1377	\$0.1430	\$0.1486	\$0.1543	\$0.1603		
Winter	2nd Tier	-	\$0.1325	\$0.1272	\$0.1324	\$0.1350	\$0.1391	\$0.1432	\$0.1475	\$0.1520	\$0.1565	\$0.1626	\$0.1689	\$0.1754	\$0.1822		
Winter	3rd Tier	-	\$0.2853	\$0.2738	\$0.2849	\$0.2906	\$0.2993	\$0.3083	\$0.3176	\$0.3271	\$0.3369	\$0.3500	\$0.3635	\$0.3776	\$0.3922		
Winter	4th Tier	-	\$0.3929	\$0.3772	\$0.3924	\$0.4003	\$0.4123	\$0.4247	\$0.4374	\$0.4505	\$0.4641	\$0.4820	\$0.5007	\$0.5201	\$0.5402		
Winter	5th Tier	-	\$0.3929	\$0.3772	\$0.3924	\$0.4003	\$0.4123	\$0.4247	\$0.4374	\$0.4505	\$0.4641	\$0.4820	\$0.5007	\$0.5201	\$0.5402		
Winter	Sold Back?	-	\$0.0933	\$0.0895	\$0.0932	\$0.0950	\$0.0979	\$0.1008	\$0.1038	\$0.1069	\$0.1102	\$0.1144	\$0.1188	\$0.1235	\$0.1282		

The fields in the upper left corner in both figures above are populated by the system before any values are retrieved. The system sets the utility and rate and climate region associated with the technology being run. These data are used in the formulas to retrieve the proper inputs from the definition worksheets based on the values supplied. The workbook is then recalculated to update the data before copying the values in the stream of numbers labeled “Wtd Ave Utility Rate”.

Figure 7-21: Electric Rate Definition

	2007	2008	2009	2010	2011	2012	2013	2014	2015	2016	2017	2018	2019
PGE													
ElecSummerOn	\$0.5392	\$0.5176	\$0.5386	\$0.5493	\$0.5658	\$0.5828	\$0.6003	\$0.6183	\$0.6368	\$0.6615	\$0.6871	\$0.7137	\$0.7414
ElecSummerSemi	\$0.0000	\$0.0000	\$0.0000	\$0.0000	\$0.0000	\$0.0000	\$0.0000	\$0.0000	\$0.0000	\$0.0000	\$0.0000	\$0.0000	\$0.0000
ElecSummerOff	\$0.2386	\$0.2290	\$0.2383	\$0.2430	\$0.2503	\$0.2578	\$0.2656	\$0.2735	\$0.2817	\$0.2927	\$0.3040	\$0.3158	\$0.3280
ElecWinterOn	\$0.2524	\$0.2422	\$0.2521	\$0.2571	\$0.2648	\$0.2728	\$0.2809	\$0.2894	\$0.2981	\$0.3096	\$0.3216	\$0.3340	\$0.3470
ElecWinterSemi	\$0.0000	\$0.0000	\$0.0000	\$0.0000	\$0.0000	\$0.0000	\$0.0000	\$0.0000	\$0.0000	\$0.0000	\$0.0000	\$0.0000	\$0.0000
ElecWinterOff	\$0.2186	\$0.2098	\$0.2183	\$0.2227	\$0.2294	\$0.2362	\$0.2433	\$0.2506	\$0.2581	\$0.2681	\$0.2785	\$0.2893	\$0.3005
MultSummerOn	6.3%	-2.0%	0.0%	0.0%	1.0%	1.0%	1.0%	1.0%	1.0%	1.8%	1.8%	1.8%	1.8%
MultSummerSemi	6.3%	-2.0%	0.0%	0.0%	1.0%	1.0%	1.0%	1.0%	1.0%	1.8%	1.8%	1.8%	1.8%
MultSummerOff	6.3%	-2.0%	0.0%	0.0%	1.0%	1.0%	1.0%	1.0%	1.0%	1.8%	1.8%	1.8%	1.8%
MultWinterOn	6.3%	-2.0%	0.0%	0.0%	1.0%	1.0%	1.0%	1.0%	1.0%	1.8%	1.8%	1.8%	1.8%
MultWinterSemi	6.3%	-2.0%	0.0%	0.0%	1.0%	1.0%	1.0%	1.0%	1.0%	1.8%	1.8%	1.8%	1.8%
MultWinterOff	6.3%	-2.0%	0.0%	0.0%	1.0%	1.0%	1.0%	1.0%	1.0%	1.8%	1.8%	1.8%	1.8%
Inflation	2.0%	2.0%	2.0%	2.0%	2.0%	2.0%	2.0%	2.0%	2.0%	2.0%	2.0%	2.0%	2.0%
PGE Schedule TOU-D-1													
Demand Charges (\$/kW)													
this is a copy of SCE TOU rate without tiers.													
Seasonal													
Summer Jun 01, 2009 Sep 30, 2009													
Winter Oct 01, 2009 May 31, 2009													
Energy Charges													
Summer													
On-Peak (\$/kWh) Total URG DWR Total TimeStart1 TimeEnd1 TimeStart2 TimeEnd2													
Off-Peak \$0.0928 \$0.4190 \$0.0376 \$0.5493 10:00:00 AM 5:59:59 PM 8 - - 12:00:00 AM 1:00:00 AM													
Off-Peak \$0.0928 \$0.1127 \$0.0376 \$0.2430 12:00:00 AM 9:59:59 AM 6:00:00 PM 11:59:59 PM 10 6 Off Off													
24 Summer Off Off													
Winter													
On-Peak \$0.0928 \$0.1267 \$0.0376 \$0.2571 10:00:00 AM 5:59:59 PM 8 - -													
Off-Peak \$0.0928 \$0.0923 \$0.0376 \$0.2227 12:00:00 AM 9:59:59 AM 6:00:00 PM 11:59:59 PM 10 6 Off Off													
24 Winter Off Off													

The gas rate calculator worksheet, shown in Figure 7-22, is set up in a similar manner to all the other rates worksheets. In this case the monthly production curve lives on the Calculator worksheet. The fields in the upper left corner are lookup functions that reference the data supplied by the system about the utility specified and since there is only one gas rate per utility the gas rate name is looked up using the utility name. The system supplied the monthly production and then the workbook is recalculated. The line labeled “Value of Gas Required” is then copied and pasted into the Calc Engine workbook for use in the calculation.

Figure 7-22: Gas Rate Calculation Worksheet

Utility	PGE																
Rate	G1																
Value of Gas Required Do not format cells with this fill color																	
			2007	2008	2009	2010	2011	2012	2013	2014	2015	2016	2017	2018	2019		
			0	0	0	0	0	0	0	0	0	0	0	0	0		
Winter	Jan	-	\$1.3047	\$1.7265	\$1.2755	\$1.3010	\$1.3398	\$1.3798	\$1.4211	\$1.4635	\$1.5072	\$1.5522	\$1.5986	\$1.6464	\$1.6955		
Winter	Feb	-	\$1.3047	\$1.7265	\$1.2755	\$1.3010	\$1.3398	\$1.3798	\$1.4211	\$1.4635	\$1.5072	\$1.5522	\$1.5986	\$1.6464	\$1.6955		
Winter	Mar	-	\$1.3047	\$1.7265	\$1.2755	\$1.3010	\$1.3398	\$1.3798	\$1.4211	\$1.4635	\$1.5072	\$1.5522	\$1.5986	\$1.6464	\$1.6955		
Summer	Apr	-	\$1.3047	\$1.7265	\$1.2755	\$1.3010	\$1.3398	\$1.3798	\$1.4211	\$1.4635	\$1.5072	\$1.5522	\$1.5986	\$1.6464	\$1.6955		
Summer	May	-	\$1.3047	\$1.7265	\$1.2755	\$1.3010	\$1.3398	\$1.3798	\$1.4211	\$1.4635	\$1.5072	\$1.5522	\$1.5986	\$1.6464	\$1.6955		
Summer	Jun	-	\$1.3047	\$1.7265	\$1.2755	\$1.3010	\$1.3398	\$1.3798	\$1.4211	\$1.4635	\$1.5072	\$1.5522	\$1.5986	\$1.6464	\$1.6955		
Summer	Jul	-	\$1.3047	\$1.7265	\$1.2755	\$1.3010	\$1.3398	\$1.3798	\$1.4211	\$1.4635	\$1.5072	\$1.5522	\$1.5986	\$1.6464	\$1.6955		
Summer	Aug	-	\$1.3047	\$1.7265	\$1.2755	\$1.3010	\$1.3398	\$1.3798	\$1.4211	\$1.4635	\$1.5072	\$1.5522	\$1.5986	\$1.6464	\$1.6955		
Summer	Sep	-	\$1.3047	\$1.7265	\$1.2755	\$1.3010	\$1.3398	\$1.3798	\$1.4211	\$1.4635	\$1.5072	\$1.5522	\$1.5986	\$1.6464	\$1.6955		
Summer	Oct	-	\$1.3047	\$1.7265	\$1.2755	\$1.3010	\$1.3398	\$1.3798	\$1.4211	\$1.4635	\$1.5072	\$1.5522	\$1.5986	\$1.6464	\$1.6955		
Winter	Nov	-	\$1.3047	\$1.7265	\$1.2755	\$1.3010	\$1.3398	\$1.3798	\$1.4211	\$1.4635	\$1.5072	\$1.5522	\$1.5986	\$1.6464	\$1.6955		
Winter	Dec	-	\$1.3047	\$1.7265	\$1.2755	\$1.3010	\$1.3398	\$1.3798	\$1.4211	\$1.4635	\$1.5072	\$1.5522	\$1.5986	\$1.6464	\$1.6955		

As with all the other rate definitions the gas rates used by the system are defined by the most recent rate tariff sheets for each of the utilities. Figure 7-23 shows an example of this worksheet.

8

Results Workbooks

8.1 Overview

The Results workbook contains the output from all technologies run during a batch run. The workbook is comprised of numerous worksheets holding all the data from the runs. This section of the user guide will go through and present examples of each of the worksheets and give a brief explanation of their contents and how they relate to each other and how they relate to the Calc Engine.

This workbook is populated with results as the system runs through the list of technologies marked by the user for analysis. The output found on the Results tab in the Calc Engine is copied to a worksheet in the Results workbook that is specifically designated for that technology. This worksheet can be identified by its tab name, which exactly coordinates with the technology and its combination of settings. The same name is used to save the copy of the Calc Engine workbook if the user has specified that option. The worksheet holding the data is created from a template worksheet found in the Results workbook and is referred to by the other sheets found in the workbook.

8.2 Results Worksheets

The section will itemize the worksheets found in the workbook and explain their relationship to each other.

8.2.1 Summary and Input Worksheets

The Results workbook is divided into two basic types of worksheets. This section describes the initial worksheets that are stored in a template workbook that the system uses to start collecting the data from a batch run. These worksheets hold templates for storing information about the batch run, adoptions for all technology combinations, a summary sheet by technology, a summary sheet for aggregating results, and a template used to create the technology level worksheets. The first four worksheets will be described in this section. The last worksheet will be discussed in the next section.

8.2.2 Technology Worksheets

As mentioned above, there is a template workbook that is used by the system to create the results workbook(s) for the run. The results template can be found in the Results folder and is named *Results_Template.xlsx*. Depending on how the user specifies the run, the system may generate one results workbook or it may generate one results workbook for each utility represented in the technology batch list. Each of the workbooks has their beginning as a copy of *Results_Template.xlsx*.

Cover Tab

The Cover tab, shown in Figure 8-1, is used for documentation purposes for the user. It documents the basic information about the batch run that is specific to all the technologies in the run. Included is the Program Scenario Name, the Version Description, and the Default Year chosen by the user at run time. The first two parameters are used to define the unique name for the results and the Calculation workbooks stored for the run. The default year is used in the Calculation workbook to define what year the workbook should default to when the run is complete. It serves no purpose in uniquely defining the run.

Figure 8-1: Cover Tab

SGIPce Program Results	
Global Assumptions	
Program Scenario Name	BaseCase
Version Description	Version1Release
Default Year	2010

Adoptions

The Adoptions tab, shown in Figure 8-2, is a complete list of all adoptions for all possible combinations of technology groups available to the user. This tab is identical to the tab with the same name in the Adoptions workbook described in the previous section. When the results workbook is created by the system at run time, this tab is repopulated with the latest values available in the Adoptions workbook. Once populated, the user could make changes to these values independent of the batch run to look at possible changes in outcomes from having different adoption assumptions. There is no physical link between the two Adoption workbooks, as with all the other workbooks used in the system. If scenarios are being run, however, it is advised that the user make copies of the original workbook so that they can get back to the original run if or when desired.

Figure 8-2: Adoptions Tab

Adoptions (MW)	per Unit	2007	2008	2009	2010	2011	2012	2013	2014	2015	2016	2017	2018	2019	2020	# Units
PVCoast_Res_NA_PGE_C	0.004	3.7	5.1	6.1	7.2	8.4	9.6	2.8	-	-	-	-	-	-	-	936
PVCoast_Res_NA_SCE_C	0.004	3.4	6.1	8.2	11.5	12.9	15.3	17.7	20.0	22.4	7.1	-	-	-	-	856
PVCoast_Res_NA_SDGE_C	0.004	0.9	1.7	4.1	5.4	7.0	3.1	0.0	0.0	0.0	0.0	0.0	0.0	0.0	0.0	233
PVInland_Res_NA_PGE_I	0.005	18.3	25.0	29.6	35.3	40.9	46.6	13.7	-	-	-	-	-	-	-	3,651
PVInland_Res_NA_SCE_I	0.005	3.9	6.8	9.2	13.0	14.6	17.3	20.0	22.7	25.4	8.1	-	-	-	-	775
PVInland_Res_NA_SDGE_I	0.005	1.6	2.8	6.9	9.1	11.7	5.2	0.0	0.0	0.0	0.0	0.0	0.0	0.0	0.0	313
WD10kW_Res_NA_PGE_C	0.010	-	-	-	0.1	0.1	0.1	0.1	0.1	0.1	0.1	0.1	0.1	0.2	0.2	0.2
WD10kW_Res_NA_PGE_I	0.010	-	-	-	0.1	0.1	0.1	0.1	0.1	0.1	0.1	0.1	0.1	0.2	0.2	0.2
WD10kW_Res_NA_SCE_C	0.010	-	-	-	0.0	0.0	0.0	0.0	0.1	0.1	0.1	0.1	0.1	0.1	0.1	0.1
WD10kW_Res_NA_SCE_I	0.010	-	-	-	0.1	0.1	0.1	0.1	0.1	0.1	0.1	0.2	0.2	0.2	0.2	0.3
WD10kW_Res_NA_SDGE_C	0.010	-	-	-	0.0	0.0	0.0	0.0	0.0	0.0	0.0	0.0	0.1	0.1	0.1	0.1
WD10kW_Res_NA_SDGE_I	0.010	-	-	-	0.1	0.1	0.1	0.1	0.1	0.1	0.2	0.2	0.2	0.2	0.3	0.3
FC5kW_Res_NG_PGE_C	0.005	-	0.1	0.1	0.1	0.1	0.1	0.1	0.1	0.1	0.1	0.1	0.1	0.2	0.2	0.2
FC5kW_Res_NG_PGE_I	0.005	-	0.1	0.1	0.1	0.1	0.1	0.1	0.1	0.1	0.1	0.1	0.1	0.2	0.2	0.2
FC5kW_Res_NG_SCE_C	0.005	-	0.1	0.1	0.1	0.1	0.1	0.1	0.1	0.1	0.1	0.1	0.1	0.2	0.2	0.2
FC5kW_Res_NG_SCE_I	0.005	-	0.1	0.1	0.1	0.1	0.1	0.1	0.1	0.1	0.1	0.1	0.1	0.2	0.2	0.2
FC5kW_Res_NG_SDGE_C	0.005	-	0.1	0.1	0.1	0.1	0.1	0.1	0.1	0.1	0.1	0.1	0.1	0.2	0.2	0.2
FC5kW_Res_NG_SDGE_I	0.005	-	0.1	0.1	0.1	0.1	0.1	0.1	0.1	0.1	0.1	0.1	0.1	0.2	0.2	0.2
Storage25kW_Res_NA_PGE_C	0.025	-	0.1	0.1	0.1	0.1	0.1	0.2	0.3	0.4	0.5	0.7	1.0	1.4	2.0	-
Storage25kW_Res_NA_PGE_I	0.025	-	0.1	0.1	0.1	0.1	0.1	0.2	0.3	0.4	0.5	0.7	1.0	1.4	2.0	-
Storage25kW_Res_NA_SCE_C	0.025	-	0.1	0.1	0.1	0.1	0.1	0.1	0.1	0.1	0.1	0.2	0.2	0.3	0.3	0.4
Storage25kW_Res_NA_SCE_I	0.025	-	0.1	0.1	0.1	0.1	0.1	0.1	0.1	0.1	0.1	0.2	0.2	0.3	0.3	0.4
Storage25kW_Res_NA_SDGE_C	0.025	-	0.1	0.1	0.1	0.1	0.1	0.1	0.1	0.1	0.1	0.2	0.2	0.3	0.3	0.4
Storage25kW_Res_NA_SDGE_I	0.025	-	0.1	0.1	0.1	0.1	0.1	0.1	0.1	0.1	0.1	0.2	0.2	0.3	0.3	0.4
PVCoast_GNP_NA_PGE_C	0.045	5.5	2.2	2.4	3.1	3.8	4.5	5.2	5.9	6.6	0.0	0.0	0.0	0.0	0.0	121
PVCoast_NR_NA_PGE_C	0.045	7.0	2.8	3.1	4.0	4.9	5.8	6.7	7.6	8.8	0.0	0.0	0.0	0.0	0.0	155
PVCoast_GNP_NA_SCE_C	0.045	15.1	0.1	5.6	8.3	9.7	11.1	12.6	14.0	15.4	16.9	0.0	0.0	0.0	0.0	396
PVCoast_NR_NA_SCE_C	0.045	32.6	0.2	12.1	17.8	20.9	24.0	27.0	30.1	33.2	36.3	0.0	0.0	0.0	0.0	724
PVCoast_GNP_NA_SDGE_C	0.045	3.5	1.4	3.1	4.0	5.0	6.1	0.3	0.0	0.0	0.0	0.0	0.0	0.0	0.0	78
PVCoast_NR_NA_SDGE_C	0.045	6.4	2.6	5.7	7.3	9.2	11.2	0.6	0.0	0.0	0.0	0.0	0.0	0.0	0.0	142
PVInland_GNP_NA_PGE_I	0.062	27.5	11.1	12.2	15.8	19.3	22.8	26.3	29.8	3.3	0.0	0.0	0.0	0.0	0.0	444
PVInland_NR_NA_PGE_I	0.062	44.0	17.8	19.4	25.2	30.8	36.4	42.0	47.6	5.2	0.0	0.0	0.0	0.0	0.0	710
PVInland_GNP_NA_SCE_I	0.062	7.0	0.0	2.6	3.8	4.5	5.2	5.8	6.5	7.2	7.8	0.0	0.0	0.0	0.0	113
PVInland_NR_NA_SCE_I	0.062	20.1	0.1	7.5	10.9	12.9	14.8	16.7	18.6	20.5	22.4	0.0	0.0	0.0	0.0	324
PVInland_GNP_NA_SDGE_I	0.062	3.0	1.2	2.6	3.4	4.3	5.1	0.3	0.0	0.0	0.0	0.0	0.0	0.0	0.0	48
PVInland_NR_NA_SDGE_I	0.062	5.2	2.1	4.5	5.9	7.4	9.0	0.5	0.0	0.0	0.0	0.0	0.0	0.0	0.0	83

Summary Statistics per Unit

The SummaryStats_perUnit tab, seen in Figure 8-3, holds the unit-level results for each technology combination saved to the Results workbook. The benefit and cost data from each run are presented in this worksheet for three user-defined years of the batch run. These results are later used to aggregate up to other levels, as will be displayed in the next tab. It should be noted that the List of Technologies is instrumental in the functioning of this workbook. That list tells the workbook what tabs it should expect to find in the workbook so that it can get the results for that technology group. As this is a very dynamic workbook, it is important that this list be preserved for proper use.

Three tests are represented on this tab: the Societal TRC test, the Participant Test, and the Program Administrator test. For each test the user can see the benefits and the costs and then the benefit/cost ratio calculated at the technology group level. If the technology group participated in a program then the rebates received are also available on this tab.

As mentioned above, the years presented in this table are user-defined. In Figure 8-3 there are three cells with a yellow background. The user may choose any three years chronologically from the set of results to use in these cells to see the results from those years. The years chosen by the user flow through to the summary of total results described in the next section as well.

Figure 8-3: Technology Level Summary Data

List of Technologies	MW per Unit	Total PA Rebates			TRC Ratios			PCT Ratios		
		2010	2016	2020	2010	2016	2020	2010	2016	2020
GTle2MW_NR_NG_PGE_I	1.00	\$0	\$0	\$0	88%	88%	86%	79%	85%	87%
GTle2MW_NR_OSBGas_PGE_I	1.00	\$0	\$0	\$0	89%	92%	92%	106%	117%	122%
GTle2MW_NR_DIRBGas_PGE_I	1.00	\$0	\$0	\$0	95%	95%	94%	74%	77%	78%
GTg2to5MW_NR_NG_PGE_I	3.50	\$0	\$0	\$0	109%	109%	108%	93%	101%	105%
GTg2to5MW_NR_OSBGas_PGE_I	3.50	\$0	\$0	\$0	117%	123%	124%	140%	159%	170%
GTg2to5MW_NR_DIRBGas_PGE_I	3.50	\$0	\$0	\$0	116%	116%	116%	85%	89%	91%
FC1200kW_NR_NG_PGE_I	1.20	\$0	\$0	\$0	104%	114%	115%	91%	103%	106%
FC1200kW_NR_OSBGas_PGE_I	1.20	\$0	\$0	\$0	101%	119%	124%	112%	134%	142%
FC1200kW_NR_DIRBGas_PGE_I	1.20	\$0	\$0	\$0	107%	118%	120%	97%	105%	106%
FC1200kWe_NR_NG_PGE_I	1.20	\$0	\$0	\$0	91%	101%	100%	86%	98%	98%
FC1200kWe_NR_OSBGas_PGE_I	1.20	\$0	\$0	\$0	87%	100%	101%	100%	119%	122%
FC1200kWe_NR_DIRBGas_PGE_I	1.20	\$0	\$0	\$0	93%	104%	104%	92%	101%	101%
MT200kW_NR_NG_PGE_I	0.20	\$0	\$0	\$0	105%	106%	105%	98%	102%	104%
MT200kW_NR_OSBGas_PGE_I	0.20	\$0	\$0	\$0	124%	152%	164%	82%	87%	86%
MT200kW_NR_DIRBGas_PGE_I	0.20	\$0	\$0	\$0	113%	114%	114%	87%	89%	89%
ICE500kW_NR_NG_PGE_I	0.50	\$0	\$0	\$0	121%	122%	121%	118%	125%	129%
ICE500kW_NR_OSBGas_PGE_I	0.50	\$0	\$0	\$0	182%	239%	269%	106%	118%	121%
ICE500kW_NR_DIRBGas_PGE_I	0.50	\$0	\$0	\$0	128%	129%	129%	102%	105%	107%
ICE1500kW_NR_NG_PGE_I	1.50	\$0	\$0	\$0	129%	129%	128%	107%	117%	122%
ICE1500kW_NR_OSBGas_PGE_I	1.50	\$0	\$0	\$0	151%	172%	180%	181%	233%	269%
ICE1500kW_NR_DIRBGas_PGE_I	1.50	\$0	\$0	\$0	136%	138%	137%	94%	99%	101%
ORC500kW_NR_NA_PGE_I	0.50	\$0	\$0	\$0	153%	172%	178%	122%	135%	138%
WD1MW_NR_NA_PGE_I	1.00	\$0	\$0	\$0	139%	170%	176%	162%	193%	199%
Storage1MW_NR_NA_PGE_I	1.00	\$0	\$0	\$0	57%	68%	75%	51%	57%	60%
Storage25kW_NR_NA_PGE_I	0.03	\$0	\$0	\$0	51%	60%	66%	46%	50%	53%

Summary Statistics, Totals

The SummaryStats_Totals worksheet aggregates the results found in the SummaryStats_perUnit workbook and calculates the benefit/cost ratios weighted by adoptions. The results of these calculations are presented numerically and graphically on this worksheet. Figure 8-4 shows the numerical calculations found on this worksheet. The user can find the technology group adoptions and the benefit and cost inputs in the lower section of the tab. In the upper part of the tab the user can find the adoption weighted benefits and costs as well as the calculation of the benefit/cost tests. These are all presented by overall technology, sector, and total.

Figure 8-4: Overall Summary Data

List of Technology Groups	Adoptions - MW			Total PA Rebates (\$000)			TRC Ratios			PCT R	
	2010	2016	2020	2010	2016	2020	2010	2016	2020	2010	2016
Totals	2.3	19.3	81.4	\$0	\$0	\$0	104%	112%	113%	96%	101%
Res	0.0	0.0	0.0	\$0	\$0	\$0	N/A	N/A	N/A	N/A	N/A
PV	0.0	0.0	0.0	\$0	\$0	\$0	N/A	N/A	N/A	N/A	N/A
Wind	0.0	0.0	0.0	\$0	\$0	\$0	N/A	N/A	N/A	N/A	N/A
Fuel Cell	0.0	0.0	0.0	\$0	\$0	\$0	N/A	N/A	N/A	N/A	N/A
Storage	0.0	0.0	0.0	\$0	\$0	\$0	N/A	N/A	N/A	N/A	N/A
NonRes	2.3	19.3	81.4	\$0	\$0	\$0	104%	112%	113%	96%	101%
PV	0.0	0.0	0.0	\$0	\$0	\$0	N/A	N/A	N/A	N/A	N/A
Wind	0.1	0.7	2.0	\$0	\$0	\$0	139%	170%	176%	162%	193%
Fuel Cell	1.0	3.3	8.3	\$0	\$0	\$0	97%	113%	116%	95%	109%
Storage	0.1	1.1	5.1	\$0	\$0	\$0	54%	64%	72%	48%	54%
ICE	0.3	3.7	18.5	\$0	\$0	\$0	128%	131%	131%	112%	120%
ORC Engine	0.0	0.1	0.2	\$0	\$0	\$0	153%	172%	178%	122%	135%
Micro Turbine	0.7	8.2	41.5	\$0	\$0	\$0	107%	111%	111%	95%	99%
Gas Turbine	0.0	2.3	5.9	\$0	\$0	\$0	N/A	96%	94%	N/A	91%

List of Technologies	MW per Unit	2010	2016	2020	2010	2016	2020	2010	2016	2020	2010	2016
GTle2MW_NR_NG_PGE_I	1.00	-	0.7	1.9	\$0	\$0	\$0	88%	88%	86%	79%	
GTle2MW_NR_OSBGas_PGE_I	1.00	-	0.5	1.4	\$0	\$0	\$0	89%	92%	92%	106%	1
GTle2MW_NR_DIRBGas_PGE_I	1.00	-	0.5	1.4	\$0	\$0	\$0	95%	95%	94%	74%	
GTg2to5MW_NR_NG_PGE_I	3.50	-	0.3	0.5	\$0	\$0	\$0	109%	109%	108%	93%	1
GTg2to5MW_NR_OSBGas_PGE_I	3.50	-	0.2	0.3	\$0	\$0	\$0	117%	123%	124%	140%	1
GTg2to5MW_NR_DIRBGas_PGE_I	3.50	-	0.2	0.3	\$0	\$0	\$0	116%	116%	116%	85%	
FC1200kW_NR_NG_PGE_I	1.20	0.2	1.0	2.9	\$0	\$0	\$0	104%	114%	115%	91%	1
FC1200kW_NR_OSBGas_PGE_I	1.20	0.2	0.8	2.2	\$0	\$0	\$0	101%	119%	124%	112%	1
FC1200kW_NR_DIRBGas_PGE_I	1.20	0.2	0.8	2.2	\$0	\$0	\$0	107%	118%	120%	97%	1
FC1200kWe_NR_NG_PGE_I	1.20	0.2	0.3	0.5	\$0	\$0	\$0	91%	101%	100%	86%	
FC1200kWe_NR_OSBGas_PGE_I	1.20	0.1	0.2	0.3	\$0	\$0	\$0	87%	100%	101%	100%	1
FC1200kWe_NR_DIRBGas_PGE_I	1.20	0.1	0.2	0.3	\$0	\$0	\$0	93%	104%	104%	92%	1
MT200kW_NR_NG_PGE_I	0.20	0.6	6.6	33.2	\$0	\$0	\$0	105%	106%	105%	98%	1

Figure 8-5 presents installed capacity in megawatts for all equipment adopted in the years specified by the user on the technology level summary sheet. As a reminder, changing the value of years on that sheet will change the years presented in the graphics in Figure 8-5 as well as the numerical values presented on in the workbook. The installed capacity is calculated using the results from the individual runs and multiplying these values by the adoptions stored in this workbook for each technology. The columns labeled Adoptions – MW on this tab are where the data are stored for these graphs.

Figure 8-5: Graphical View of Installed Capacity (MW)

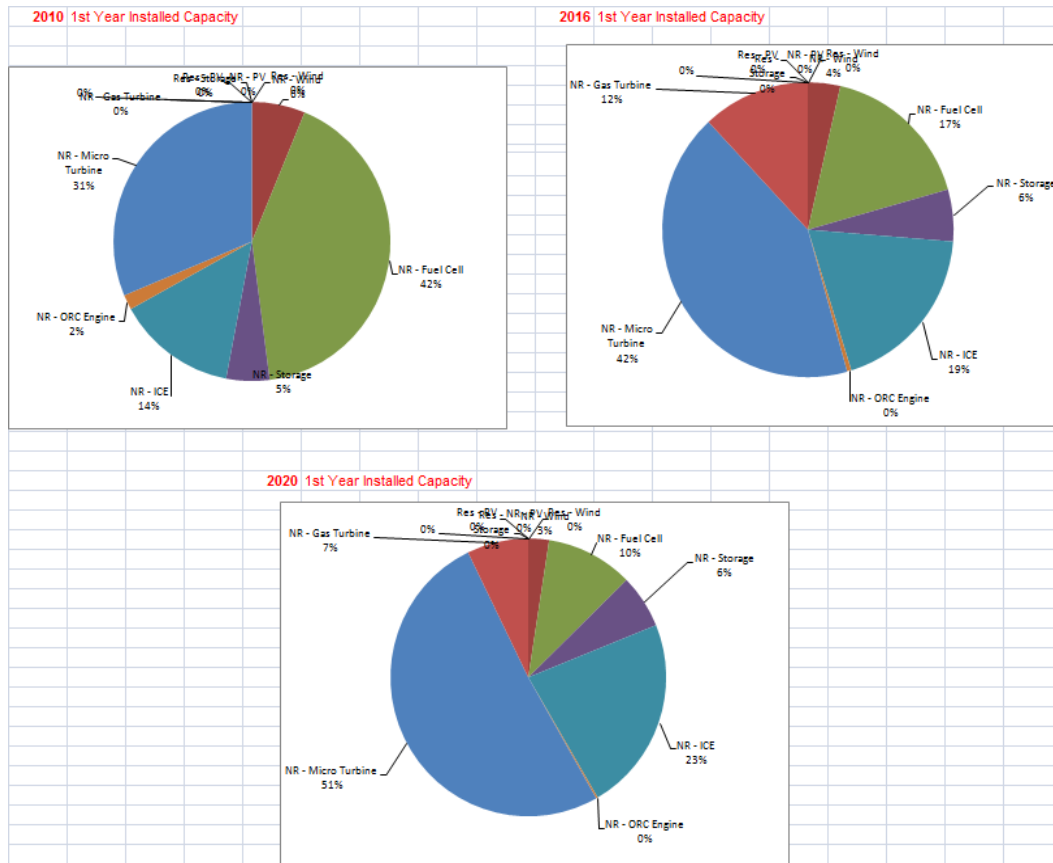

In Figure 8-6 the user can view the benefit/cost ratios graphically for the three tests that have been calculated in the workbook. As with all the other calculations on this sheet, the user can change the three years presented by changing the value of the years on the technology summary page, if desired. These graphs show the overall technology level results as well as the total portfolio of results for the batch run.

Figure 8-6: Graphical View of Benefit/Cost Ratios

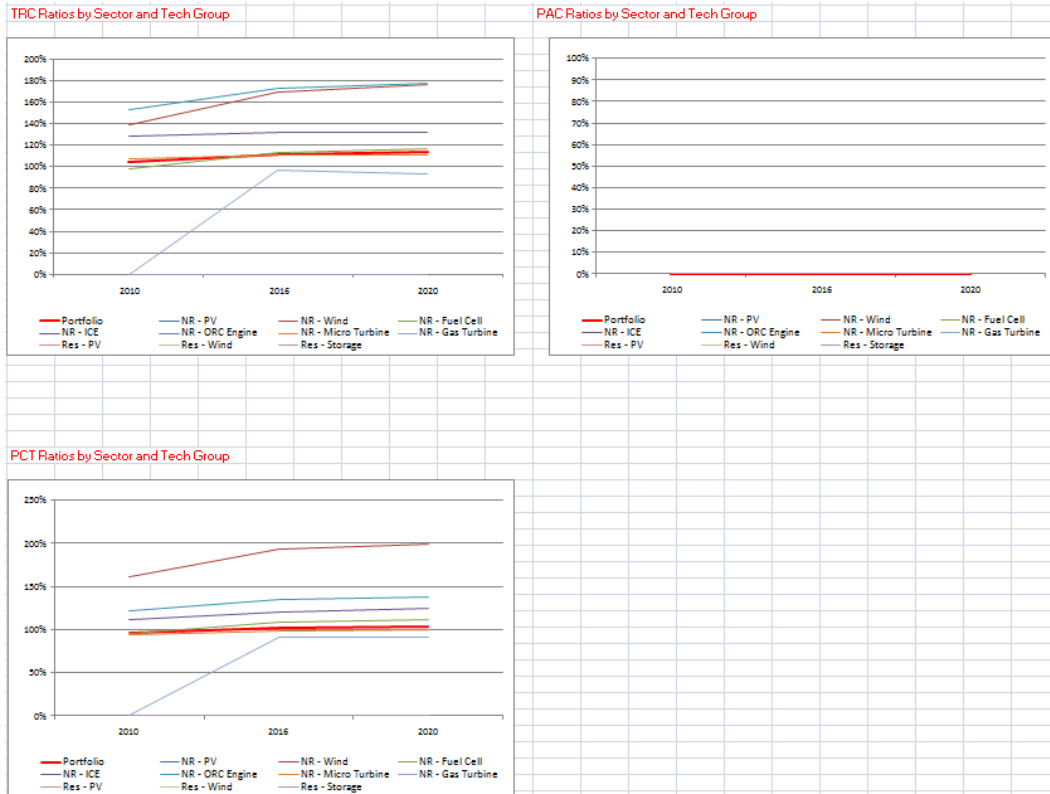

Template Worksheet

This worksheet, shown in Figure 8-7, is used to create a place for results to be placed. A copy of this tab is made by the system just before copying the results from a simulation. The name of the tab is set to the same name as the Calc Engine so that the information can be easily linked. Note that the worksheet should not be altered by the user as range names or cell positions might be changed and disable the system.

The bottom section of the worksheet holds the data copied from the Results tab in the Calc Engine. The worksheet has an identical set of line items as the corresponding worksheet in the Calc Engine. The values from the calculation are copied into this area and the upper portion of the worksheet is recalculated for use by the summary pages.

The top most part of the template is populated with the information from the cover page in the Calc Engine. This ensures that there is no confusion about what technology combination was used to generate the results found in each worksheet.

Figure 8-7: Template Worksheet

SGIPce Results								
	Run Number	Fuel Type	CZ Region	Prgrs Ratio	Expected Cap. Fac.			
	Tech Name	Utility	Finance Optn	Tech Seen Desc				
	Sector	Utility Rate	Rebate Type	Tech Suffix				
Benefit/Cost Test Calculations	Discount Rate	2007	2008	2009	2010	2011	2012	2013
TRC								
TRC Benefits		\$0	\$0	\$0	\$0	\$0	\$0	\$0
TRC Costs		\$0	\$0	\$0	\$0	\$0	\$0	\$0
TRC Net Benefits		\$0	\$0	\$0	\$0	\$0	\$0	\$0
TRC Benefits Ratio		0.0%	0.0%	0.0%	0.0%	0.0%	0.0%	0.0%
TRC - Societal								
TRC - Societal Benefits		\$0	\$0	\$0	\$0	\$0	\$0	\$0
TRC - Societal Costs		\$0	\$0	\$0	\$0	\$0	\$0	\$0
TRC - Societal Net Benefits		\$0	\$0	\$0	\$0	\$0	\$0	\$0
TRC - Societal Benefits Ratio		0.0%	0.0%	0.0%	0.0%	0.0%	0.0%	0.0%
PCT								
PCT Benefits		\$0	\$0	\$0	\$0	\$0	\$0	\$0
PCT Costs		\$0	\$0	\$0	\$0	\$0	\$0	\$0
PCT Net Benefits		\$0	\$0	\$0	\$0	\$0	\$0	\$0
PCT Benefits Ratio		0.0%	0.0%	0.0%	0.0%	0.0%	0.0%	0.0%
PA								
PA Benefits		\$0	\$0	\$0	\$0	\$0	\$0	\$0
PA Costs		\$0	\$0	\$0	\$0	\$0	\$0	\$0
PA Net Benefits		\$0	\$0	\$0	\$0	\$0	\$0	\$0
PA Benefits Ratio		0.0%	0.0%	0.0%	0.0%	0.0%	0.0%	0.0%
Levelized Lifetime Values	Discount Rate	2007	2008	2009	2010	2011	2012	2013
Levelized Cost of Generation (\$/kWh)								
% Financed w/ equity								
Upfront rebate	Participant							
	Societal							

Other Worksheets

The balance of the worksheets, found in the Results workbook, have been placed there by the system. In the batch run, each technology combination generates a new tab in the Results workbook, like the one shown in Figure 8-8. As mentioned before, the system makes a copy of the Template worksheet, changes its name to the name of the technology combination, and pastes the results for the Results tab in the Calc Engine into this new worksheet. The system also adds the technology combination name to the list of technologies found in the SummaryStats_perUnit sheet. This list is used to lookup the results from these technology tabs for inclusion into the results.

Figure 8-8: Technology Combination Results Workbook Example

SGIPce Results											
Run Number	146	Fuel Type	None	CZ Region	Inland	Prgrs Ratio	NA	Expected Cap. Fac.		Actual	
Tech Name	Storage (1 MW)	Utility	PG&E	Finance Optn	Debt/Equity	Tech Seen Date	NA				
Sector	Commercial	Utility Rate	A10TOU	Rebate Type	None	Tech Suffix	Storage1MW_NR_NA_PGE_I				
Benefit/Cost Test Calculations		Discount Rate	2007	2008	2009	2010	2011	2012	2013	2014	
TRC											
TRC Benefits			\$325,743	\$325,886	\$333,369	\$338,037	\$342,118	\$346,668	\$351,666	\$357,12	
TRC Costs			\$682,515	\$671,119	\$665,901	\$655,749	\$645,187	\$634,992	\$625,299	\$616,37	
TRC Net Benefits			(\$356,772)	(\$345,233)	(\$332,531)	(\$317,712)	(\$303,068)	(\$288,424)	(\$273,734)	(\$259,25	
TRC Benefits Ratio			47.7%	48.6%	50.1%	51.5%	53.0%	54.6%	56.2%	57.9	
TRC - Societal											
TRC - Societal Benefits			\$327,412	\$328,632	\$335,835	\$340,674	\$345,116	\$349,946	\$355,301	\$361,18	
TRC - Societal Costs			\$616,500	\$607,177	\$602,879	\$594,468	\$585,823	\$577,579	\$569,845	\$562,82	
TRC - Societal Net Benefits			(\$289,088)	(\$278,545)	(\$267,044)	(\$253,794)	(\$240,707)	(\$227,633)	(\$214,544)	(\$201,64	
TRC - Societal Benefits Ratio			53.1%	54.1%	56.7%	57.3%	58.9%	60.6%	62.4%	64.2	
PCT											
PCT Benefits			\$396,066	\$398,294	\$401,228	\$404,771	\$408,838	\$413,462	\$418,674	\$424,50	
PCT Costs			\$804,459	\$799,373	\$795,157	\$789,816	\$785,248	\$781,457	\$778,490	\$776,36	
PCT Net Benefits			(\$408,393)	(\$401,080)	(\$393,929)	(\$385,045)	(\$376,410)	(\$367,995)	(\$359,816)	(\$351,86	
PCT Benefits Ratio			49.2%	49.8%	50.5%	51.2%	52.1%	52.9%	53.8%	54.7	
PA											
PA Benefits			\$0	\$0	\$0	\$0	\$0	\$0	\$0	\$	
PA Costs			\$0	\$0	\$0	\$0	\$0	\$0	\$0	\$	
PA Net Benefits			\$0	\$0	\$0	\$0	\$0	\$0	\$0	\$	
PA Benefits Ratio			0.0%	0.0%	0.0%	0.0%	0.0%	0.0%	0.0%	0.0	
Levelized Lifetime Values		Discount Rate	2007	2008	2009	2010	2011	2012	2013	2014	
Levelized Cost of Generation (\$/kWh)			\$0.39	\$0.39	\$0.39	\$0.38	\$0.38	\$0.38	\$0.37	\$0.3	
% Financed w/ equity			60.0%	60.0%	60.0%	60.0%	60.0%	60.0%	60.0%	60.0	
Upfront rebate											
	Participant		\$0	\$0	\$0	\$0	\$0	\$0	\$0	\$	
	Societal		\$0	\$0	\$0	\$0	\$0	\$0	\$0	\$	
	Utility		\$0	\$0	\$0	\$0	\$0	\$0	\$0	\$	

9

How To Change It

9.1 Introduction

This section is designed to show the user how to set up some basic scenarios by explaining the fields in the SGIPce Technology Description list. In addition, this section will highlight areas that the user may change manually for other scenarios that they may want to create. The SGIPce is setup to be very flexible with respect to adjusting inputs, but some inputs need to be changed manually to affect the desired impact. This section will attempt to go through these concepts and make it clear how and where inputs are changed.

9.2 Parameters in the Technology Definitions Table

When starting SGIPce, Section 4 goes through the steps of setting up the Global Assumptions and the “Buttons”. Please refer to that section for information about using the fields in Global Assumptions and the functions of the buttons.

With respect to the Technology Definitions table in SGIPce, this table has been set up to allow the user to change the way the system runs each technology (e.g., does it receive an incentive or not). Scenarios may be set up by the user utilizing the fields in this table.

This section discusses the various fields found in the Technology Definition table. It is the intent of this section to present some of the variables that can be changed in the system. Please refer to other sections of the User Guide and the SGIPce Report for an explanation of these variables, their values, and the cost-effectiveness framework.

Please note that there are some specific rules about what may and what may not be edited in the SGIPce workbook. Microsoft Excel’s protection capabilities were not implemented in the workbook because of the restrictive nature of this capability. Please make note of the fields that are indicated as not editable. Changes to these fields will very likely cause a malfunction in the system.

9.2.1 Technology Definitions List

- The Technology Definitions list is found on the front page of the SGIPce workbook. The system will open to this page automatically each time you open the workbook.
- The Technology Definitions list is a list of technologies defined by the CPUC for investigation by the evaluation team.
 - No lines may be added to this list.
 - No changes to the fields in this list should be made, other than those mentioned here and in Section 4.
- The columns are color-coded.
 - If the columns alter between green and white then they are editable by the user.
 - If the columns are solid green then they must not be changed.
- The Technology Definitions list may be filtered.
 - The down-arrows in each column header allow the user to filter on specific lines in the list.
 - Please do not confuse these down-arrows with the ones that show up when a cell is selected. These arrows are explained later in this section.
 - It is strongly suggested that the *Clear Filter* button be pressed and the reset buttons be pressed before setting up a new run. Please see Section 4 for more detail on this.
 - The filtering system allows the user to select any or all lines based on the values found in the columns.
 - For example, the filter on the Technology Name column lists all technologies available in the list. To hide technologies in the list simply clear the checkboxes next to the technology names to be hidden and select *Ok*. The unchecked technologies will no longer be visible until the filter is clear.
 - The filtering system is cumulative.
 - The user may combine any combination of filters in the list to limit the list to the specific group of lines desired.
 - Filtering a technology so that it is hidden is not equivalent to the technology being eliminated from a cost-effectiveness run. Inclusion or exclusion from a run is solely determined by the “Run Technology Flag”.
 - Once they are done with that set of filters they can press the *Clear Filters* button and all lines in the list will reappear.

9.2.2 Fields in the Technology Definition List

- Identifier and Scenario Fields in the Technology Definitions list
 - The columns that are green are identifiers and should never be edited.
 - These fields include Run Number, Technology Name, Sector, Fuel Type, Utility, Climate Region and Error Condition.
 - *Error Condition* should never have a value in it. If anything is seen in this column then the list has been edited incorrectly and needs to be restored before continued use.
 - ◆ The best way to solve this situation is for the user to get a new copy of *SGIPce.xlsm* from the compressed file that was downloaded.
 - The columns that alternate green and white are editable by the user.
 - These fields include *Run Technology Flag*, *Utility Rate*, *Financing Option*, *Rebate Type*, *Progress Ratio*, *Technology Scenario Description*, and *Expected Capacity Factor*.
 - These fields are considered Scenario fields.
- Using Scenario Fields
 - Most of the Scenario fields have drop-downs containing the allowable values for the field. These values must be used for the system to function properly.
 - Please **do not** confuse these drop-down arrows with the filters arrows found in the column headers at the top of the table. The filter arrows do not perform the same function as the drop-down arrows that show up when you enter a field to select a new value.
 - The drop-down arrows are only visible if the cursor is in a Scenario field in the non-column header row. The filter arrows are always visible in the column header row.
 - Judicious copy and paste may be used when setting up these fields.
 - It is okay to copy a value from one cell and paste it into one or more cells below that should take on the same value, but please use care when doing this.
 - *Utility Rate* would be an exception to this since the rates vary by utility. Care must be taken when setting this field.
 - Paste will only put the copied value in the visible cells in the table
 - For example: after filtering the list the user may select *Yes* for the first cell in *Run Technology Flag* and copy that value to all other visible lines in the filter list for that column. The values in the hidden cells will not be changed.

- Following is a list of fields for use in user-defined scenarios.
 - *Run Technology Flag*
 - Identifies the technology line the user wants in their scenario.
 - *Yes* indicates include in scenario
 - *No* indicate do not include in scenario
 - *Utility Rate*
 - A line's Utility Rates keys off the value of Utility and Sector to present the allowable values for the field in the dropdown.
 - There are two rates defined for each Utility and Sector.
 - These rates were selected to be representative of the most likely rates encountered by the customers in the service territory.
 - While adding new rates is possible, the system is not setup in a way for the user to do this on their own. A request for this should be submitted to the CPUC for evaluation and possible addition to the system.
 - *Financing Option*
 - Each technology line may be run with either Debt/Equity financing or Power Purchase Agreement (PPA)/Commercial financing.
 - Debt/Equity financing uses 60% equity for the Non-residential sector and 40% equity for Residential and Government/Non-profit sectors by default.
 - ◆ The Debt/Equity distribution can be changed by the user in the *SGIPce_Inputs_Global.xlsx* workbook on the tab named *Global_Financing*.
 - Row 94, columns D, E, & F hold the default values.
 - Be sure to make a copy of the original workbook so that you can go back to the default values if desired.
 - PPA/Commercial Financing starts with a value of 60% for percent equity financed, but finds the actual value for equity financing using a goal seeking routine that sets to zero the following equation:
 - ◆ $(\text{Cash Flow Available for Debt Service over the debt term}) - (\text{Total Cash Flow Available for Debt Service required})$
 - ◆ The equation of the difference may be viewed in the Calculation Engine in the LCOE ProForma worksheet on Row 141, Column C.
 - ◆ If a value cannot be found for a given technology then the default value is used for that technology.

- ◆ ***Please note that setting a technology to run under PPA/Commercial financing significantly increases the run time due to the need for the goal seek functionality in Microsoft Excel.***
- *Rebate Type*
 - There are three values to select for this field (i.e. *None, PBI, EPBB*)
 - *None* tells the system that no rebates should be paid for the given technology line item.
 - *PBI* distributes the rebate received by the consumer over five years and is based on the level of production during those five years.
 - *EPBB* is an upfront rebate that is paid in the first year of operation.
 - The values for these rebates are set in the individual technology workbooks (e.g. *SGIPce_Inputs_Tech_FC1200kW_NR_NG.xlsx*) found in the Inputs folder under SGIPce.
 - Look in the AnnualInputs tab of each technology workbook on line 35 for EPBB and line 39 for PBI.
 - ***Changes to these values may be made in these workbooks and saved for use by the system. Please be sure to make a copy of the workbook as a backup to return to the default values if needed.***
- *Progress Ratio*
 - The progress ratio is an input to the learning curve used to predict system prices over time.
 - Default values for progress ratio have been estimated as a part of developing this system, but the user may substitute their own values for this parameter if desired.
 - Allowable values for Progress Ratio in the Technology Definition Table fall between greater than zero and 1. Values outside this range will cause an error condition.
 - The actual value used may be viewed in the calculation engines on the Cover tab in the cell labeled Progress Ratio Override.
- *Technology Scenario Description*
 - This field is used to help identify the technology level scenario that is being run.
 - It is informational in nature only.
 - The value of this field is presented on the cover page of the calculation engines labeled Technology Scenario Descriptor.
 - This field must be manually changed.

- There are currently three allowable values:
 - *NA* indicating that neither of the two values below has been changed for the current technology.
 - *CapFac* indicating that a user defines Expected Capacity Factor has been defined for this technology line item.
 - *ProgRatio* indicating that a user defined value for the progress ratio has been defined for this technology line item.
- Using this field is purely at the discretion of the user. Care should be taken to assure that it is set properly given the scenario defined, if used.
- *Expected Capacity Flag*
 - The adjustment to the default capacity factor has been implemented as an adjustment to the default production curve defined for each technology.
 - There are two different types of inputs allowed in this field:
 - The word *Actual* placed in this field tells the system to use the default production curves as they are stored in the technology workbooks.
 - A decimal value that is greater than zero and less than or equal to 1 ($0 < \text{adjustment} \leq 1$) may be used to adjust the default production curve so that it produces an average annual capacity factor of the user defined value.
 - ◆ Note that limits are necessary when making this adjustment. Because it is possible to exceed 1.0 in any given hour to obtain the Expected Capacity Factor, a limit on the hourly values is necessary to prevent extreme values. The hourly values of the production curves are limited to no more than 1.05 to mitigate this issue.
 - ◆ Because of this limit the Expected Capacity Factor may not be fully attained for some technologies.
 - ◆ The final calculated value for any given technology run may be viewed in the individual calculation engines if they are saved. On the Technology tab in these workbooks on Row 7, Col D the adjusted capacity factor is presented.
 - ◆ On the Cover tab of each calculation engine the Expected Capacity Factor, set by the user, is presented for review.

9.3 Manual Changes to Inputs

There are other inputs that can be changed, but no formal method of changing them has been developed. As the user looks through the comments made above they will see more closely the structure of the model and how the inputs are stored. This section discusses a few potential inputs that might be of interest to the user for further analysis. The section will show the user how to manually make changes to a few of these inputs. As the user discovers more of these inputs it may be desirable to more formally develop a method to change inputs as part of the scenario runs. Requests for these changes should be forwarded to the CPUC for evaluation and possible inclusion into future versions of this software. One example of a possible concept that must be manually changed has to do with sites that use on-site biogas. This change along with other inputs are discussed next.

9.3.1 On-site Biogas (OSBG)

SGIPce is set up to handle the capital costs and CO₂ benefits for on-site biogas (OSBG) projects in two distinct ways, depending on the size of the project. OSBG-powered projects greater than 500 kW in size are assumed to be associated with facilities where biogas is already captured. Examples include landfills and waste water treatment facilities. These facilities are required by environmental and safety regulations to capture and flare methane generated at the site. In these instances, SGIPce does not allocate capital costs to a biogas digestion system as these systems are assumed to already be in place. Additionally, SGIPce does not allocate CO₂ benefits associated with capture of methane in these projects as the biogas is assumed to be flared. As such, the power generation project cannot be credited with capturing methane that is already being captured and sent to a flare as a “baseline” condition.

For OSBG-powered projects equal to or smaller than 500 kW we have assumed they are associated with facilities where biogas is not already captured. Dairies are a good example of this type of facility. Unlike landfills and waste water treatment facilities, dairies are not currently required to capture and treat the biogas produced from open lagoons. As a result, the methane contained in the biogas is vented to the atmosphere, thereby acting as a potent greenhouse gas. Consequently, OSBG-powered projects for these smaller facilities incur the cost of installing a digester system in order to capture the biogas that can then be used to power the electricity generator. Similarly, these facilities are credited with CO₂ benefits associated with capture of methane. In these cases, SGIPce allocates the project with the increased capital cost associated with the biogas digester system but also allocates the project with the resulting CO₂ benefits.

The way this is implemented in the system is through a toggle in the technology workbooks. In the technology workbooks with the suffix *_OSBGas* the user can find a field on the Constants tab labeled “Is this technology installed at a Dairy”. This field is set to *Yes* if the technology is to be

estimated as if it was installed at a Dairy and *No* if it is not. The effect of setting this to *Yes* is to change the value of *Emissions Factor – CO2*, also found on the Constants tab, and to add the cost of the Anaerobic Digester to the Other Capital Costs (Other Prices not in System) found on the *AnnualInputs* tab on Row 14, Columns D, E, & F.

As mentioned above, changing this value is a manual process. Each on-site biogas technology workbook must be change separately if the user wants to change the status of this field. Please be sure to make a copy of the workbooks being changed so that the default values can be restored if desired.

9.3.2 Capital Costs

Manual changes to the concepts that follow may all be done on the same worksheet. The worksheet in question can be found in each technology workbook in the Inputs folder under SGIPce.

The inputs to Capital Costs (i.e. System Prices) are found on Rows 5 through 8 of the *AnnualInputs* worksheet in each technology workbook. The formula used to calculate these cost incorporates historical information about global capacity found in Row 6 and historical information about system prices found in Row 8. The fields that are considered user input are yellow in color and are columns C, D, E, & F. These fields may be changed by the user as desired to affect the level of Capital Cost used by the system for the selected technology. The other columns in these rows are the Learning Curve formulas and may not be changed by the user.

Column C, Row 6 is an annual escalation rate of global capacity. This value is applied to the 2009 input, which is expanded out from 2010 to 2020 in the worksheet. The user may make adjustments to this value and to the historical values found in columns D, E, & F. Only these four numbers are retrieved by SGIPce to calculate the total stream of Capital Cost. The other values in this row are presented to the user for review only.

Column C, Row 8 is the Progress Ratio used by the Learning Curve formula for estimating Capital Cost over time. As mentioned in the previous section, this value may be overridden by the user in the SGIPce Technology Definitions table. Columns D, E, & F of Row 8 holds the historical values of Capital Costs observed in 2007 through 2009. These values may be updated by the user if desired. The values from 2010 to 2020 use the Learning Curve formula and reference both the global capacity and historical system prices and may not be changed by the user. These values are presented for review only in this worksheet.

Also note that there may be references to other cells and worksheets in the historical values mentioned above. The user should spend some time reviewing the information developed on the worksheets referenced before making changes to these values.

9.3.3 O&M Costs

O&M Costs may also be found on the AnnualInputs tab of each of the technology workbooks that accompany SGIPce. Row 19 holds the inputs to the O&M cost calculation and the historical values may be changed by the user as desired.

Once again there are four cells that may be edited by the user. Row 19, Column C holds the rate at which the 2009 historical value is escalated from 2010 through 2020. Columns D, E, & F hold the observed values for O & M costs from 2007 through 2009. If different historical values are appropriate then they can be changed here.

As mentioned above, these cells may contain references to other worksheet in the technology workbook. The user would be well served to evaluate the information on the referenced worksheet before making changes.

9.3.4 Directed Bio Gas Adder

The Gas Price Adder for Directed Biogas is also found on the AnnualInputs worksheet of the technology workbooks. Row 24 contains the values for this input and the historical values may be edited by the user.

As with the O&M Costs described above, there are four cells that may be edited by the user. The cell in Column C is the escalator to be used to calculate values from 2010 through 2020 using the 2009 historical input. Columns D, E, & F are the observed values for this input that are used by SGIPce to calculate all values for this input.

Once again, these cells may contain references to other worksheet in the technology workbook. The user should review these inputs on the referenced worksheet before making changes.

9.4 Finally

As can be seen in this section and others, all of the inputs to the SGIPce system can be observed and changed if desired. Investigation of the workbooks found in the Input folder will help the user to understand what goes into the model and spur thoughts about what could be changed. This section shows ways of making changes to the obvious inputs. The same can be done to other inputs as well. Care must be taken in doing so, however.

It cannot be expressed enough that if the user wants to change input values used by the inputs to SGIPce that they should make backups of these workbooks so that they can get back to its original state. Also, if changes are made to the input files it should be noted that it may be very difficult for the developers to look at what was done and repair it. Please make changes incrementally and test frequently to be assured that SGIPce still works before proceeding to the next change. This will insure that the user can always get back to the last change that was successfully made and begin again with the next change. Good luck!

Appendix C

Graphs and Tables

Appendix C presents the SGIPce model outputs for base case scenarios for the Societal Total Resource Cost test (STRC) test, the Participant Cost test (PCT), and the Modified Internal Rate of Return (MIRR).

The first table presents the Commercial STRC results in 2010 and 2016 by technology, fuel, and utility. The table also presents the statewide average STRC results. The first set of columns presenting statewide results calculates the statewide averages using an equal weighting scheme, or 33.3% for each utility's TRC value. The second set of statewide columns weights each utility approximately equal to their share of statewide electric sale: 45% for PG&E, 45% for SCE, and 10% for SDG&E. STRC test values that exceed 1.0 indicate that the estimate of societal benefits is forecast to exceed the estimate of societal costs. Given the uncertainty in the benefit and cost estimates, and the market transformation goals of the program, technologies with STRC less than 1.0 may be considered for inclusion in the program.

Following the Commercial STRC table are Statewide STRC graphs by fuel. These graphs illustrate the STRC in 2010 and 2016 for evaluated technologies by their respective fuels. The four evaluated fuel choices are non-combustion fuels, on-site biogas, directed biogas, and natural gas. Reviewing these figures helps to illustrate the influence of fuel choice on the cost-effectiveness of DG technologies. For example, many of the on-site biogas technologies are more cost-effective than natural gas technologies because on-site biogas technologies pay a higher upfront and O&M costs but do not need to pay an ongoing fueling cost like natural gas technologies.

Following the Commercial STRC figures are Government and Residential STRC tables. These tables list information similar to the information found in the Commercial STRC tables.

The Government and Residential STRC tables are followed by Commercial STRC table estimated with actual EPBB rebate values. Traditionally, rebates do not influence the value of the STRC test, but the inclusion of federal income tax benefits in the STRC leads to an indirect influence of rebates on STRC. While the EPBB STRC values are slightly lower than the no rebate STRC (due to the taxable nature of rebates), they are not substantially different from the no rebate STRC values presented earlier. The Commercial STRC results are followed by those for Government and Residential.

Following the table of EPBB STCR results are figures of STCR results by technology for each fuel, sector, and utility. These tables illustrate how the STCR varies for a given technology by the fuel used to generate the electricity, by sector, and by utility. The STCR values generally vary more by fuel than they do by utility. In the figures, the STCR values for 2010 are illustrated in a darker color than the STCR results for 2016. A solid line at 1.0 helps to designate those technologies that “pass” the STCR test. The dotted line at 0.80 designates a set of technologies that may be close enough to passing the STCR test given the inherent uncertainties in the input values.

Following the STCR results by technology are STCR figures by fuel for a given sector and utility. These figures illustrate the differing values of cost-effectiveness by technology holding fuel, sector, and utility constant.

The PCT results table for Commercial, No Rebate lists the value of the PCT cost-effectiveness test and the MIRR for 2010 assuming no rebates. If the PCT exceeds 1.0, the DG technology is forecast to improve the well being the host site without program rebates. A PCT test value of 1.0 or higher however, does not imply that other firms will be eager to install DG technologies without program rebates. Other barriers may inhibit installation. The PCT test values include columns by utility and statewide values. The statewide values were calculation once using equal utility weighting and once using electric sales weighting.

The PCT table of results is followed by PCT graphs which illustrate the PCT test for a given sector and fuel by utility and technology. These graphs show that the PCT test varies substantially by technology and fuel. The graphs also show that the PCT is more sensitive to utility than the TRC. The utility sensitivity of the PCT is due to the different utility rate structures.

Following the Commercial PCT graphs are tables of no rebate PCT results for the government and residential sectors. The PCT cost-effectiveness test values are highly sensitive to program rebates. The Commercial PCT tables with actual EPBB rebates in 2010 are available next. Many technologies, however, do not have rebates in 2010.

Following the PCT EPBB tables are PCT/MIRR graphs by technology, utility, and sector. The graphs illustrate the PCT and MIRR if the DG technology does not receive a rebate (red square), receive the actual program rebate (green triangle), or if the technology receives alternative rebate values needed to attain a desired MIRR value. The evaluation attempted to determine the rebate value necessary to reach MIRR from 10% to 15%. If the technology, however, was not cost-effective from the point of view of the participant, it may not have been possible to reach a 10% MIRR without providing a rebate in excess of the measure costs. For these technologies, the PCT/MIRR graphs is a single point at zero representing the inability to find an acceptable rebate (for example, Fuel Cells in the government sector fueled by directed biogas in SDG&E’s service

territory). The PCT/MIRR graphs do not present PCT/MIRR combinations that required negative rebates (the site pays the utility) or rebate levels exceeding the cost of the measures. The evaluation team followed current SGIP rules, which do not allow a rebate to exceed the cost of the DG technology.

SGIP Cost Effectiveness Report

TRC Results

Commercial

Technology	SGIPce System Size (kW)	PG&E		SCE		SDG&E		Statewide - Equal		Statewide - Elec Sales	
		TRC - 2010	TRC - 2016	TRC - 2010	TRC - 2016	TRC - 2010	TRC - 2016	TRC - 2010	TRC - 2016	TRC - 2010	TRC - 2016
Wind Turbine											
- 1 MW	1,000	1.39	1.70	1.41	1.73	1.40	1.72	1.40	1.72	1.40	1.72
Fuel Cell - Electric Only											
- Natural gas	1,200	0.91	1.01	0.92	1.02	0.94	1.04	0.92	1.02	0.92	1.01
- On site biogas	1,200	0.86	1.00	0.87	1.01	0.88	1.03	0.87	1.01	0.87	1.00
- Directed biogas	1,200	0.93	1.04	0.94	1.05	0.96	1.07	0.94	1.05	0.94	1.04
Fuel Cell - CHP (i.e., w/waste heat recovery)											
- Natural gas powered	1,200	1.03	1.14	1.04	1.15	1.07	1.18	1.05	1.16	1.04	1.15
- On site biogas	1,200	1.01	1.18	1.01	1.19	1.03	1.22	1.02	1.20	1.01	1.19
- Directed biogas	1,200	1.07	1.19	1.07	1.19	1.10	1.22	1.08	1.20	1.08	1.19
Gas Turbine - CHP											
- Natural gas powered (1000 kW)	1,000	0.87	0.87	0.88	0.88	0.91	0.91	0.89	0.89	0.88	0.88
- On site biogas (1000 kW)	1,000	0.88	0.92	0.89	0.93	0.91	0.95	0.89	0.93	0.89	0.93
- Directed biogas (1000 kW)	1,000	0.94	0.95	0.96	0.96	0.98	0.98	0.96	0.96	0.95	0.96
- Natural gas powered (3500 kW)	3,500	1.08	1.09	1.10	1.10	1.13	1.13	1.11	1.11	1.10	1.10
- On site biogas (3500 kW)	3,500	1.16	1.22	1.17	1.23	1.20	1.26	1.18	1.24	1.17	1.23
- Directed biogas (3500 kW)	3,500	1.15	1.16	1.17	1.17	1.20	1.20	1.17	1.18	1.16	1.17
Microturbine - CHP											
- Natural gas powered	200	1.04	1.05	1.05	1.07	1.09	1.10	1.06	1.07	1.05	1.06
- On site biogas	200	1.24	1.52	1.24	1.52	1.26	1.54	1.25	1.53	1.24	1.52
- Directed biogas	200	1.12	1.14	1.13	1.15	1.17	1.18	1.14	1.16	1.13	1.15
IC Engine - CHP											
- Natural gas powered (500 kW)	500	1.20	1.21	1.22	1.23	1.26	1.27	1.23	1.23	1.21	1.22
- On site biogas (500 kW)	500	1.82	2.39	1.82	2.40	1.85	2.43	1.83	2.40	1.82	2.39
- Directed biogas (500 kW)	500	1.27	1.29	1.29	1.30	1.33	1.34	1.29	1.31	1.28	1.30
- Natural gas powered (1500 kW)	1,500	1.28	1.29	1.30	1.30	1.34	1.34	1.31	1.31	1.29	1.30
- On site biogas (1500 kW)	1,500	1.50	1.70	1.50	1.72	1.55	1.77	1.51	1.73	1.50	1.72
- Directed biogas (1500 kW)	1,500	1.35	1.37	1.37	1.39	1.42	1.43	1.38	1.39	1.37	1.38
Organic Rankine Cycle											
	500	1.52	1.71	1.53	1.73	1.57	1.78	1.54	1.74	1.53	1.73
Storage											
- Med storage	25	0.51	0.60	0.50	0.58	0.49	0.57	0.50	0.58	0.50	0.59
- Larger storage	1,000	0.57	0.68	0.56	0.66	0.53	0.62	0.55	0.65	0.56	0.66

SGIP Cost Effectiveness Report
Societal TRC Test Results

Societal TRC Test Results: Non-Combustion
Statewide · Commercial

Technology	2010	2016
WD1MW	140%	172%
ORC500kW	154%	174%
Storage25kW	50%	58%
Storage1MW	55%	65%

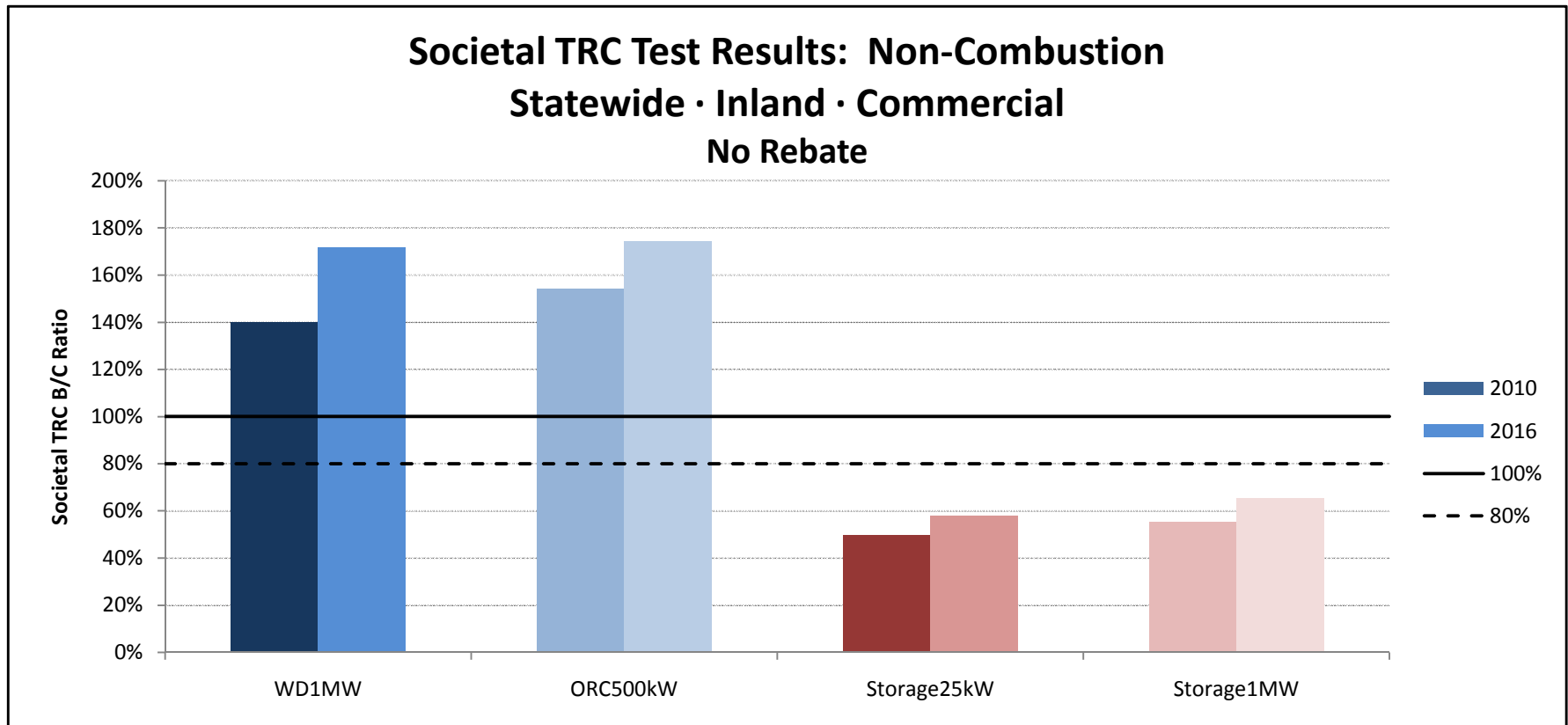

SGIP Cost Effectiveness Report
Societal TRC Test Results

Societal TRC Test Results: Onsite Bio-Gas
Statewide · Commercial

Technology	2010	2016
FC1200kWe	87%	101%
FC1200kW	102%	120%
GTg2to5MW	118%	124%
GTle2MW	89%	93%
ICE1500kW	151%	173%
ICE500kW	183%	240%
MT200kW	125%	153%

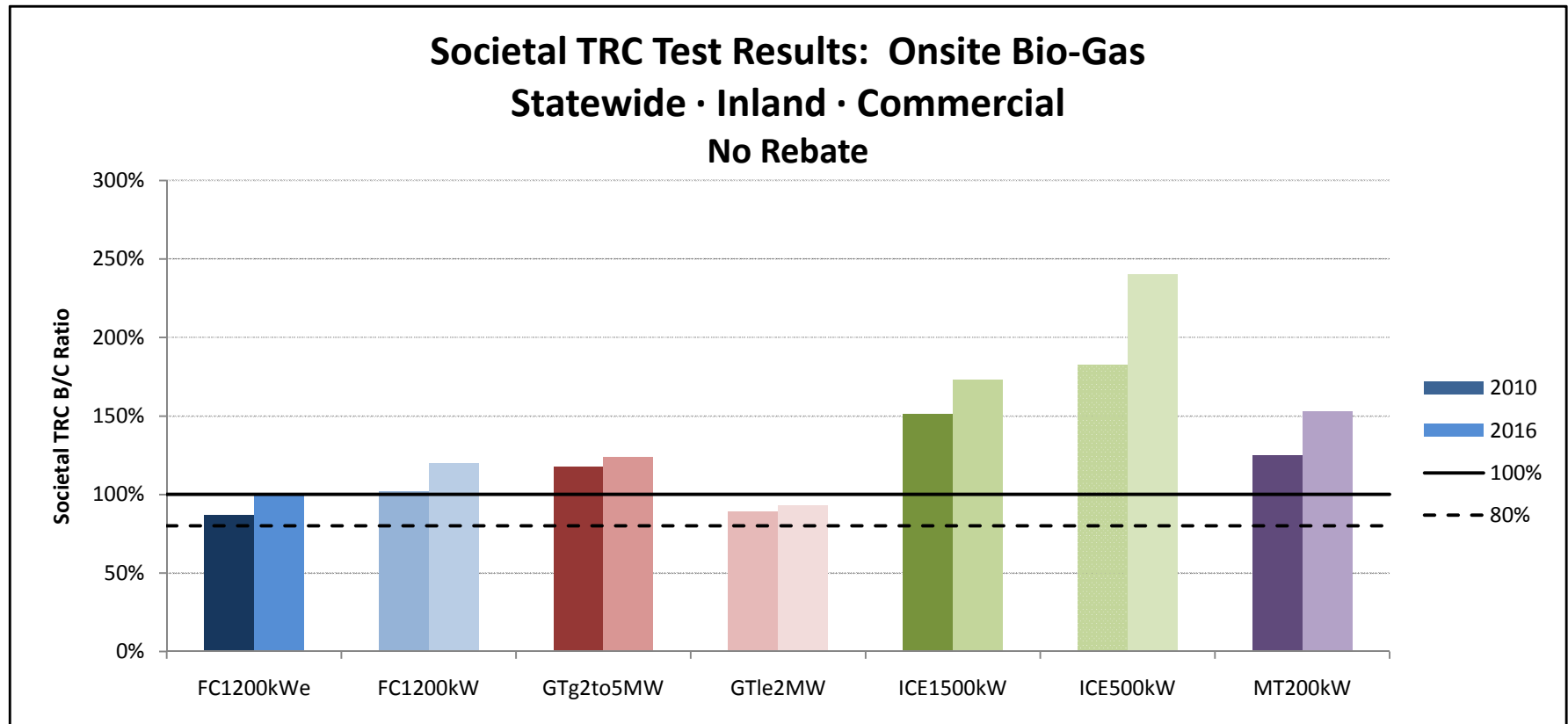

SGIP Cost Effectiveness Report
Societal TRC Test Results

Societal TRC Test Results: Direct Bio-Gas
Statewide · Commercial

Technology	2010	2016
FC1200kWe	94%	105%
FC1200kW	108%	120%
GTg2to5MW	117%	118%
GTle2MW	96%	96%
ICE1500kW	138%	139%
ICE500kW	129%	131%
MT200kW	114%	116%

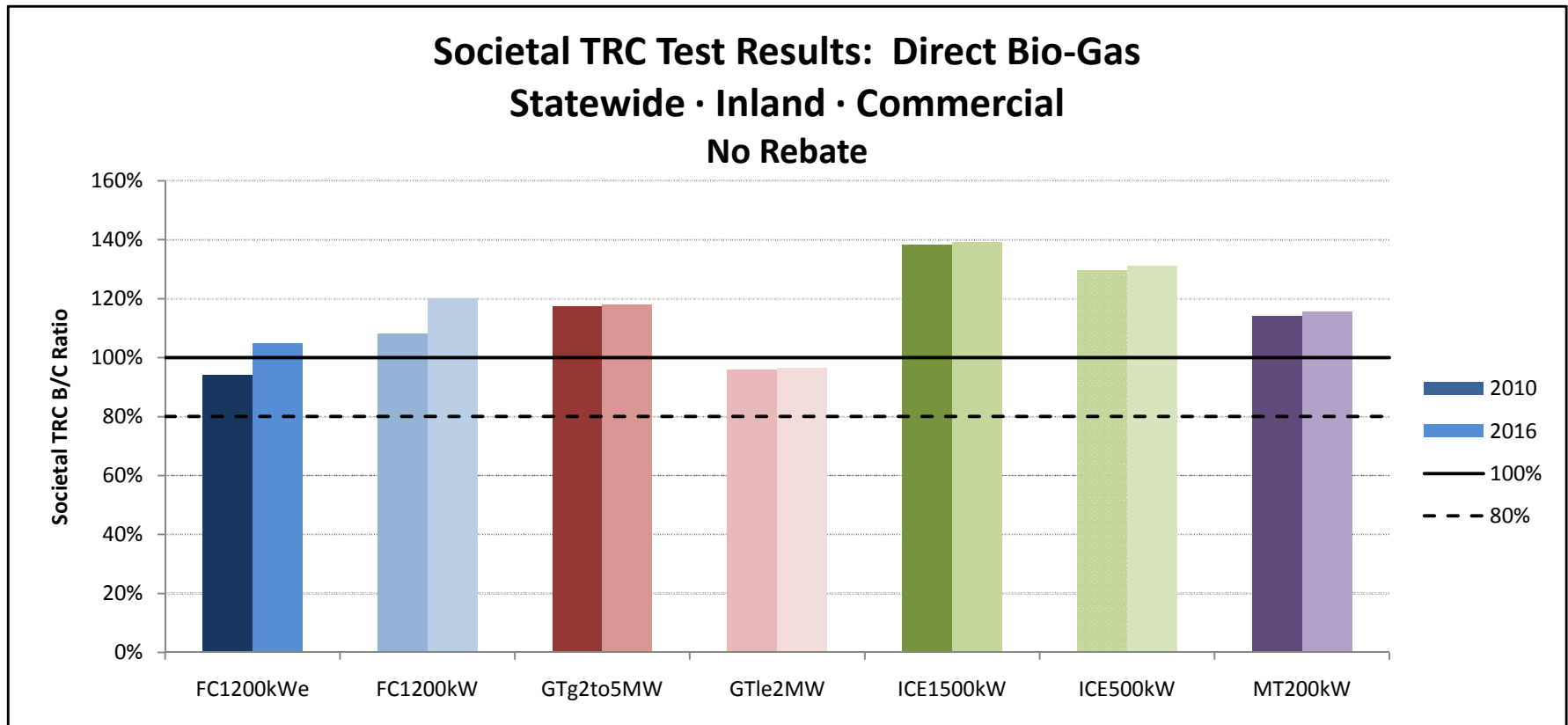

SGIP Cost Effectiveness Report
Societal TRC Test Results

Societal TRC Test Results: Natural Gas
Statewide · Commercial

Technology	2010	2016
FC1200kWe	92%	102%
FC1200kW	105%	116%
GTg2to5MW	111%	111%
GTle2MW	89%	89%
ICE1500kW	131%	131%
ICE500kW	123%	123%
MT200kW	106%	107%

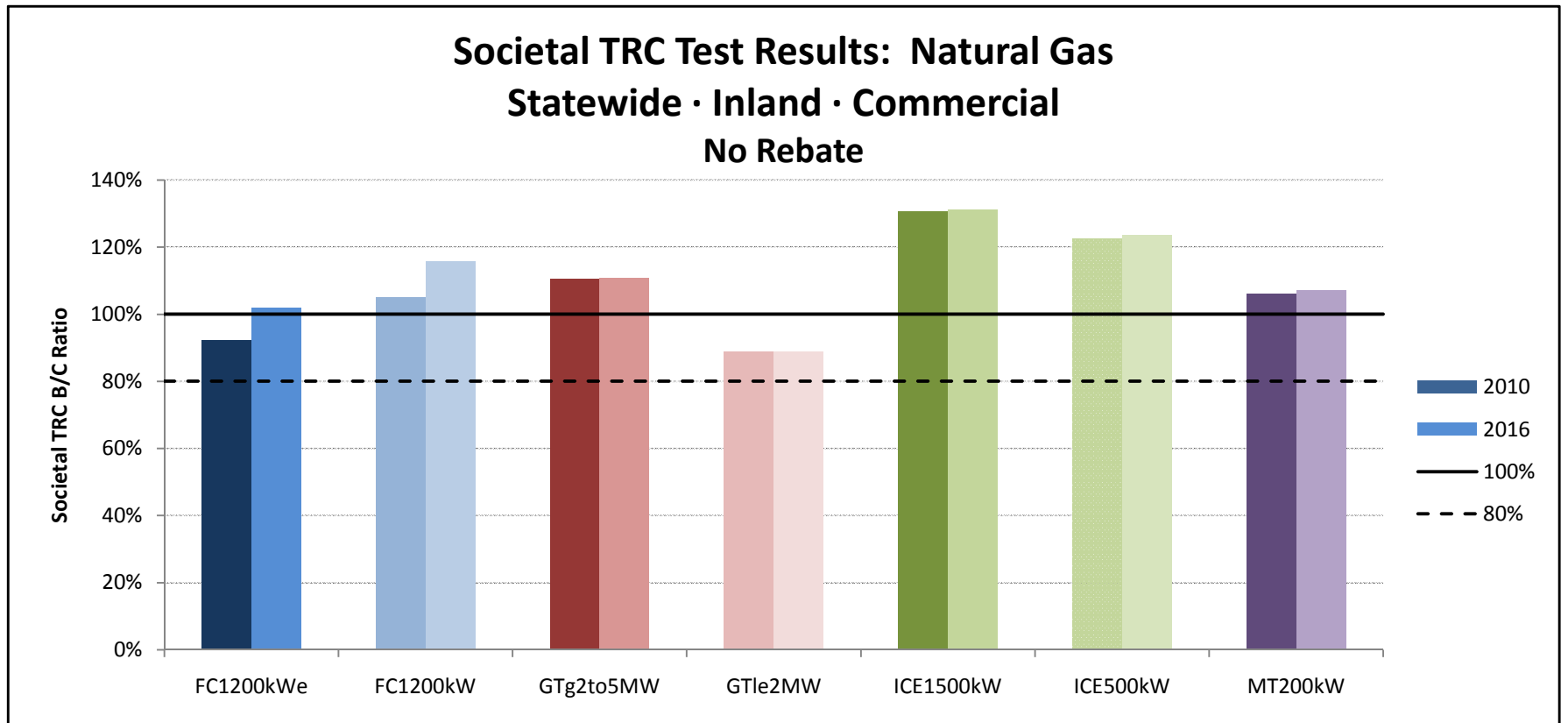

SGIP Cost Effectiveness Report

TRC Results

Government/Non-Profit

No Rebate

Technology	SGIPce System Size (kW)	PG&E		SCE		SDG&E		Statewide - Equal		Statewide - Elec Sales	
		TRC - 2010	TRC - 2016	TRC - 2010	TRC - 2016	TRC - 2010	TRC - 2016	TRC - 2010	TRC - 2016	TRC - 2010	TRC - 2016
Wind Turbine											
- 1 MW	1,000	1.06	1.42	1.08	1.45	1.08	1.44	1.07	1.43	1.07	1.43
Fuel Cell - Electric Only											
- Natural gas	1,200	0.53	0.66	0.53	0.67	0.55	0.69	0.54	0.68	0.53	0.67
- On site biogas	1,200	0.50	0.68	0.50	0.69	0.52	0.71	0.51	0.70	0.50	0.69
- Directed biogas	1,200	0.53	0.66	0.53	0.67	0.55	0.69	0.54	0.68	0.53	0.67
Fuel Cell - CHP (i.e., w/waste heat recovery)											
- Natural gas powered	1,200	0.71	0.86	0.72	0.87	0.74	0.89	0.72	0.87	0.72	0.86
- On site biogas	1,200	0.72	0.95	0.72	0.95	0.74	0.98	0.72	0.96	0.72	0.95
- Directed biogas	1,200	0.71	0.86	0.72	0.87	0.74	0.89	0.72	0.87	0.72	0.86
Gas Turbine - CHP											
- Natural gas powered (1000 kW)	1,000	0.63	0.65	0.64	0.65	0.65	0.67	0.64	0.66	0.63	0.65
- On site biogas (1000 kW)	1,000	0.71	0.77	0.71	0.78	0.73	0.80	0.71	0.78	0.71	0.78
- Directed biogas (1000 kW)	1,000	0.63	0.65	0.64	0.65	0.65	0.67	0.64	0.66	0.63	0.65
- Natural gas powered (3500 kW)	3,500	0.86	0.88	0.87	0.89	0.90	0.92	0.88	0.90	0.87	0.89
- On site biogas (3500 kW)	3,500	1.05	1.13	1.05	1.14	1.08	1.17	1.06	1.14	1.05	1.14
- Directed biogas (3500 kW)	3,500	0.86	0.88	0.87	0.89	0.90	0.92	0.88	0.90	0.87	0.89
Microturbine - CHP											
- Natural gas powered	200	0.84	0.87	0.85	0.88	0.88	0.90	0.86	0.89	0.85	0.88
- On site biogas	200	1.02	1.33	1.02	1.33	1.04	1.35	1.03	1.34	1.02	1.33
- Directed biogas	200	0.84	0.87	0.85	0.88	0.88	0.90	0.86	0.89	0.85	0.88
IC Engine - CHP											
- Natural gas powered (500 kW)	500	0.99	1.02	1.00	1.03	1.04	1.06	1.01	1.04	1.00	1.03
- On site biogas (500 kW)	500	1.65	2.28	1.66	2.29	1.69	2.32	1.67	2.30	1.66	2.29
- Directed biogas (500 kW)	500	0.99	1.02	1.00	1.03	1.04	1.06	1.01	1.04	1.00	1.03
- Natural gas powered (1500 kW)	1,500	1.07	1.10	1.09	1.11	1.12	1.14	1.10	1.12	1.09	1.11
- On site biogas (1500 kW)	1,500	1.44	1.71	1.45	1.73	1.49	1.77	1.46	1.74	1.45	1.72
- Directed biogas (1500 kW)	1,500	1.07	1.10	1.09	1.11	1.12	1.14	1.10	1.12	1.09	1.11
Organic Rankine Cycle											
	500	1.24	1.46	1.25	1.48	1.30	1.53	1.27	1.49	1.25	1.47
Storage											
- Med storage	25	0.19	0.26	0.19	0.26	0.20	0.27	0.19	0.26	0.19	0.26
- Larger storage	1,000	0.23	0.31	0.23	0.31	0.23	0.31	0.23	0.31	0.23	0.31

SGIP Cost Effectiveness Report

TRC Results

Residential

No Rebate

Technology	SGIPce System Size (kW)	PG&E		SCE		SDG&E		Statewide - Equal		Statewide - Elec Sales	
		TRC - 2010	TRC - 2016	TRC - 2010	TRC - 2016	TRC - 2010	TRC - 2016	TRC - 2010	TRC - 2016	TRC - 2010	TRC - 2016
Wind Turbine											
- 10 kW	10	0.60	0.74	0.61	0.75	0.61	0.74	0.61	0.74	0.61	0.74
Fuel Cell - Electric Only											
- Natural gas powered	5	0.73	0.95	0.74	0.96	0.74	0.97	0.74	0.96	0.73	0.96
Storage											
- Med storage	25	0.22	0.28	0.22	0.29	0.23	0.30	0.22	0.29	0.22	0.29

SGIP Cost Effectiveness Report

TRC Results

Commercial

w/ Actual EPBB Rebate

Technology	SGIPce System Size (kW)	PG&E		SCE		SDG&E		Statewide - Equal		Statewide - Elec Sales	
		TRC - 2010	TRC - 2016	TRC - 2010	TRC - 2016	TRC - 2010	TRC - 2016	TRC - 2010	TRC - 2016	TRC - 2010	TRC - 2016
Wind Turbine											
- 1 MW	1,000	1.17	1.45	1.20	1.49	1.18	1.47	1.18	1.47	1.18	1.47
Fuel Cell - Electric Only											
- Natural gas	1,200	0.87	0.96	0.88	0.97	0.90	0.99	0.88	0.98	0.87	0.97
- On site biogas	1,200	0.79	0.92	0.80	0.93	0.81	0.95	0.80	0.93	0.80	0.93
- Directed biogas	1,200	0.85	0.96	0.86	0.97	0.88	0.99	0.87	0.97	0.86	0.97
Fuel Cell - CHP (i.e., w/waste heat recovery)											
- Natural gas powered	1,200	0.98	1.09	0.99	1.10	1.02	1.13	1.00	1.11	0.99	1.10
- On site biogas	1,200	0.92	1.09	0.93	1.10	0.94	1.12	0.93	1.10	0.93	1.10
- Directed biogas	1,200	0.99	1.11	0.99	1.11	1.01	1.13	0.99	1.12	0.99	1.11
Gas Turbine - CHP											
- Natural gas powered (1000 kW)	1,000	0.87	0.86	0.88	0.87	0.91	0.89	0.89	0.87	0.88	0.87
- On site biogas (1000 kW)	1,000	0.88	0.89	0.89	0.90	0.91	0.92	0.89	0.91	0.89	0.90
- Directed biogas (1000 kW)	1,000	0.94	0.93	0.96	0.94	0.98	0.96	0.96	0.94	0.95	0.94
- Natural gas powered (3500 kW)	3,500	1.08	1.08	1.10	1.10	1.13	1.12	1.11	1.10	1.10	1.09
- On site biogas (3500 kW)	3,500	1.16	1.20	1.17	1.22	1.20	1.24	1.18	1.22	1.17	1.21
- Directed biogas (3500 kW)	3,500	1.15	1.15	1.17	1.16	1.20	1.19	1.17	1.17	1.16	1.16
Microturbine - CHP											
- Natural gas powered	200	1.04	1.04	1.05	1.05	1.09	1.08	1.06	1.06	1.05	1.05
- On site biogas	200	1.24	1.50	1.24	1.50	1.26	1.52	1.25	1.51	1.24	1.50
- Directed biogas	200	1.12	1.11	1.13	1.13	1.17	1.16	1.14	1.13	1.13	1.12
IC Engine - CHP											
- Natural gas powered (500 kW)	500	1.20	1.19	1.22	1.21	1.26	1.25	1.23	1.22	1.21	1.21
- On site biogas (500 kW)	500	1.82	2.34	1.82	2.36	1.85	2.38	1.83	2.36	1.82	2.35
- Directed biogas (500 kW)	500	1.27	1.26	1.29	1.28	1.33	1.31	1.29	1.28	1.28	1.27
- Natural gas powered (1500 kW)	1,500	1.28	1.27	1.30	1.29	1.34	1.33	1.31	1.30	1.29	1.28
- On site biogas (1500 kW)	1,500	1.50	1.66	1.50	1.68	1.55	1.72	1.51	1.69	1.50	1.68
- Directed biogas (1500 kW)	1,500	1.35	1.35	1.37	1.36	1.42	1.40	1.38	1.37	1.37	1.36
Organic Rankine Cycle											
	500	1.52	1.66	1.53	1.69	1.57	1.72	1.54	1.69	1.53	1.68
Storage											
- Med storage	25	0.43	0.51	0.42	0.50	0.41	0.48	0.42	0.50	0.42	0.50
- Larger storage	1,000	0.46	0.55	0.44	0.53	0.42	0.50	0.44	0.53	0.45	0.54

SGIP Cost Effectiveness Report

TRC Results

**Government/Non-Profit
w/ Actual EPBB Rebate**

Technology	SGIPce System Size (kW)	PG&E		SCE		SDG&E		Statewide - Equal		Statewide - Elec Sales	
		TRC - 2010	TRC - 2016	TRC - 2010	TRC - 2016	TRC - 2010	TRC - 2016	TRC - 2010	TRC - 2016	TRC - 2010	TRC - 2016
Wind Turbine											
- 1 MW	1,000	1.01	1.34	1.03	1.37	1.02	1.35	1.02	1.35	1.02	1.35
Fuel Cell - Electric Only											
- Natural gas	1,200	0.52	0.66	0.53	0.67	0.55	0.69	0.53	0.67	0.53	0.67
- On site biogas	1,200	0.49	0.67	0.50	0.68	0.51	0.70	0.50	0.69	0.50	0.68
- Directed biogas	1,200	0.52	0.66	0.53	0.67	0.55	0.68	0.53	0.67	0.53	0.66
Fuel Cell - CHP (i.e., w/waste heat recovery)											
- Natural gas powered	1,200	0.70	0.85	0.71	0.86	0.73	0.88	0.71	0.86	0.71	0.85
- On site biogas	1,200	0.70	0.93	0.71	0.94	0.73	0.96	0.71	0.94	0.71	0.94
- Directed biogas	1,200	0.70	0.84	0.71	0.85	0.73	0.88	0.71	0.86	0.71	0.85
Gas Turbine - CHP											
- Natural gas powered (1000 kW)	1,000	0.63	0.64	0.64	0.65	0.65	0.67	0.64	0.65	0.63	0.65
- On site biogas (1000 kW)	1,000	0.71	0.76	0.71	0.77	0.73	0.79	0.71	0.77	0.71	0.77
- Directed biogas (1000 kW)	1,000	0.63	0.64	0.64	0.65	0.65	0.67	0.64	0.65	0.63	0.65
- Natural gas powered (3500 kW)	3,500	0.86	0.88	0.87	0.89	0.90	0.91	0.88	0.89	0.87	0.89
- On site biogas (3500 kW)	3,500	1.05	1.12	1.05	1.13	1.08	1.15	1.06	1.13	1.05	1.13
- Directed biogas (3500 kW)	3,500	0.86	0.88	0.87	0.89	0.90	0.91	0.88	0.89	0.87	0.89
Microturbine - CHP											
- Natural gas powered	200	0.84	0.87	0.85	0.88	0.88	0.90	0.86	0.88	0.85	0.88
- On site biogas	200	1.02	1.32	1.02	1.32	1.04	1.34	1.03	1.33	1.02	1.32
- Directed biogas	200	0.84	0.87	0.85	0.88	0.88	0.90	0.86	0.88	0.85	0.87
IC Engine - CHP											
- Natural gas powered (500 kW)	500	0.99	1.01	1.00	1.03	1.04	1.05	1.01	1.03	1.00	1.02
- On site biogas (500 kW)	500	1.65	2.26	1.66	2.27	1.69	2.30	1.67	2.28	1.66	2.27
- Directed biogas (500 kW)	500	0.99	1.01	1.00	1.03	1.04	1.05	1.01	1.03	1.00	1.02
- Natural gas powered (1500 kW)	1,500	1.07	1.09	1.09	1.11	1.12	1.13	1.10	1.11	1.09	1.10
- On site biogas (1500 kW)	1,500	1.44	1.68	1.45	1.71	1.49	1.74	1.46	1.71	1.45	1.70
- Directed biogas (1500 kW)	1,500	1.07	1.09	1.09	1.11	1.12	1.13	1.10	1.11	1.09	1.10
Organic Rankine Cycle											
	500	1.24	1.43	1.25	1.46	1.30	1.50	1.27	1.47	1.25	1.45
Storage											
- Med storage	25	0.19	0.26	0.19	0.26	0.20	0.27	0.19	0.26	0.19	0.26
- Larger storage	1,000	0.22	0.30	0.22	0.30	0.23	0.30	0.22	0.30	0.22	0.30

SGIP Cost Effectiveness Report
TRC Results
Residential
w/ Actual EPBB Rebate

Technology	SGIPce System Size (kW)	PG&E		SCE		SDG&E		Statewide - Equal		Statewide - Elec Sales	
		TRC - 2010	TRC - 2016	TRC - 2010	TRC - 2016	TRC - 2010	TRC - 2016	TRC - 2010	TRC - 2016	TRC - 2010	TRC - 2016
Wind Turbine											
- 10 kW	10	0.44	0.58	0.45	0.59	0.44	0.58	0.44	0.58	0.44	0.58
Fuel Cell - Electric Only											
- Natural gas powered	5	0.69	0.91	0.70	0.92	0.71	0.93	0.70	0.92	0.70	0.92
Storage											
- Med storage	25	0.20	0.27	0.20	0.27	0.21	0.28	0.21	0.27	0.21	0.27

SGIP Cost Effectiveness Report
Societal TRC Test Results

Societal TRC Test Results: MT200kW

Inland · Non Residential

		2010	2016
PG&E	Direct Bio-Gas	113%	114%
	Natural Gas	105%	106%
	Onsite Bio-Gas	124%	152%
SCE	Direct Bio-Gas	114%	115%
	Natural Gas	106%	107%
	Onsite Bio-Gas	124%	152%
SDG&E	Direct Bio-Gas	115%	117%
	Natural Gas	107%	108%
	Onsite Bio-Gas	125%	153%

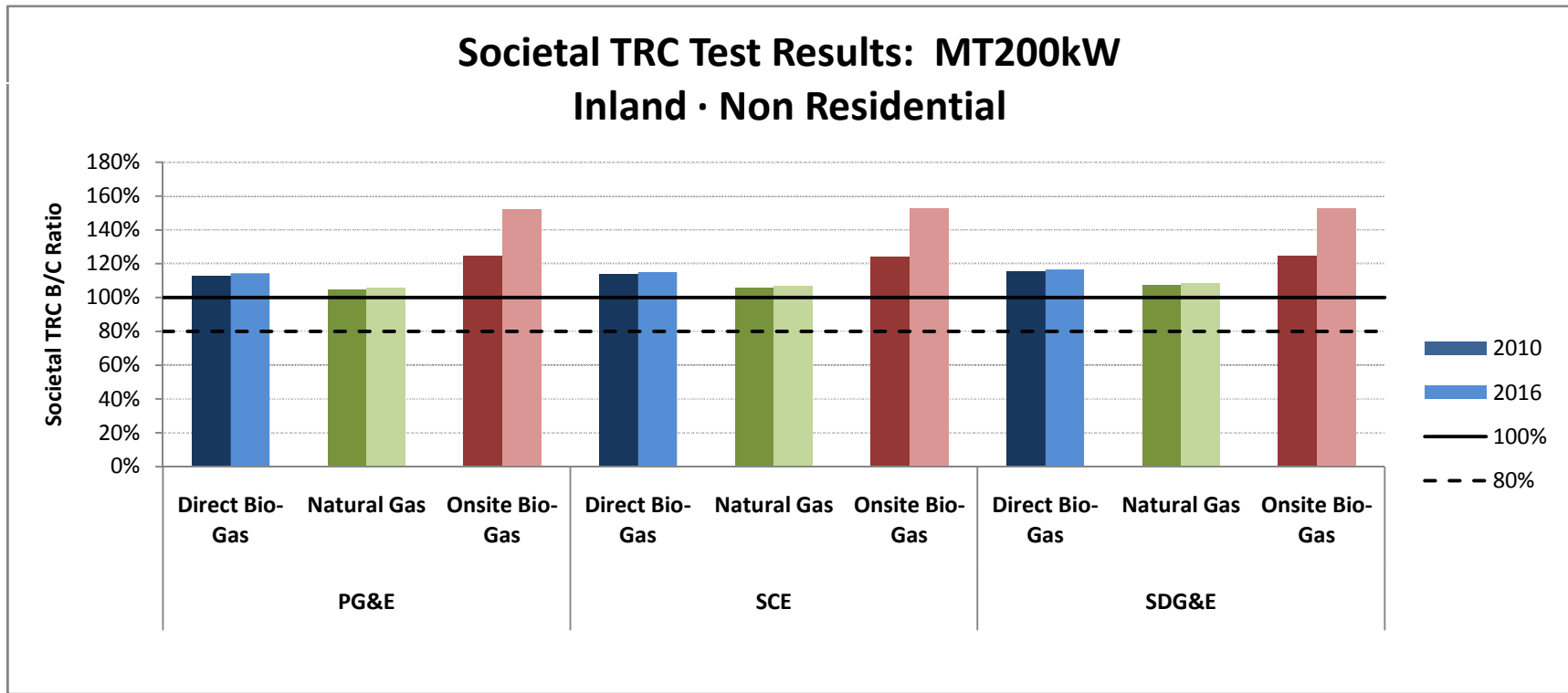

SGIP Cost Effectiveness Report
Societal TRC Test Results

Societal TRC Test Results: MT200kW

Inland · Government

		2010	2016
PG&E	Direct Bio-Gas	85%	88%
	Natural Gas	85%	88%
	Onsite Bio-Gas	102%	133%
SCE	Direct Bio-Gas	86%	88%
	Natural Gas	86%	88%
	Onsite Bio-Gas	102%	133%
SDG&E	Direct Bio-Gas	86%	89%
	Natural Gas	86%	89%
	Onsite Bio-Gas	102%	

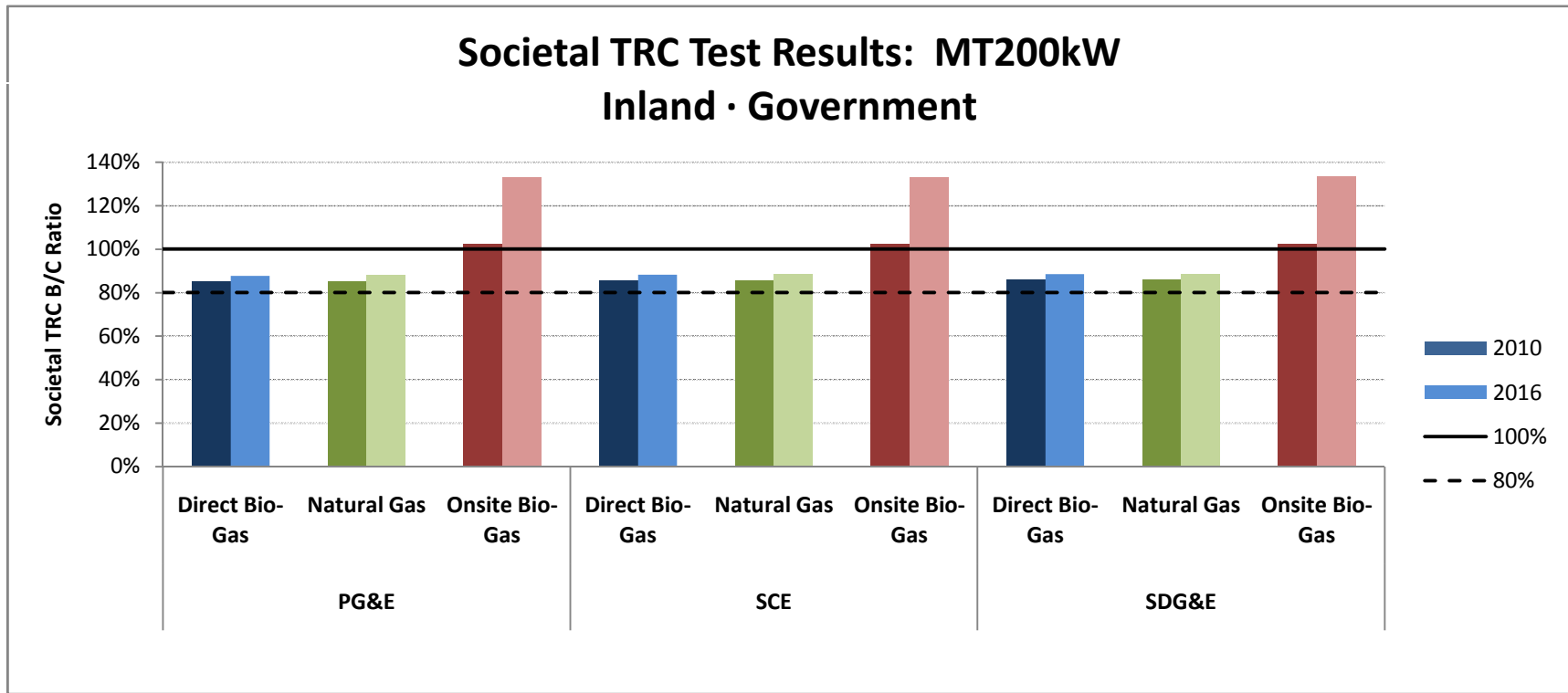

SGIP Cost Effectiveness Report
Societal TRC Test Results

Societal TRC Test Results: ICE500kW

Inland · Non Residential

		2010	2016
PG&E	Direct Bio-Gas	128%	129%
	Natural Gas	121%	122%
	Onsite Bio-Gas	182%	239%
SCE	Direct Bio-Gas	129%	131%
	Natural Gas	122%	123%
	Onsite Bio-Gas	182%	239%
SDG&E	Direct Bio-Gas	131%	132%
	Natural Gas	124%	124%
	Onsite Bio-Gas	182%	240%

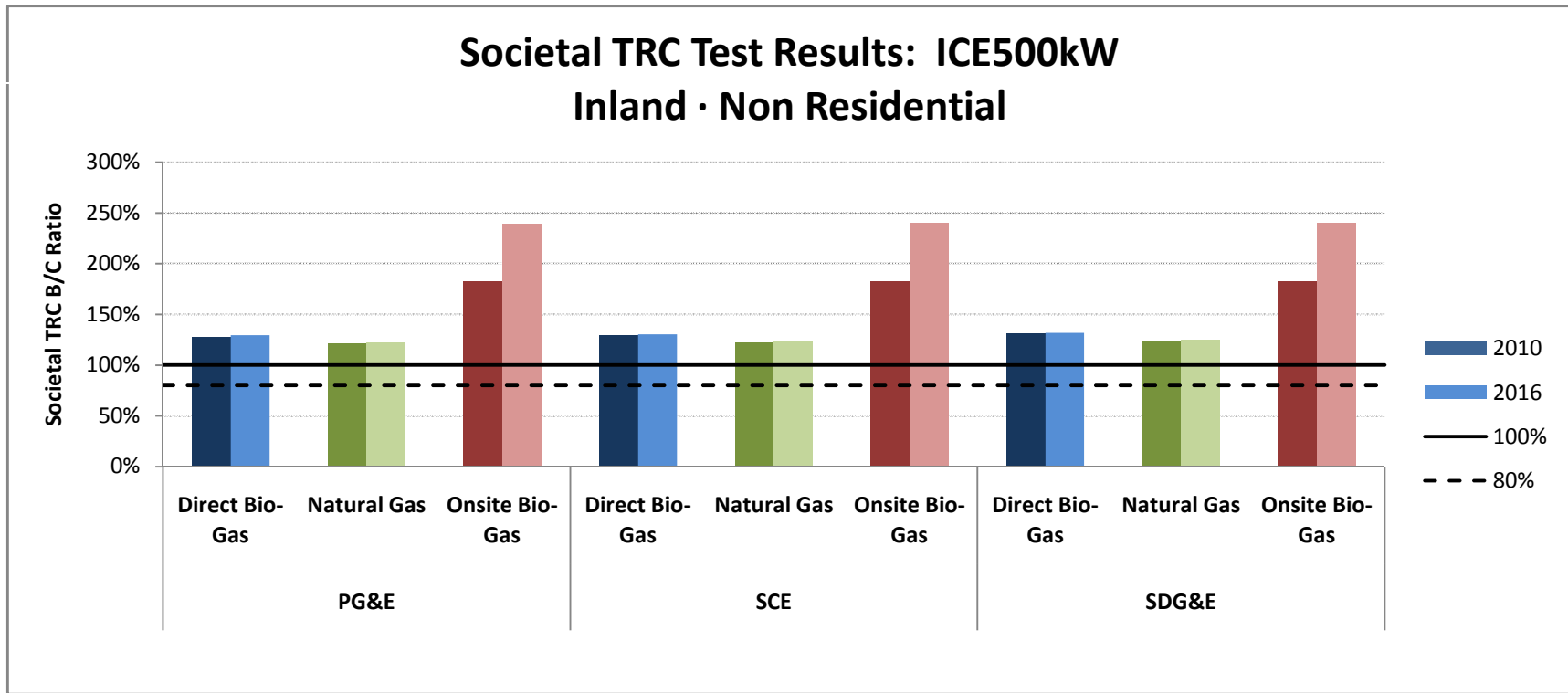

SGIP Cost Effectiveness Report
Societal TRC Test Results

Societal TRC Test Results: ICE500kW

Inland · Government

		2010	2016
PG&E	Direct Bio-Gas	100%	103%
	Natural Gas	100%	103%
	Onsite Bio-Gas	166%	229%
SCE	Direct Bio-Gas	101%	104%
	Natural Gas	101%	104%
	Onsite Bio-Gas	166%	229%
SDG&E	Direct Bio-Gas	101%	104%
	Natural Gas	101%	104%
	Onsite Bio-Gas	166%	230%

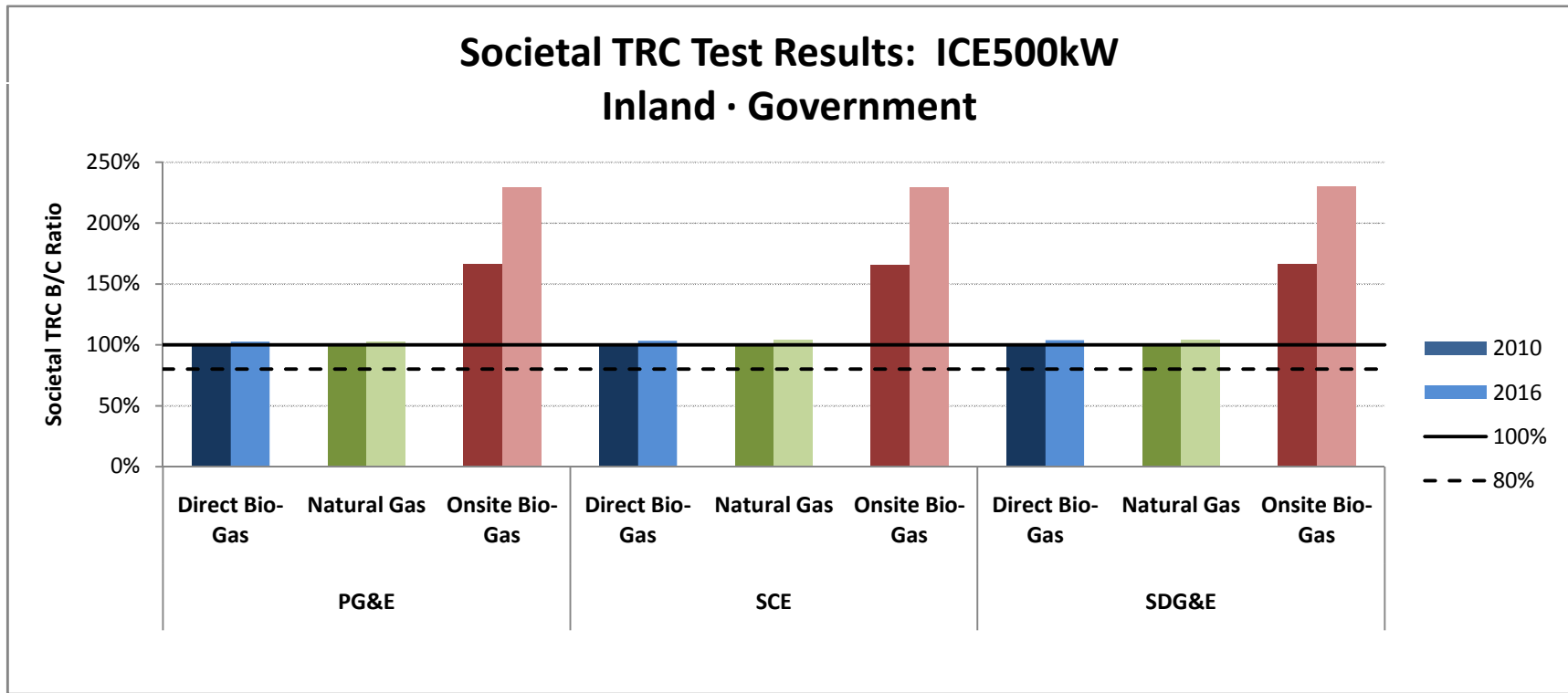

SGIP Cost Effectiveness Report
Societal TRC Test Results

Societal TRC Test Results: ICE1500kW

Inland · Non Residential

		2010	2016
PG&E	Direct Bio-Gas	136%	138%
	Natural Gas	129%	129%
	Onsite Bio-Gas	151%	172%
SCE	Direct Bio-Gas	138%	139%
	Natural Gas	130%	131%
	Onsite Bio-Gas	151%	172%
SDG&E	Direct Bio-Gas	139%	140%
	Natural Gas	132%	132%
	Onsite Bio-Gas	151%	173%

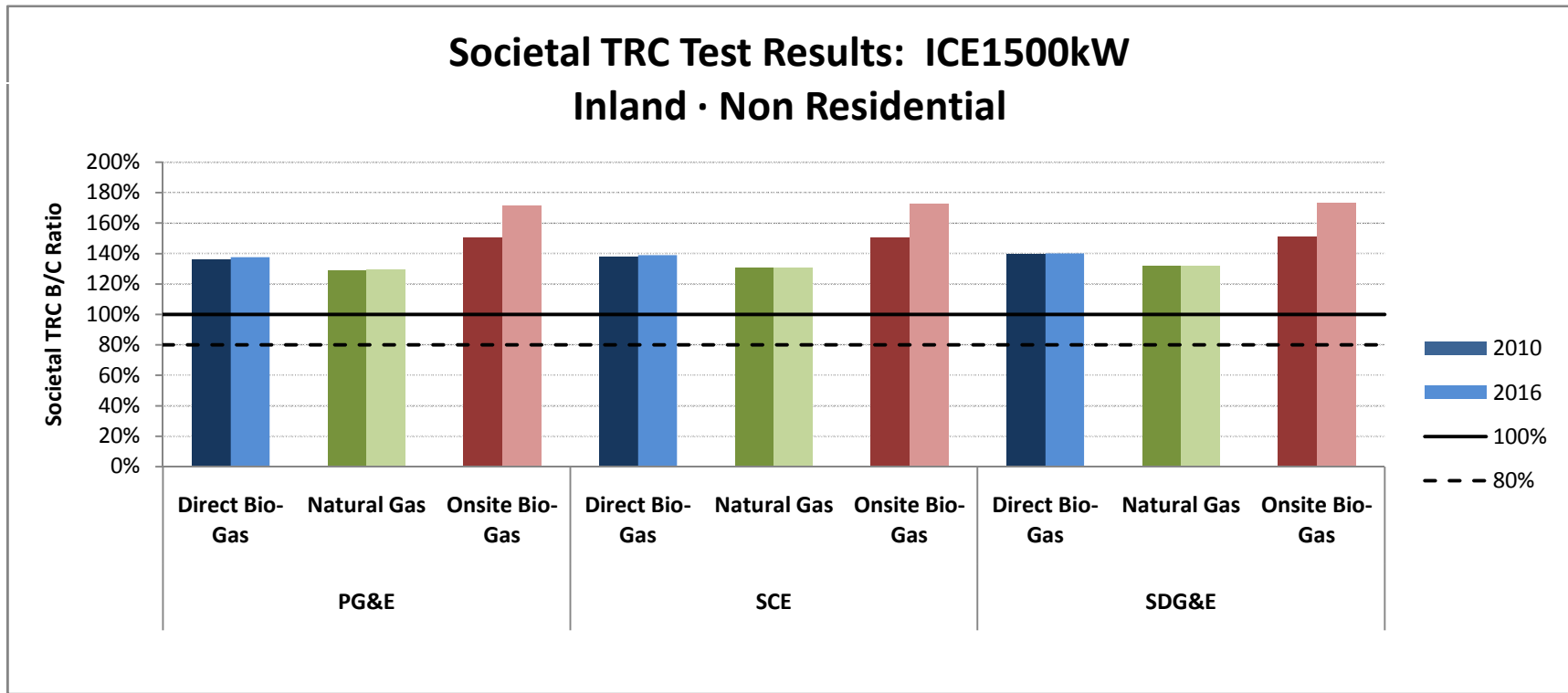

SGIP Cost Effectiveness Report
Societal TRC Test Results

Societal TRC Test Results: ICE1500kW

Inland · Government

		2010	2016
PG&E	Direct Bio-Gas	108%	111%
	Natural Gas	108%	111%
	Onsite Bio-Gas	146%	172%
SCE	Direct Bio-Gas	109%	111%
	Natural Gas	109%	111%
	Onsite Bio-Gas	145%	173%
SDG&E	Direct Bio-Gas	110%	112%
	Natural Gas	110%	112%
	Onsite Bio-Gas	146%	173%

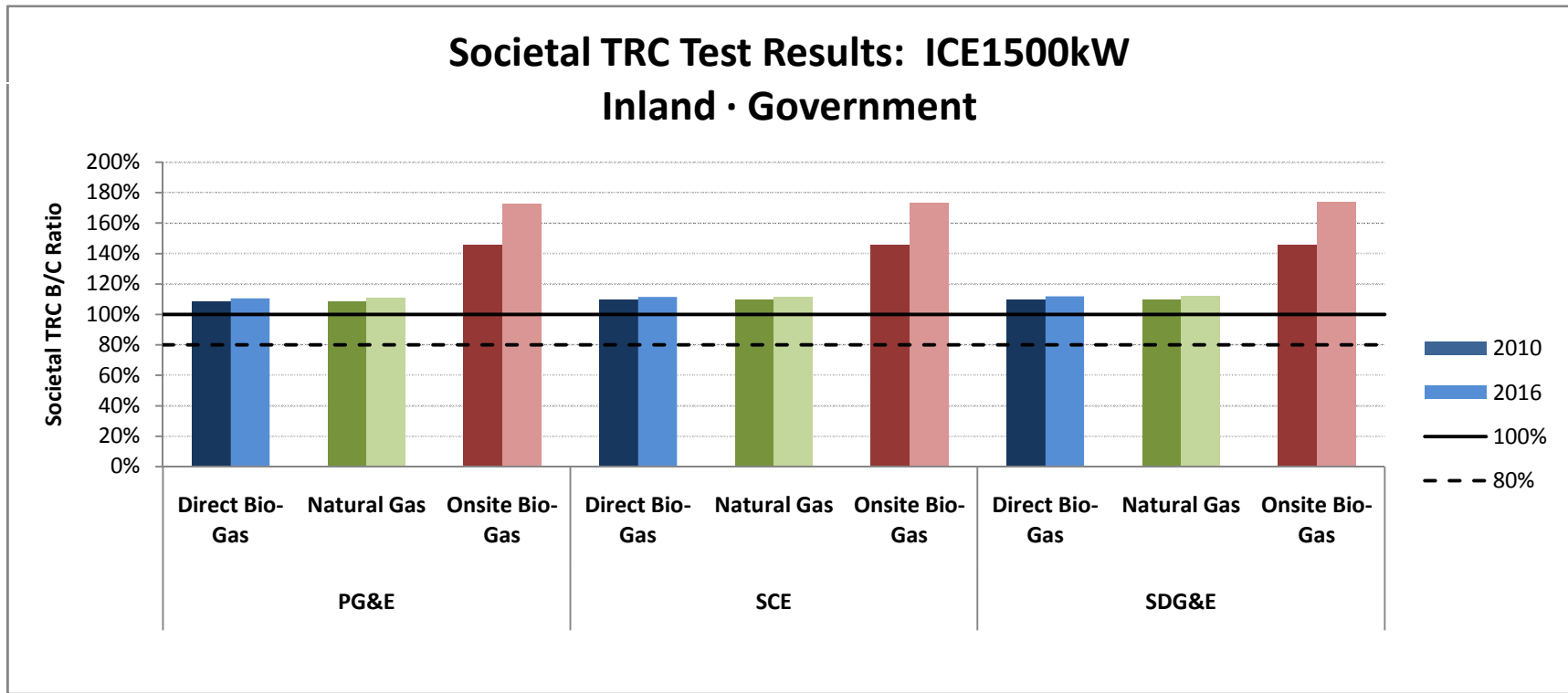

SGIP Cost Effectiveness Report
Societal TRC Test Results

Societal TRC Test Results: GTIe2MW

Inland · Non Residential

		2010	2016
PG&E	Direct Bio-Gas	95%	95%
	Natural Gas	88%	88%
	Onsite Bio-Gas	89%	92%
SCE	Direct Bio-Gas	96%	96%
	Natural Gas	88%	88%
	Onsite Bio-Gas	89%	93%
SDG&E	Direct Bio-Gas	97%	97%
	Natural Gas	89%	89%
	Onsite Bio-Gas	89%	93%

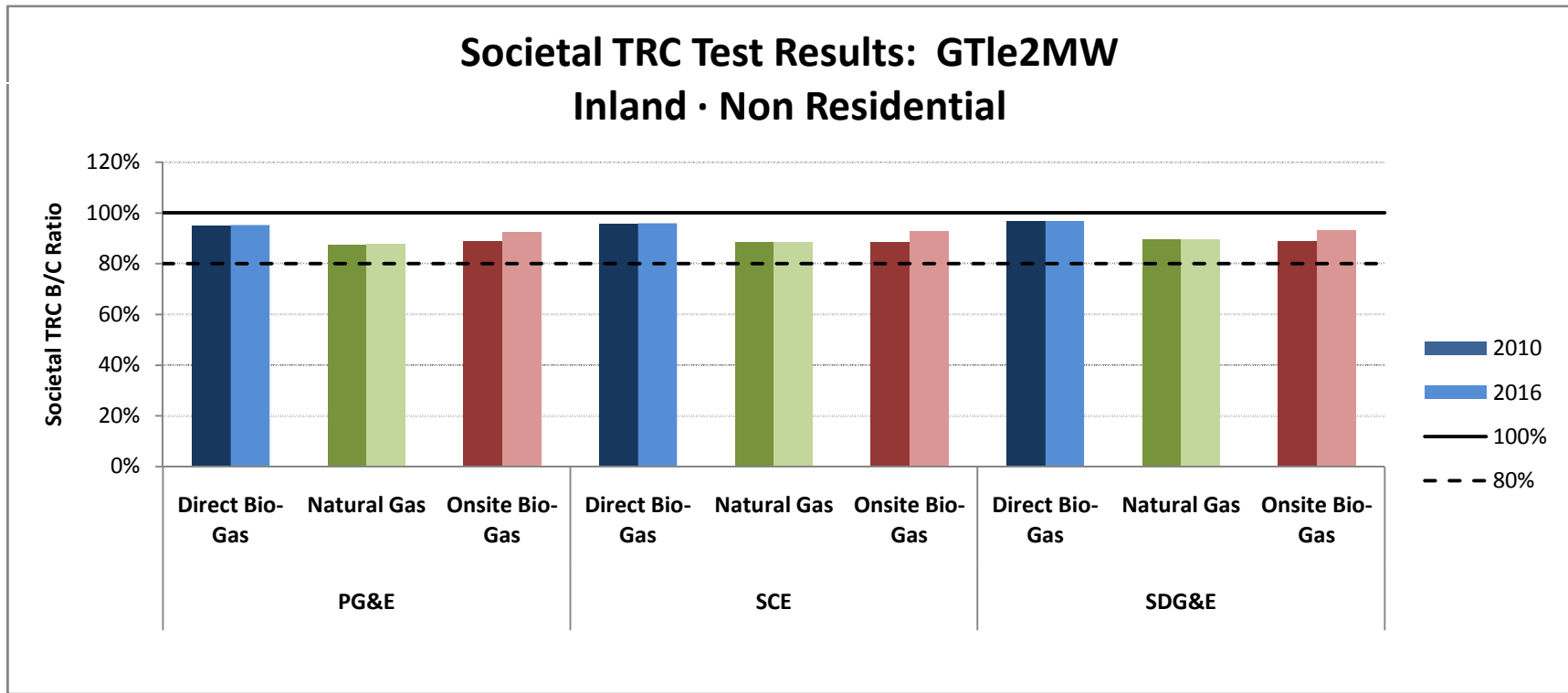

SGIP Cost Effectiveness Report
Societal TRC Test Results

Societal TRC Test Results: GTIe2MW

Inland · Government

		2010	2016
PG&E	Direct Bio-Gas	63%	65%
	Natural Gas	63%	65%
	Onsite Bio-Gas	71%	77%
SCE	Direct Bio-Gas	64%	65%
	Natural Gas	64%	65%
	Onsite Bio-Gas	71%	78%
SDG&E	Direct Bio-Gas	64%	66%
	Natural Gas	64%	66%
	Onsite Bio-Gas	71%	78%

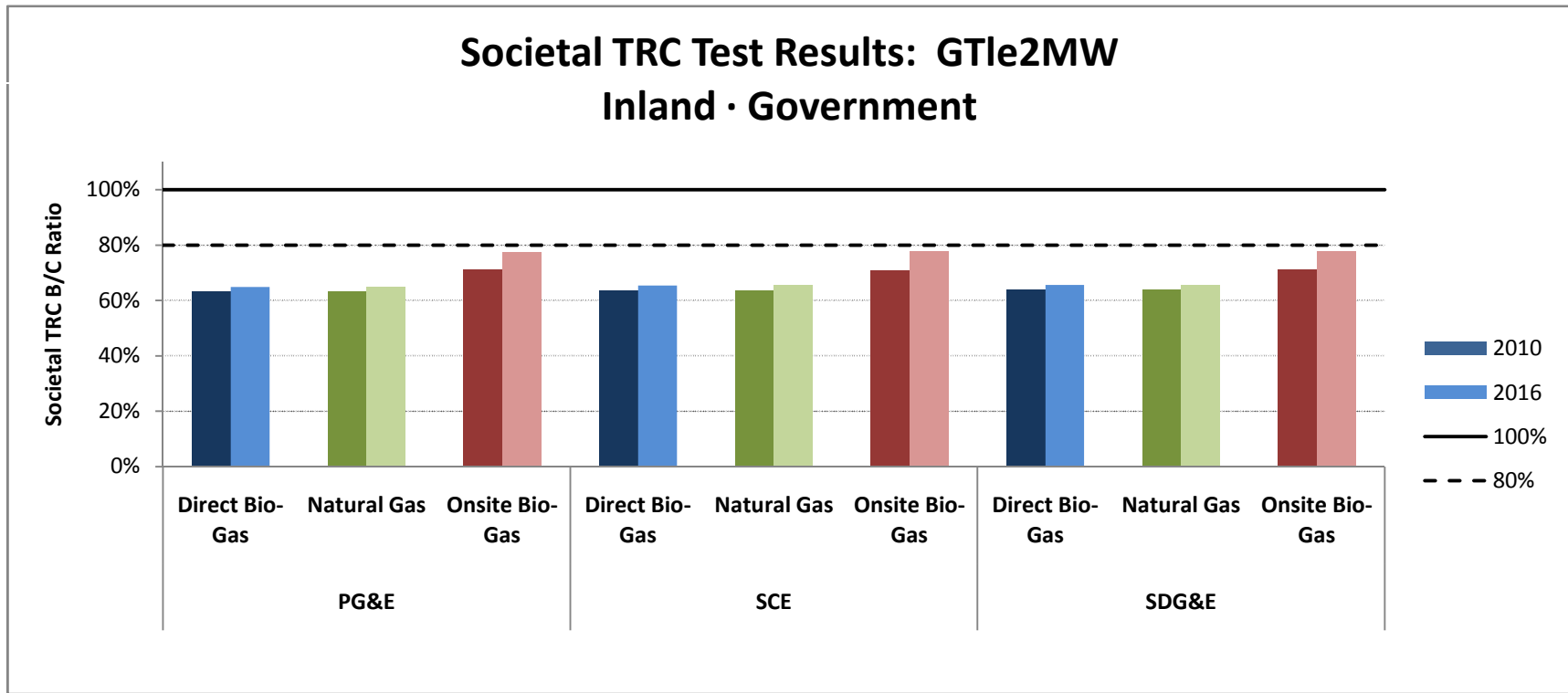

SGIP Cost Effectiveness Report
Societal TRC Test Results

Societal TRC Test Results: GTg2to5MW

Inland · Non Residential

		2010	2016
PG&E	Direct Bio-Gas	116%	116%
	Natural Gas	109%	109%
	Onsite Bio-Gas	117%	123%
SCE	Direct Bio-Gas	117%	117%
	Natural Gas	110%	110%
	Onsite Bio-Gas	117%	123%
SDG&E	Direct Bio-Gas	118%	118%
	Natural Gas	111%	111%
	Onsite Bio-Gas	117%	123%

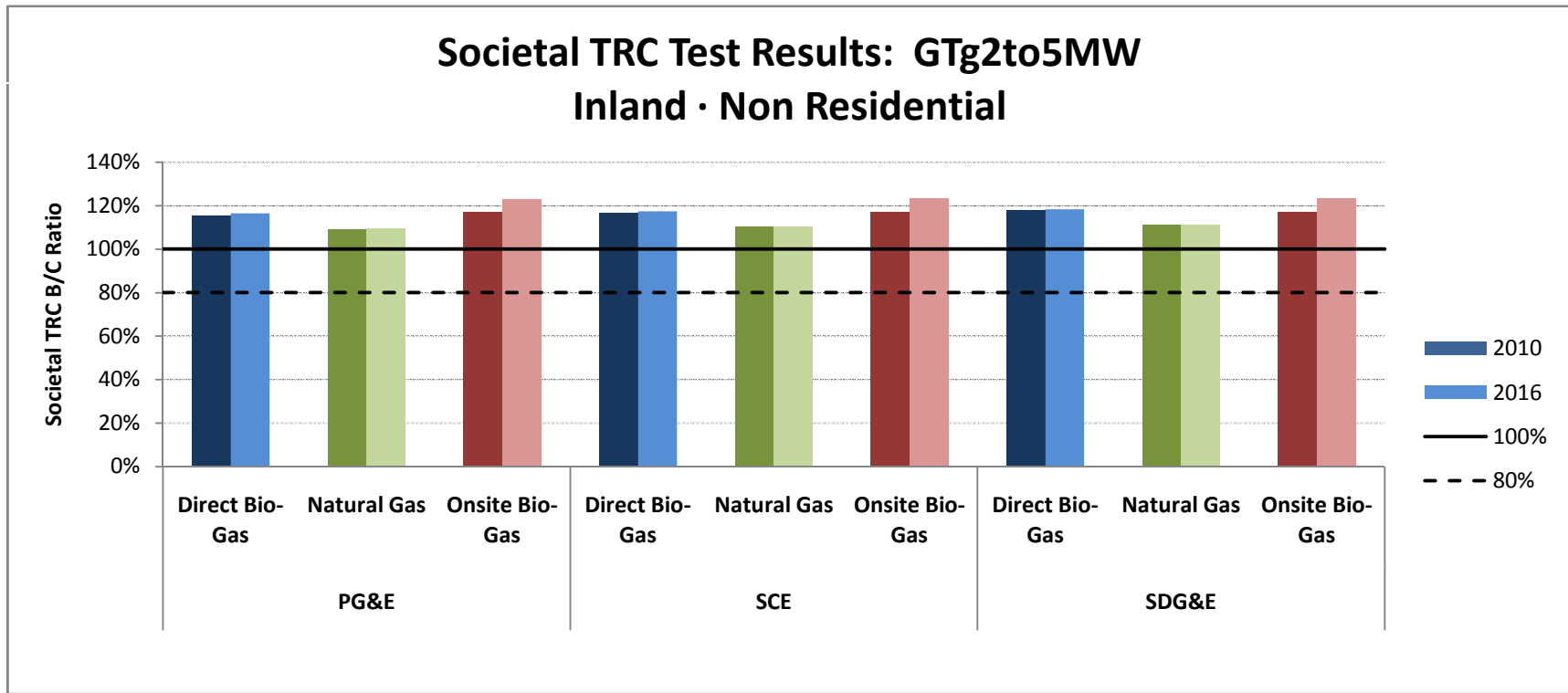

SGIP Cost Effectiveness Report
Societal TRC Test Results

Societal TRC Test Results: GTg2to5MW

Inland · Government

		2010	2016
PG&E	Direct Bio-Gas	87%	89%
	Natural Gas	87%	89%
	Onsite Bio-Gas	105%	113%
SCE	Direct Bio-Gas	87%	89%
	Natural Gas	87%	89%
	Onsite Bio-Gas	105%	114%
SDG&E	Direct Bio-Gas	88%	89%
	Natural Gas	88%	89%
	Onsite Bio-Gas	105%	114%

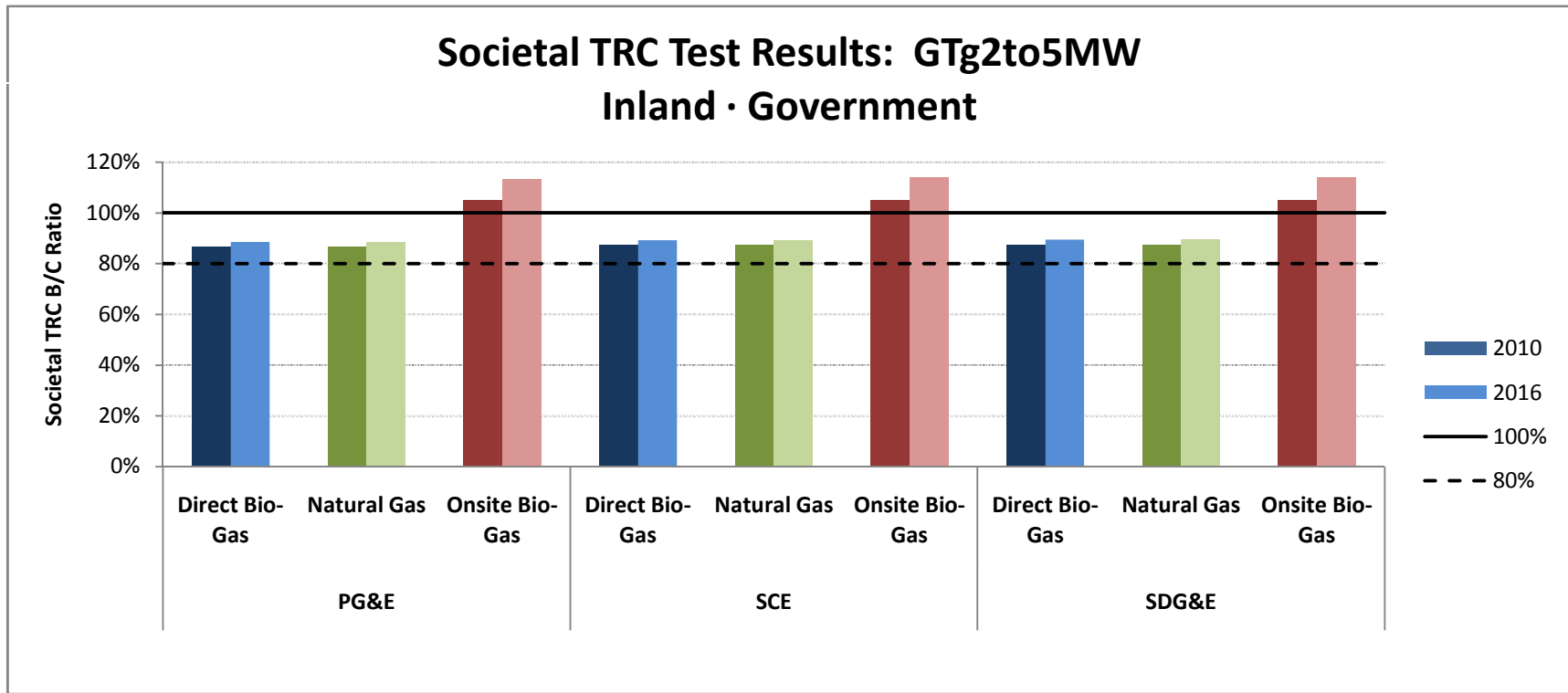

SGIP Cost Effectiveness Report
Societal TRC Test Results

Societal TRC Test Results: FC5kW

Inland · Residential

		2010	2016
PG&E	Direct Bio-Gas	N/A	N/A
	Natural Gas	73%	95%
	Onsite Bio-Gas	N/A	N/A
SCE	Direct Bio-Gas	N/A	N/A
	Natural Gas	74%	97%
	Onsite Bio-Gas	N/A	N/A
SDG&E	Direct Bio-Gas	N/A	N/A
	Natural Gas	74%	96%
	Onsite Bio-Gas	N/A	N/A

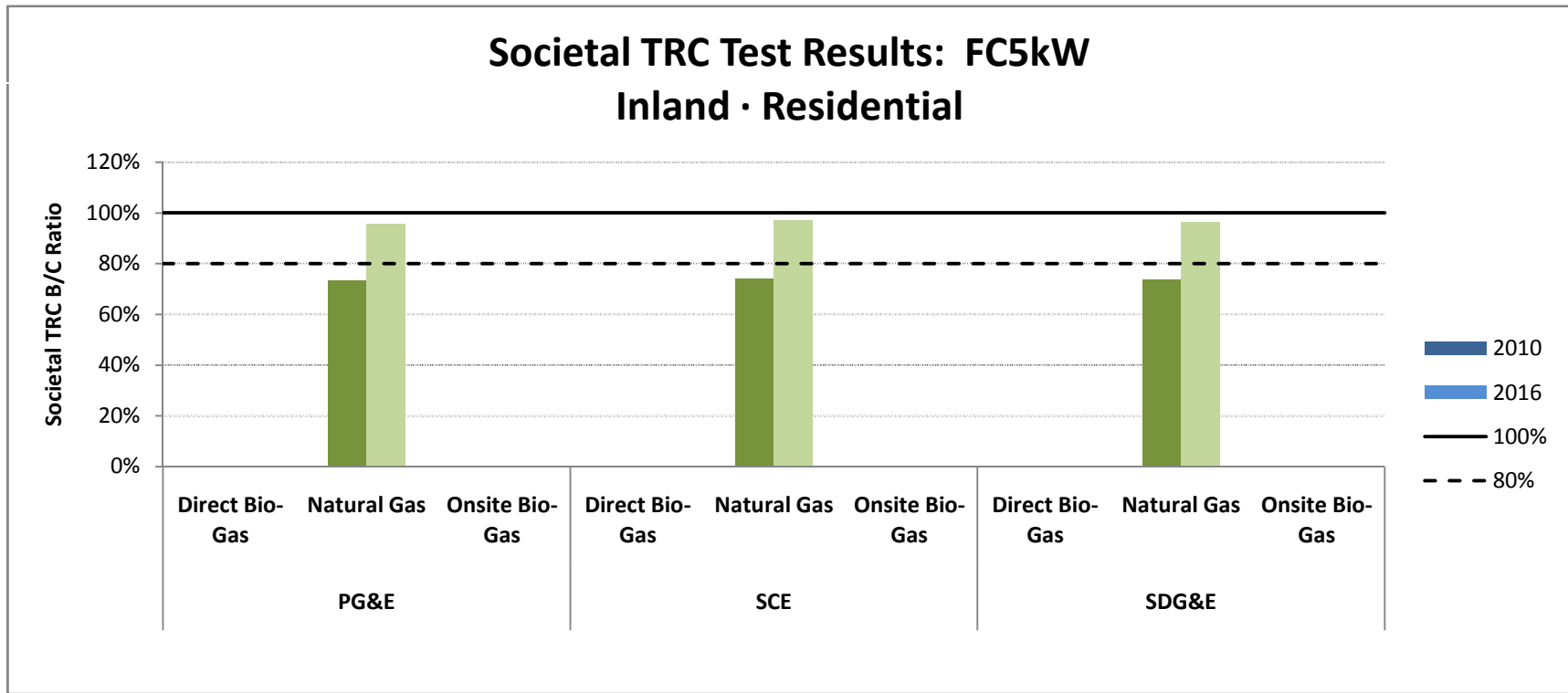

SGIP Cost Effectiveness Report
Societal TRC Test Results

Societal TRC Test Results: FC1200kWe

Inland · Non Residential

		2010	2016
PG&E	Direct Bio-Gas	93%	104%
	Natural Gas	91%	101%
	Onsite Bio-Gas	87%	100%
SCE	Direct Bio-Gas	94%	105%
	Natural Gas	92%	101%
	Onsite Bio-Gas	87%	101%
SDG&E	Direct Bio-Gas	94%	105%
	Natural Gas	92%	102%
	Onsite Bio-Gas	87%	101%

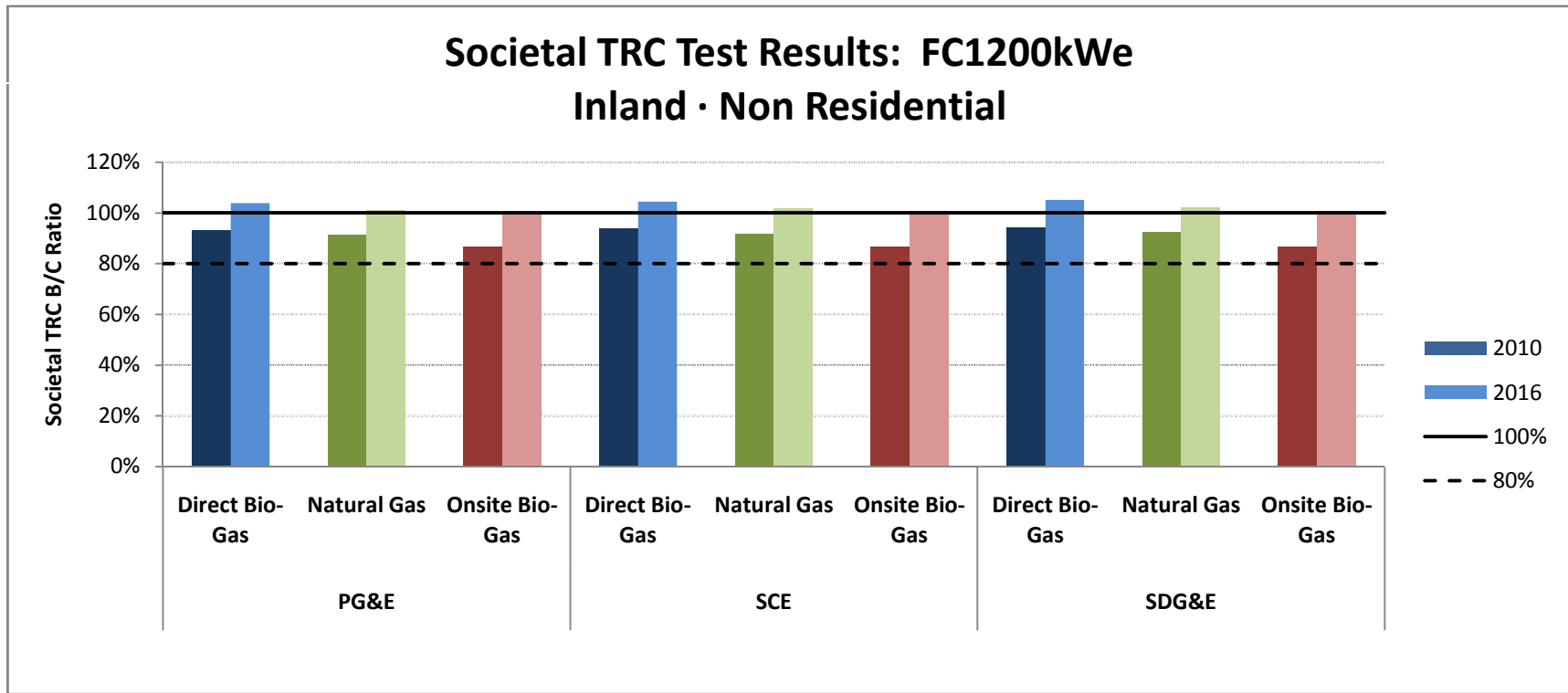

SGIP Cost Effectiveness Report
Societal TRC Test Results

Societal TRC Test Results: FC1200kWe

Inland · Government

		2010	2016
PG&E	Direct Bio-Gas	53%	67%
	Natural Gas	53%	67%
	Onsite Bio-Gas	50%	69%
SCE	Direct Bio-Gas	54%	67%
	Natural Gas	54%	67%
	Onsite Bio-Gas	50%	69%
SDG&E	Direct Bio-Gas	54%	68%
	Natural Gas	54%	68%
	Onsite Bio-Gas	51%	69%

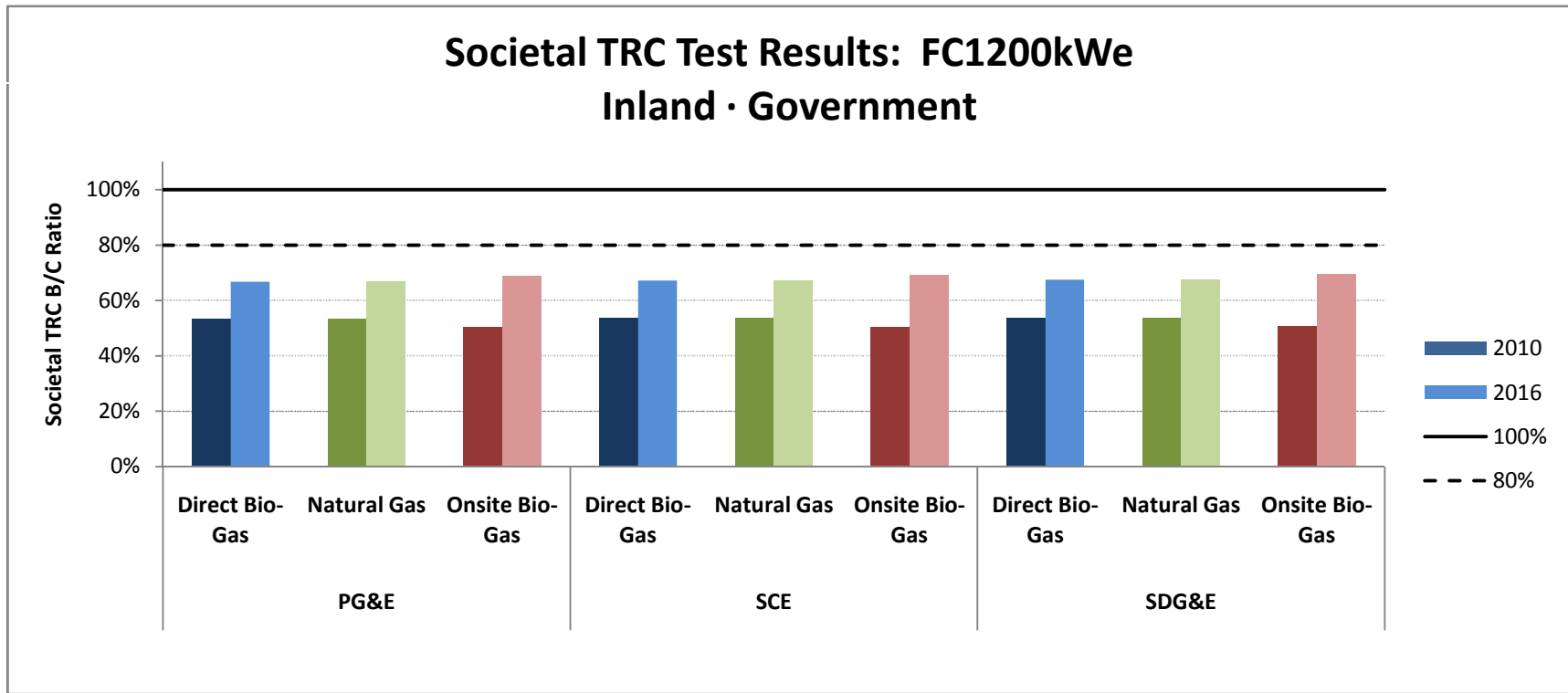

SGIP Cost Effectiveness Report
Societal TRC Test Results

Societal TRC Test Results: FC1200kW

Inland · Non Residential

		2010	2016
PG&E	Direct Bio-Gas	107%	118%
	Natural Gas	104%	114%
	Onsite Bio-Gas	101%	119%
SCE	Direct Bio-Gas	107%	119%
	Natural Gas	104%	115%
	Onsite Bio-Gas	101%	119%
SDG&E	Direct Bio-Gas	108%	120%
	Natural Gas	105%	116%
	Onsite Bio-Gas	101%	120%

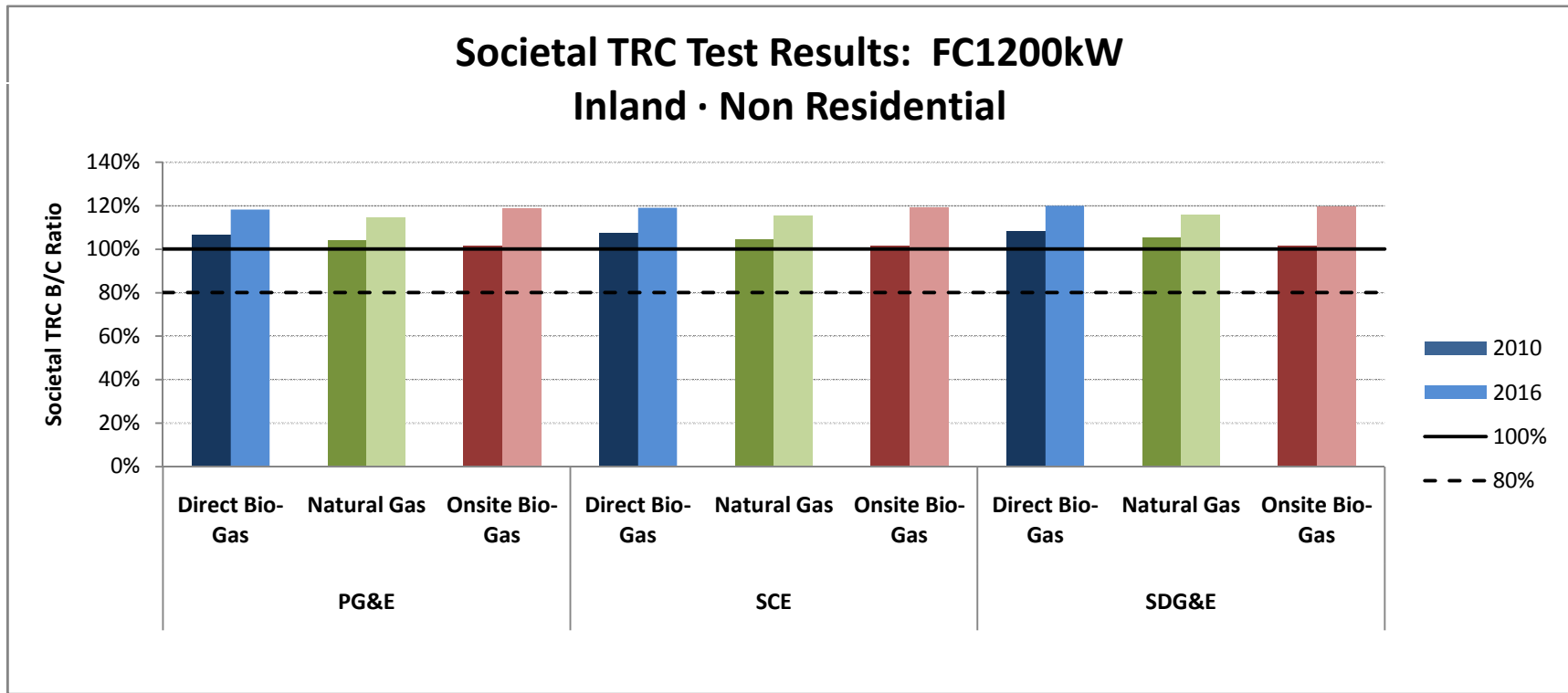

SGIP Cost Effectiveness Report
Societal TRC Test Results

Societal TRC Test Results: FC1200kW

Inland · Government

		2010	2016
PG&E	Direct Bio-Gas	71%	86%
	Natural Gas	71%	86%
	Onsite Bio-Gas	72%	95%
SCE	Direct Bio-Gas	72%	86%
	Natural Gas	72%	86%
	Onsite Bio-Gas	72%	95%
SDG&E	Direct Bio-Gas	72%	87%
	Natural Gas	72%	87%
	Onsite Bio-Gas	72%	96%

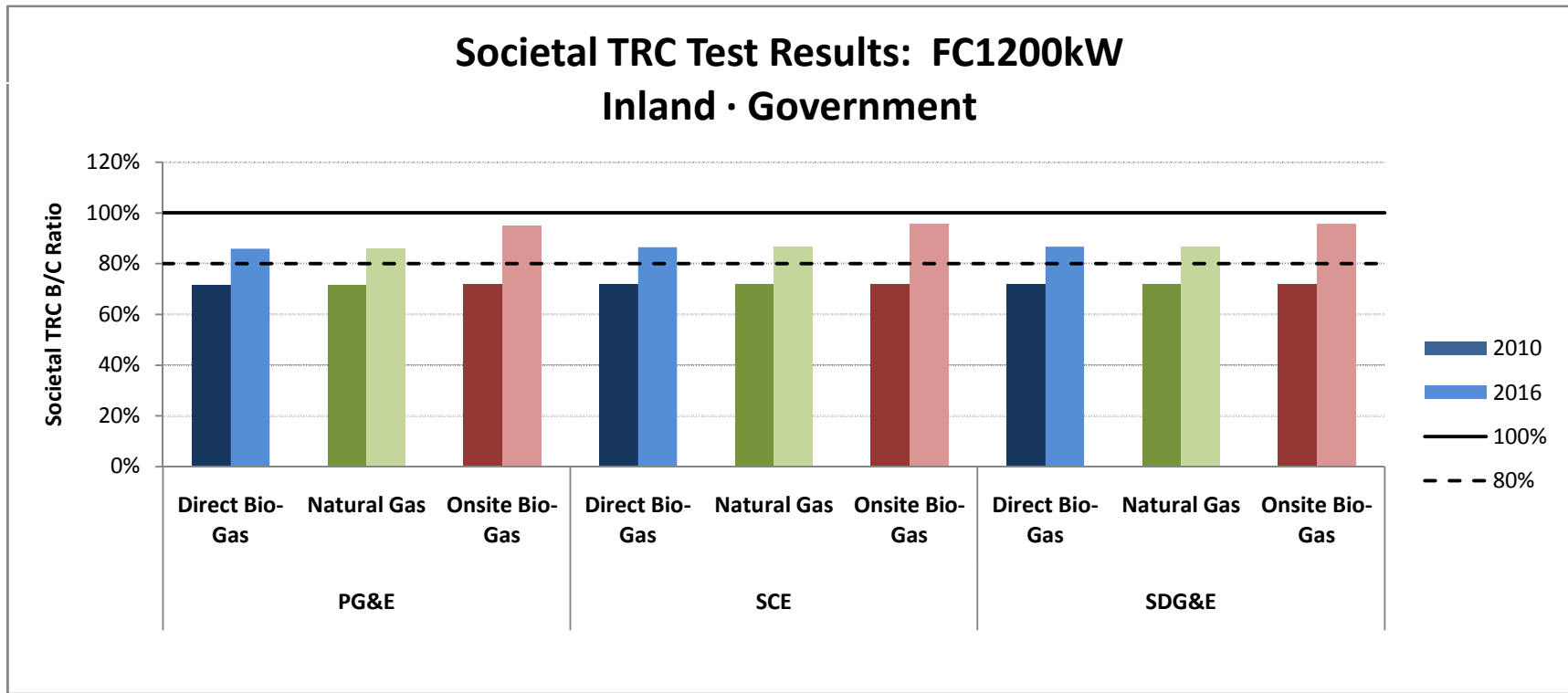

SGIP Cost Effectiveness Report
Societal TRC Test Results

Societal TRC Test Results: ORC500kW

Inland · Commercial

	2010	2016
PG&E	153%	172%
SCE	153%	173%
SDG&E	153%	174%

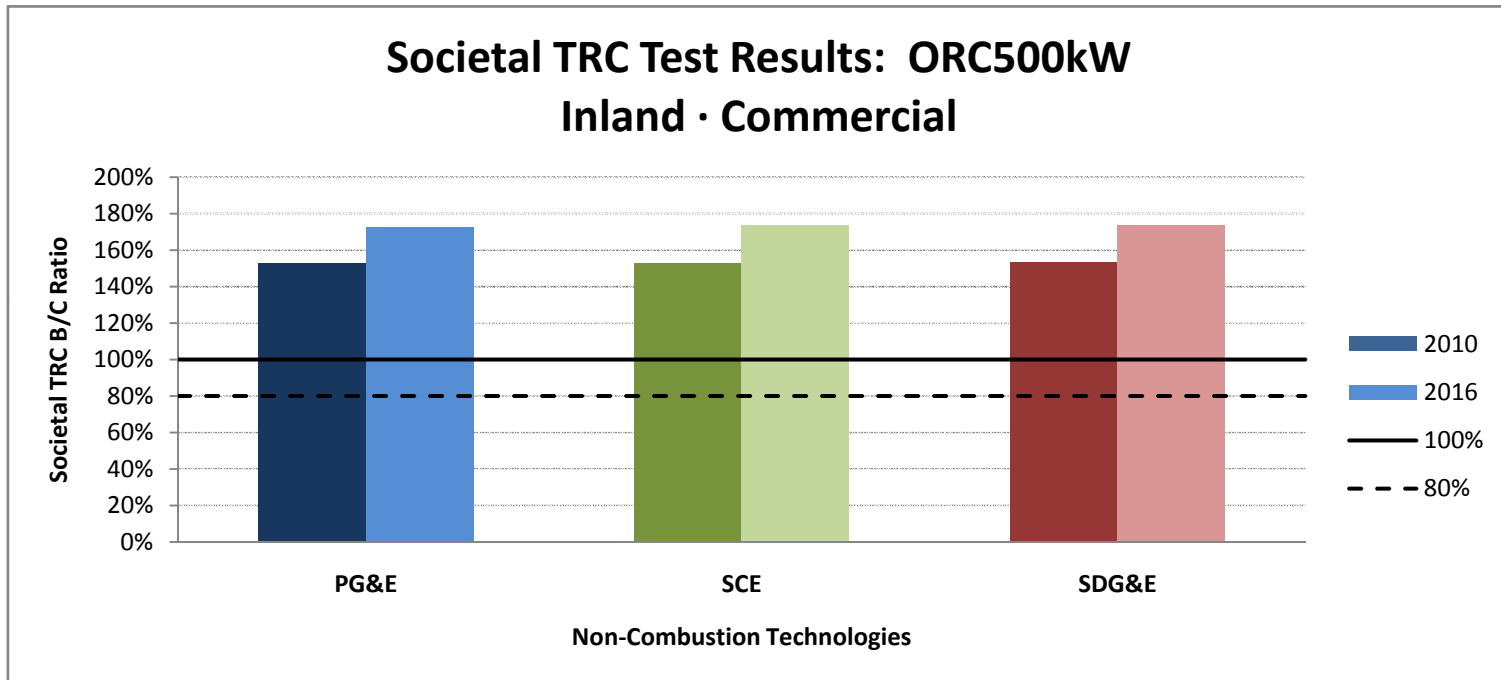

SGIP Cost Effectiveness Report
Societal TRC Test Results

Societal TRC Test Results: ORC500kW

Inland · Government

	2010	2016
PG&E	125%	147%
SCE	126%	148%
SDG&E	126%	148%

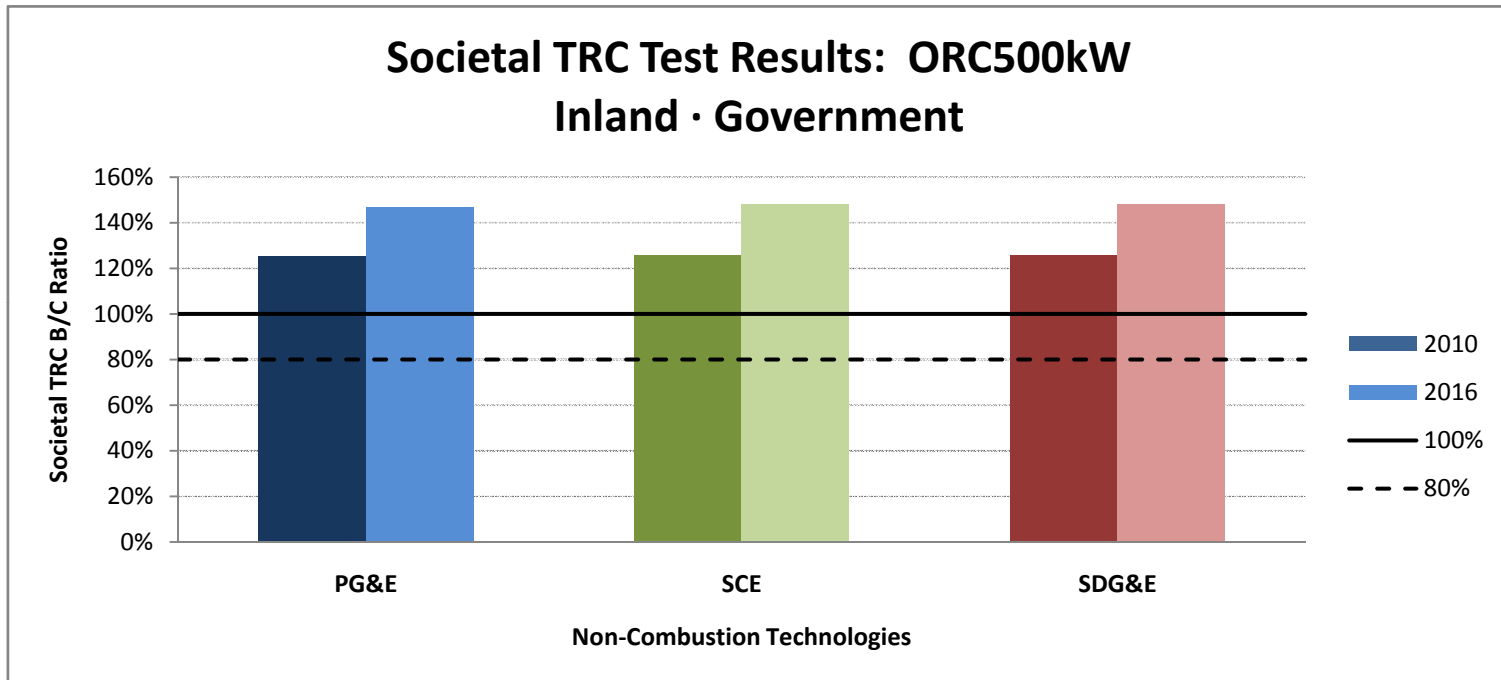

SGIP Cost Effectiveness Report
Societal TRC Test Results

Societal TRC Test Results: Storage1MW

Inland · Commercial

	2010	2016
PG&E	58%	69%
SCE	57%	67%
SDG&E	53%	63%

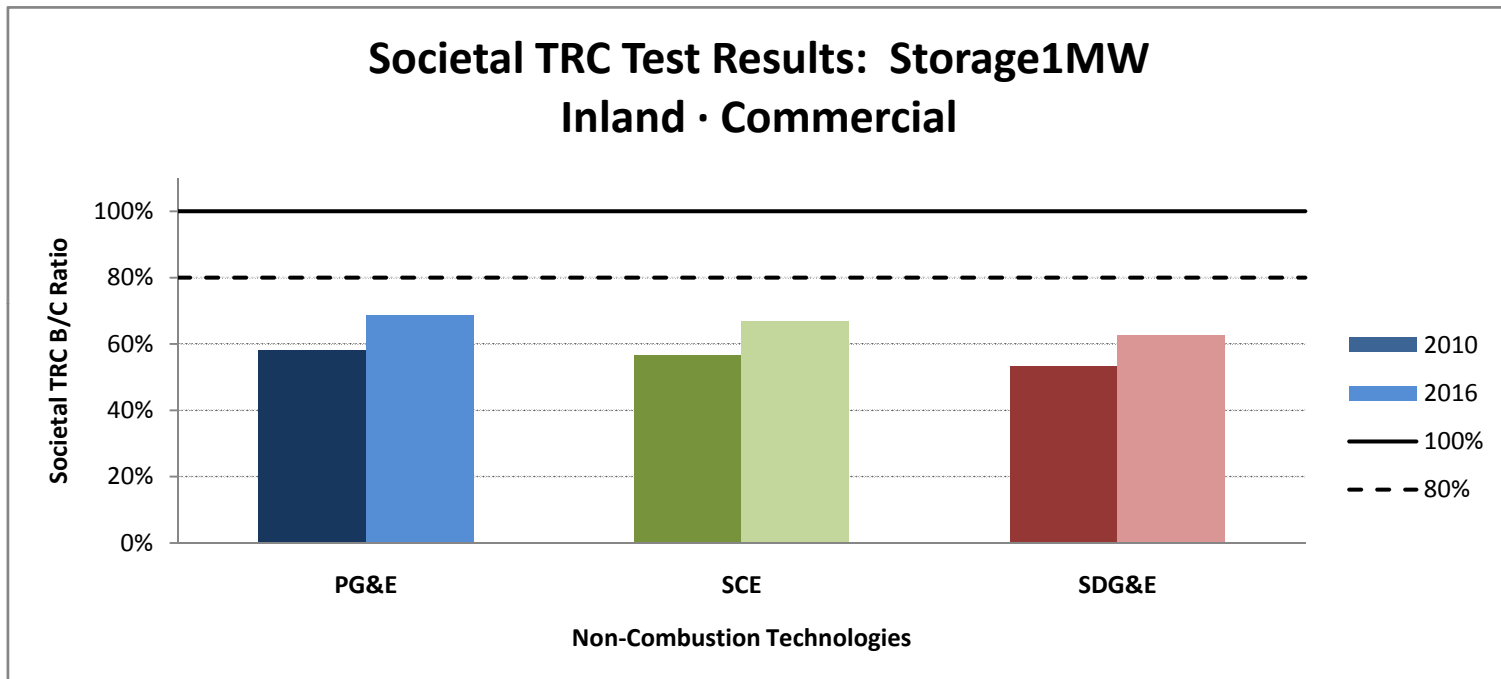

SGIP Cost Effectiveness Report
Societal TRC Test Results

Societal TRC Test Results: Storage1MW

Inland · Government

	2010	2016
PG&E	23%	31%
SCE	23%	32%
SDG&E	23%	32%

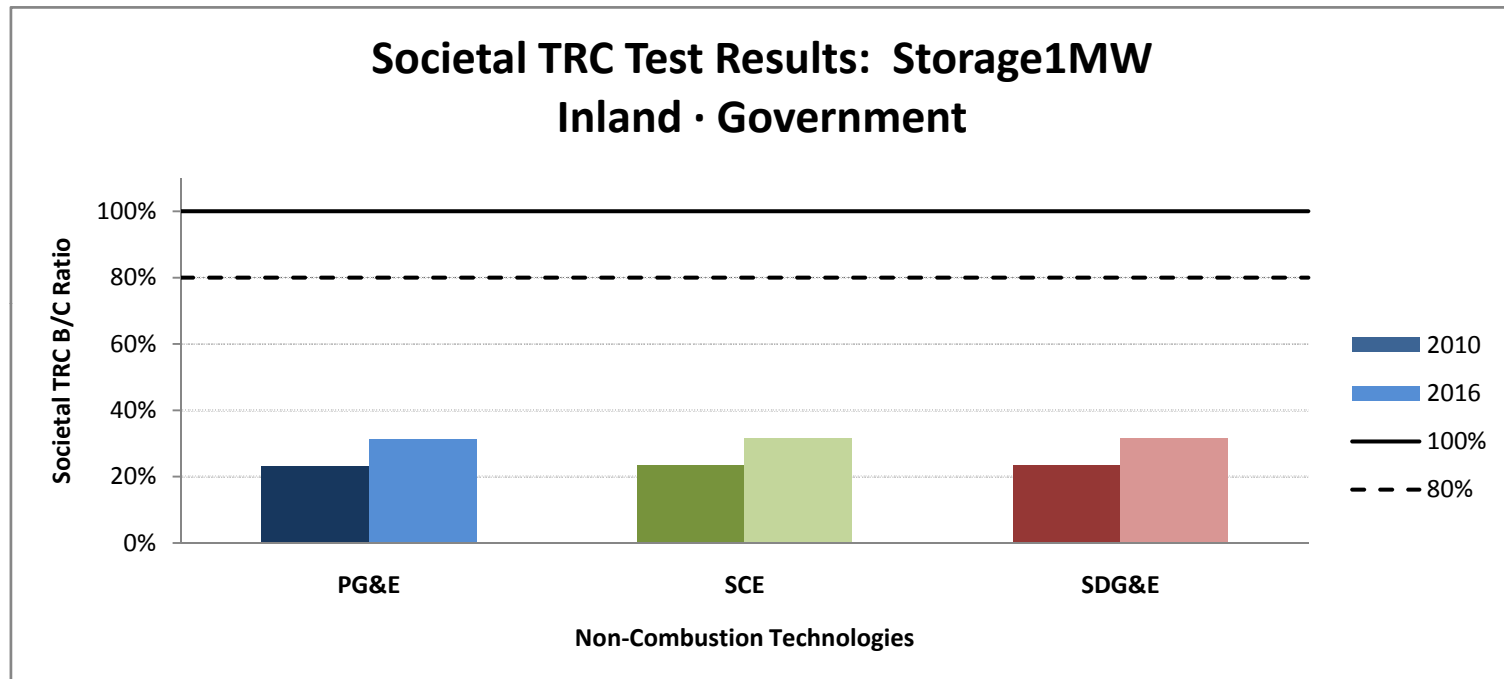

SGIP Cost Effectiveness Report
Societal TRC Test Results

Societal TRC Test Results: Storage25kW

Inland · Commercial

	2010	2016
PG&E	50%	59%
SCE	50%	58%
SDG&E	48%	55%

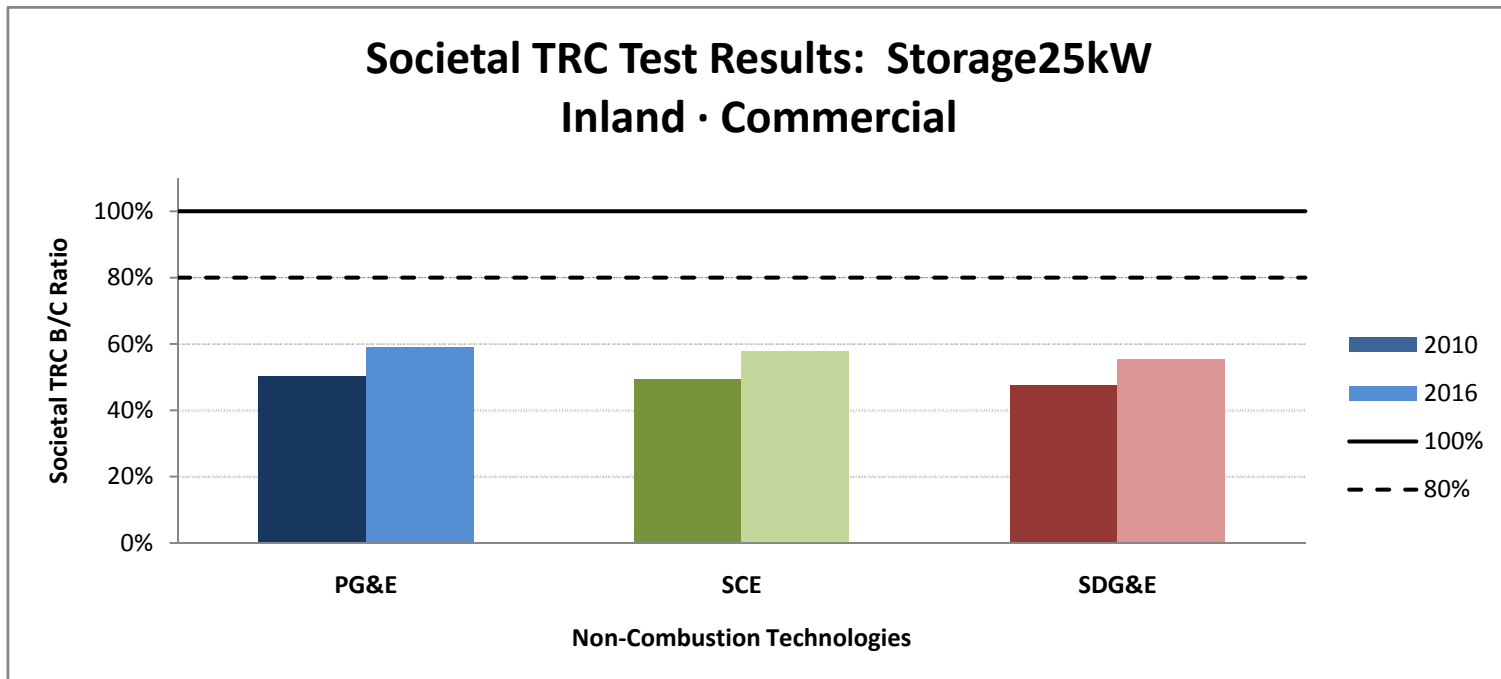

SGIP Cost Effectiveness Report
Societal TRC Test Results

Societal TRC Test Results: Storage25kW

Inland · Government

	2010	2016
PG&E	19%	26%
SCE	19%	26%
SDG&E	19%	26%

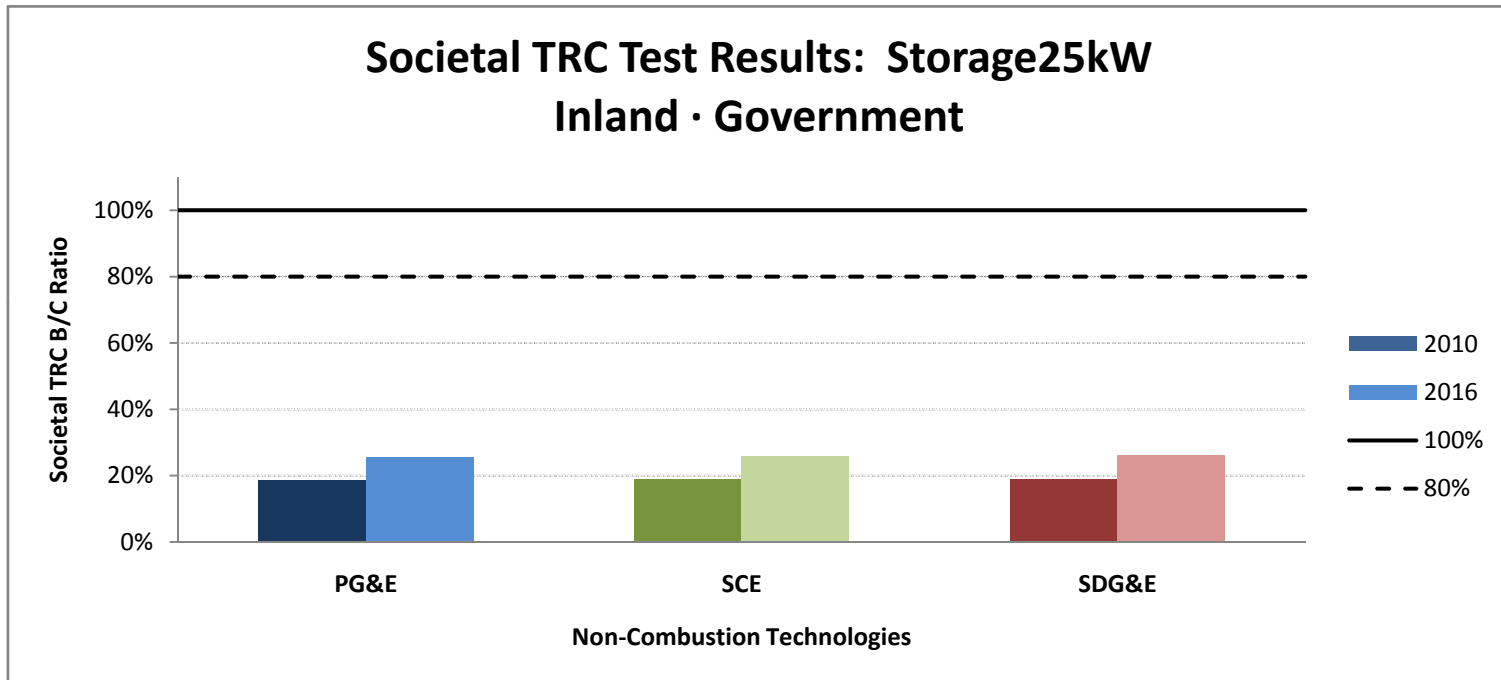

SGIP Cost Effectiveness Report
Societal TRC Test Results

Societal TRC Test Results: Storage25kW

Inland · Residential

	2010	2016
PG&E	20%	26%
SCE	21%	27%
SDG&E	21%	27%

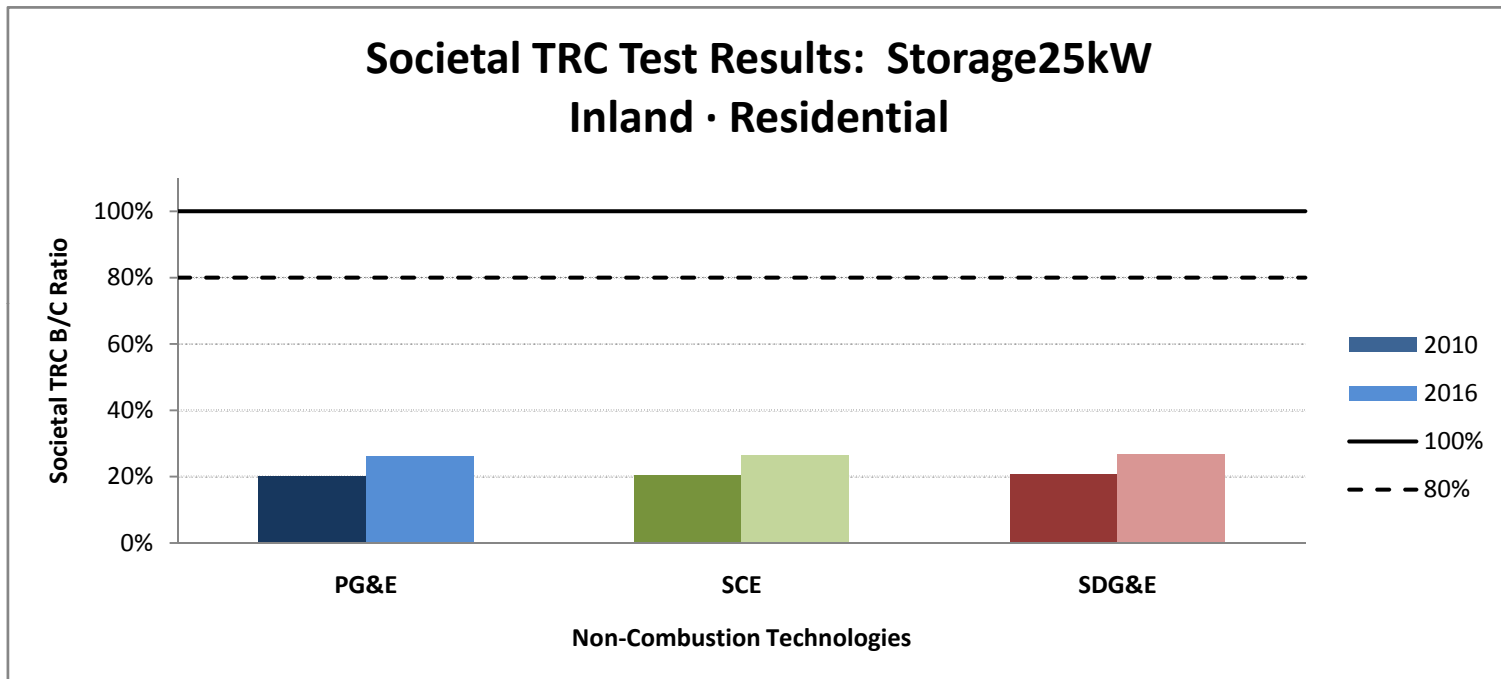

SGIP Cost Effectiveness Report
Societal TRC Test Results

Societal TRC Test Results: WD10kW
Inland · Residential

	2010	2016
PG&E	60%	74%
SCE	60%	74%
SDG&E	60%	74%

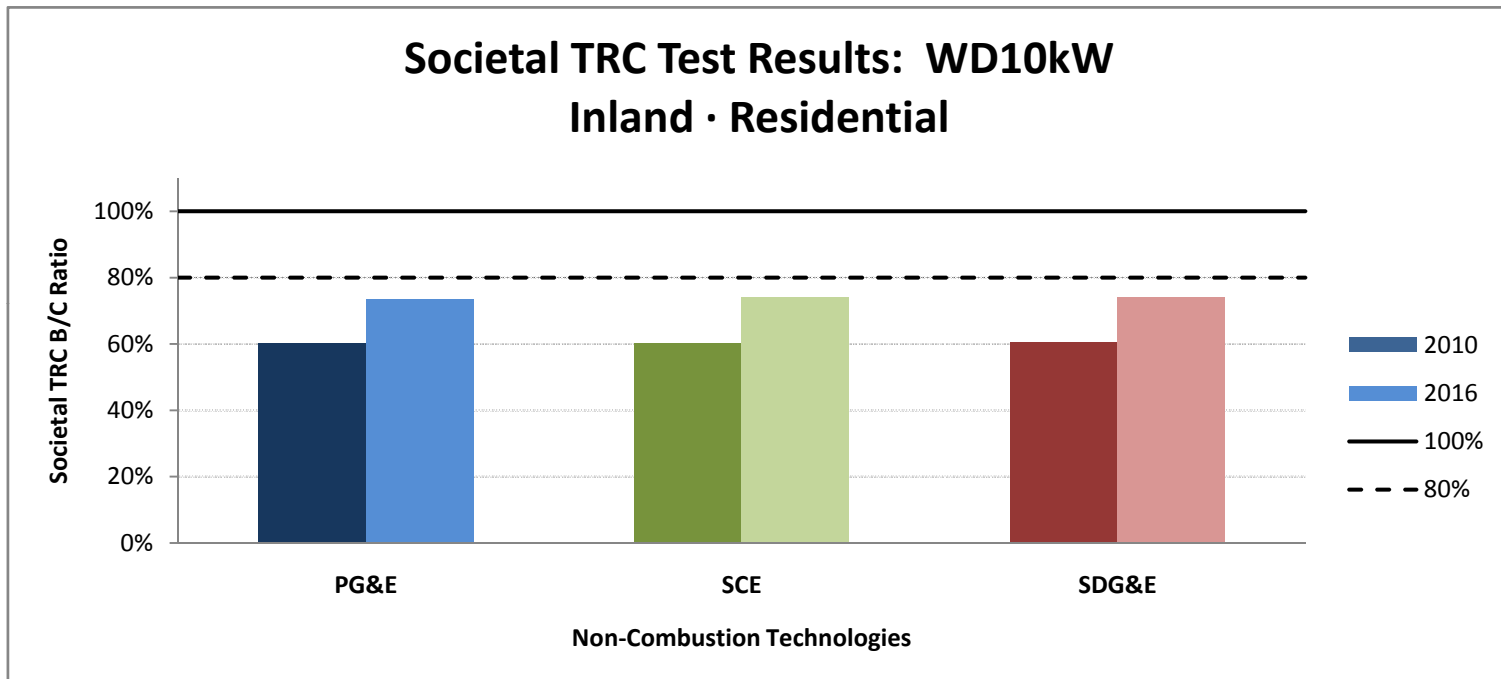

SGIP Cost Effectiveness Report
Societal TRC Test Results

Societal TRC Test Results: WD1MW

Inland · Commercial

	2010	2016
PG&E	144%	176%
SCE	144%	177%
SDG&E	145%	178%

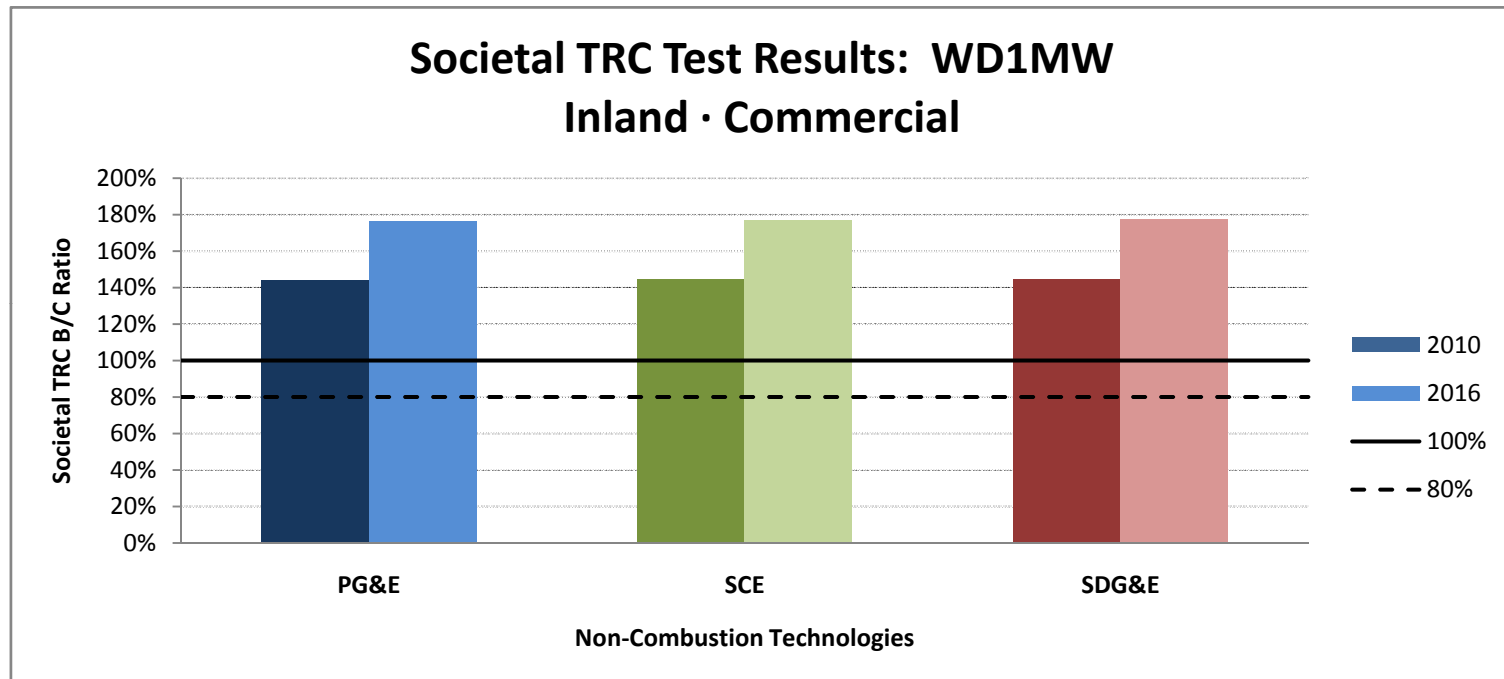

SGIP Cost Effectiveness Report
Societal TRC Test Results

Societal TRC Test Results: WD1MW

Inland · Government

	2010	2016
PG&E	112%	148%
SCE	112%	149%
SDG&E	112%	150%

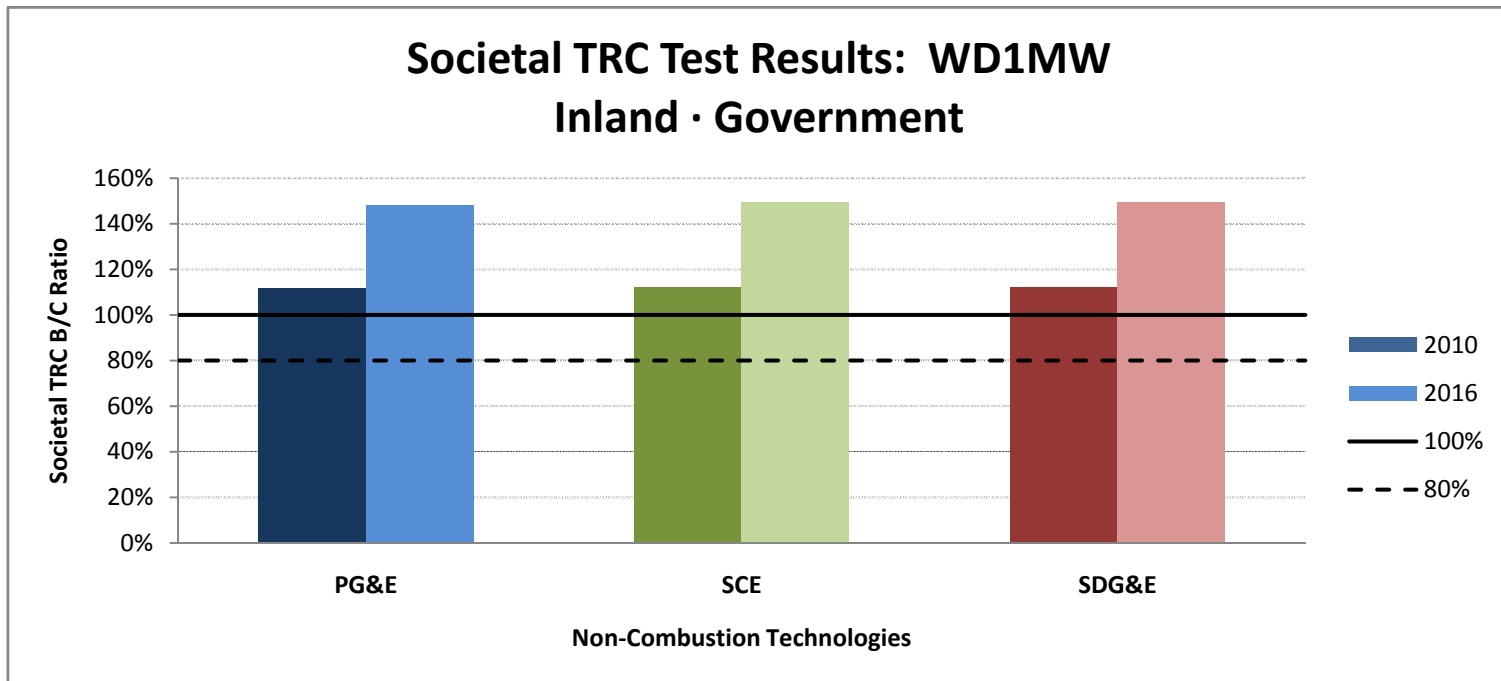

SGIP Cost Effectiveness Report
Societal TRC Test Results

Societal TRC Test Results: Direct Bio-Gas

PG&E · Inland · Non Residential

Technology	2010	2016
FC1200kWe	93%	104%
FC1200kW	107%	118%
GTg2to5MW	116%	116%
GTle2MW	95%	95%
ICE1500kW	136%	138%
ICE500kW	128%	129%
MT200kW	113%	114%

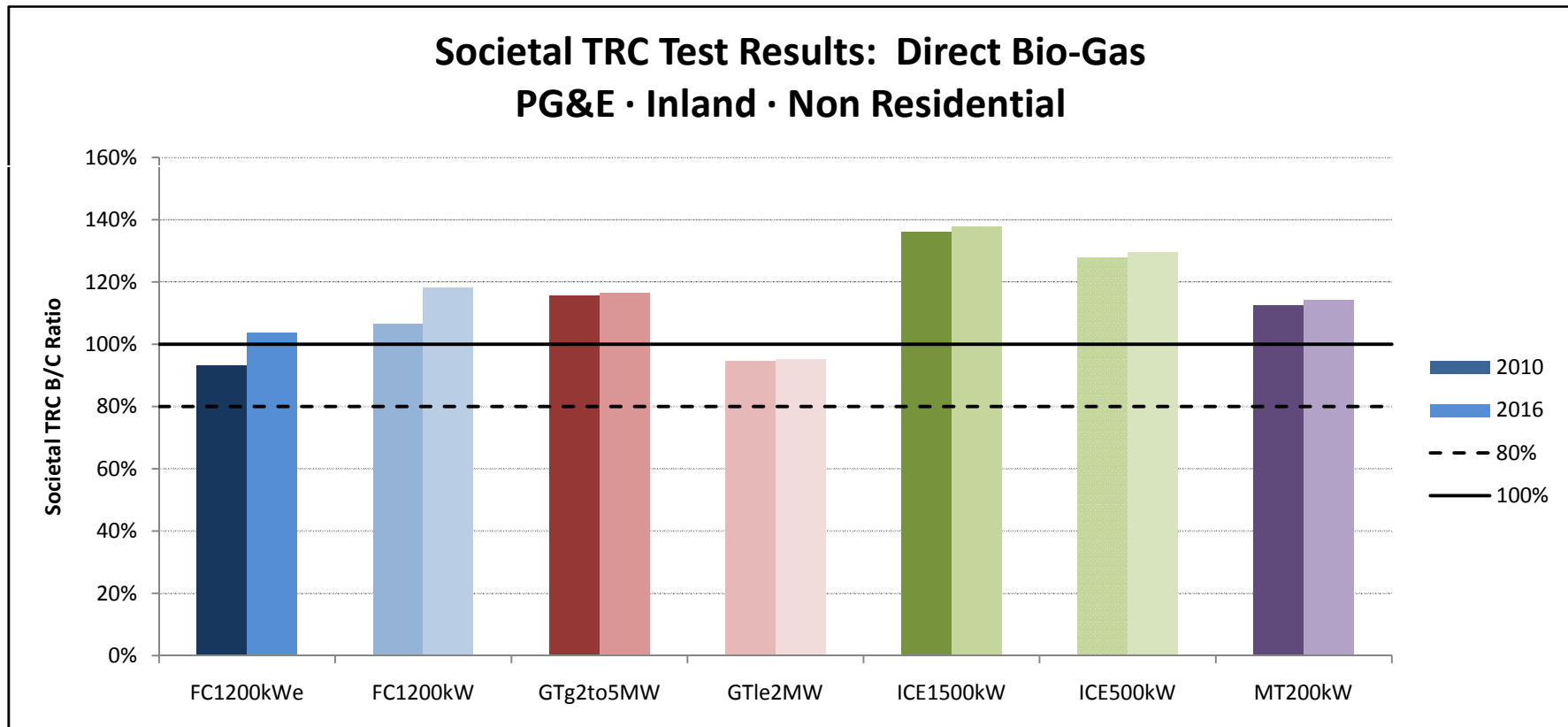

SGIP Cost Effectiveness Report
Societal TRC Test Results

Societal TRC Test Results: Direct Bio-Gas

PG&E · Inland · Government

Technology	2010	2016
FC1200kWe	53%	67%
FC1200kW	71%	86%
GTg2to5MW	87%	89%
GTle2MW	63%	65%
ICE1500kW	108%	111%
ICE500kW	100%	103%
MT200kW	85%	88%

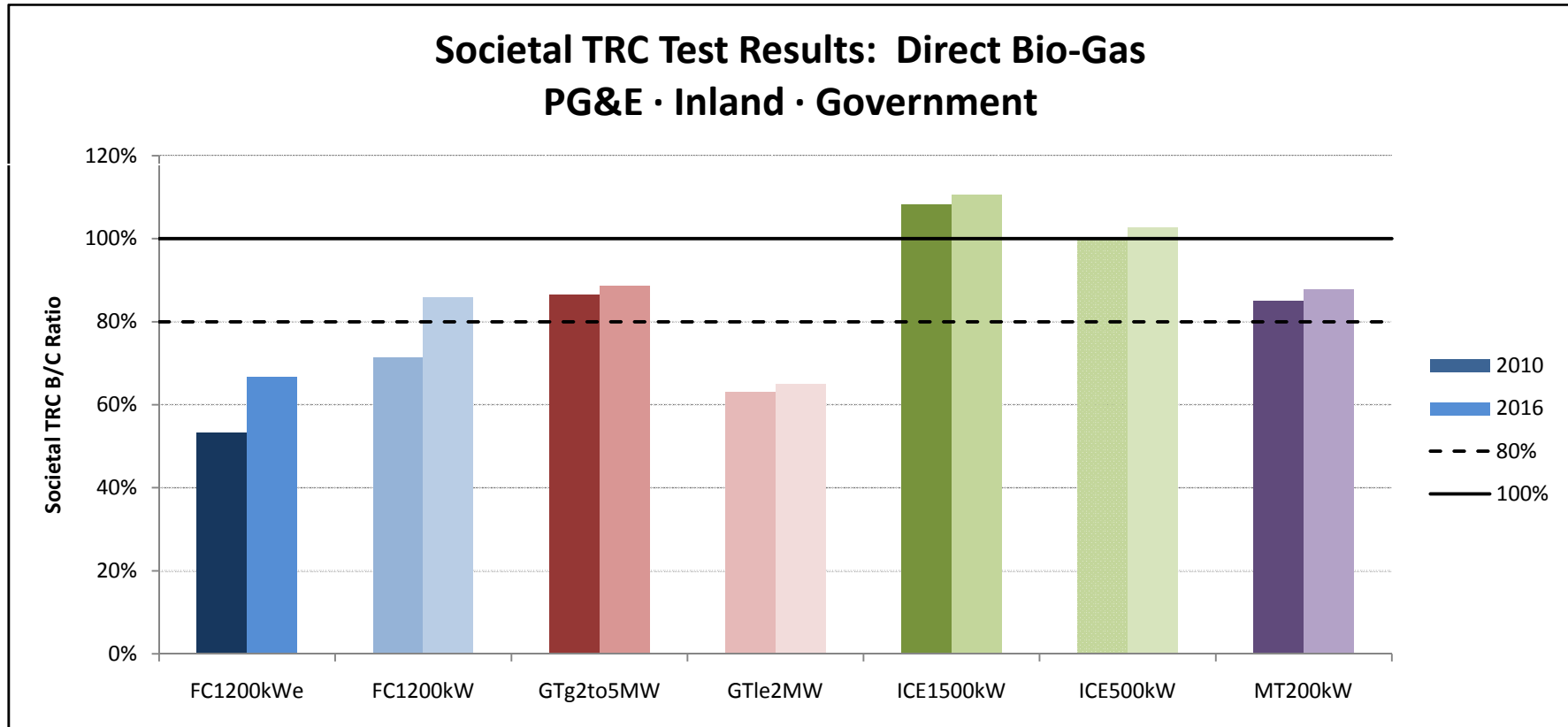

SGIP Cost Effectiveness Report
Societal TRC Test Results

Societal TRC Test Results: Natural Gas

PG&E · Inland · Non Residential

Technology	2010	2016
FC1200kWe	91%	101%
FC1200kW	104%	114%
GTg2to5MW	109%	109%
GTle2MW	88%	88%
ICE1500kW	129%	129%
ICE500kW	121%	122%
MT200kW	105%	106%

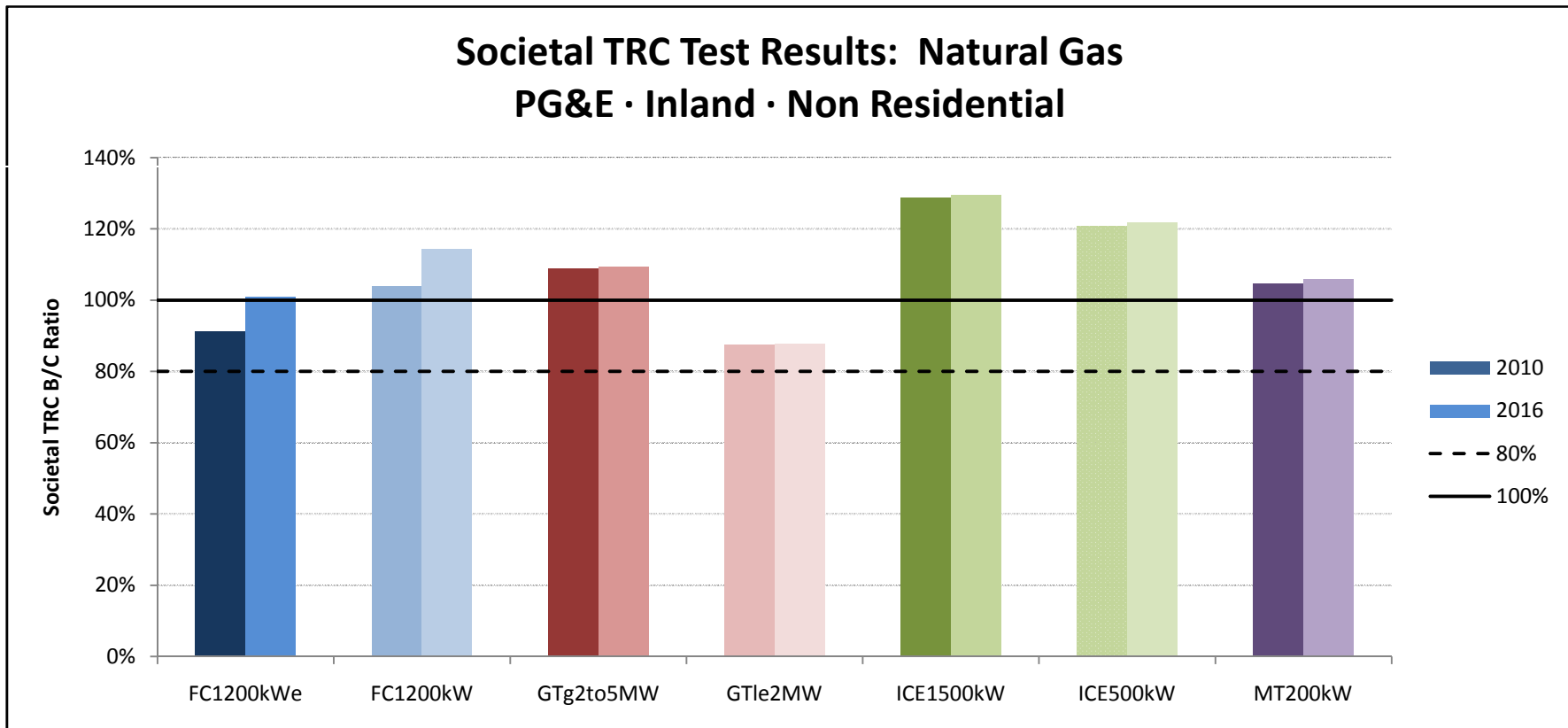

SGIP Cost Effectiveness Report
Societal TRC Test Results

Societal TRC Test Results: Natural Gas

PG&E · Inland · Government

Technology	2010	2016
FC1200kWe	53%	67%
FC1200kW	71%	86%
GTg2to5MW	87%	89%
GTle2MW	63%	65%
ICE1500kW	108%	111%
ICE500kW	100%	103%
MT200kW	85%	88%

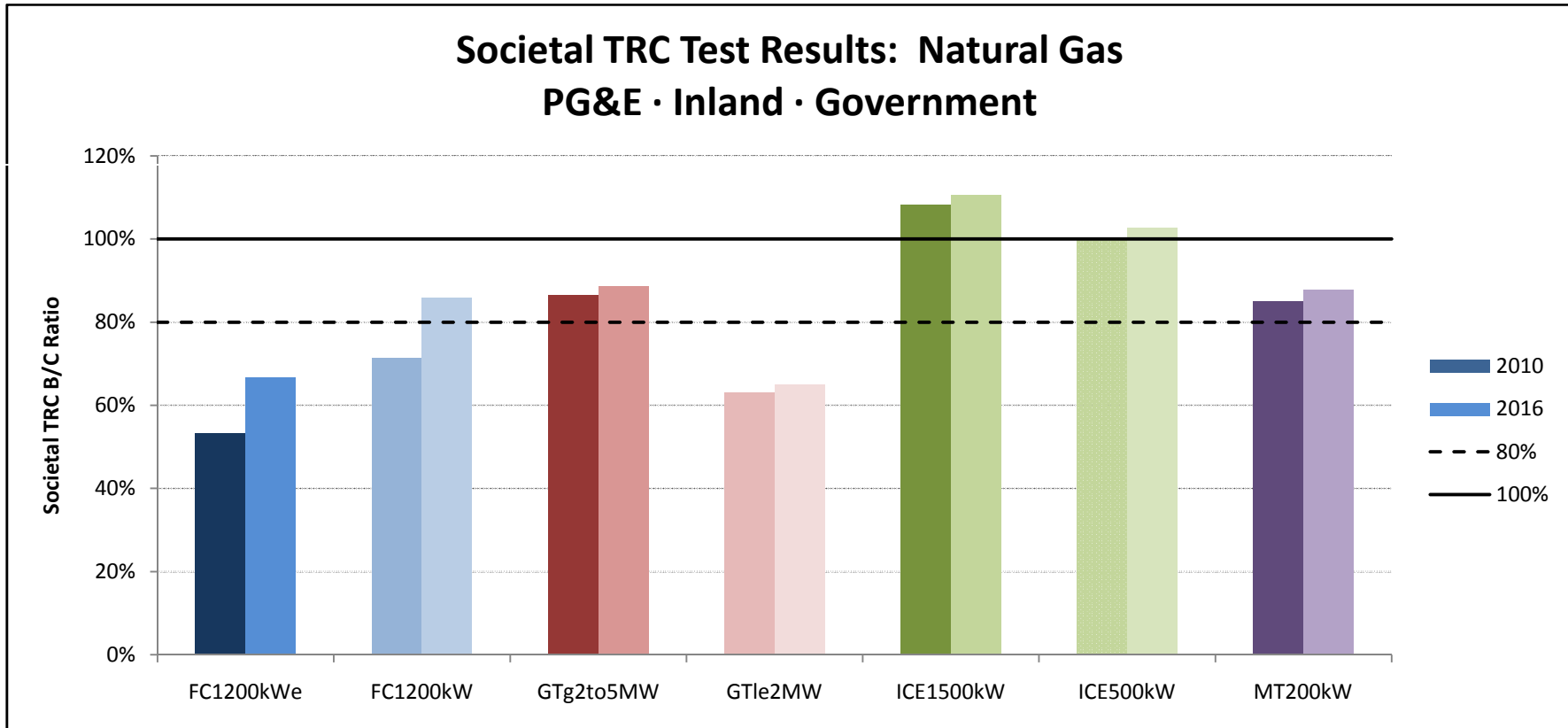

SGIP Cost Effectiveness Report
Societal TRC Test Results

Societal TRC Test Results: Onsite Bio-Gas

PG&E · Inland · Non Residential

Technology	2010	2016
FC1200kWe	87%	100%
FC1200kW	101%	119%
GTg2to5MW	117%	123%
GTle2MW	89%	92%
ICE1500kW	151%	172%
ICE500kW	182%	239%
MT200kW	124%	152%

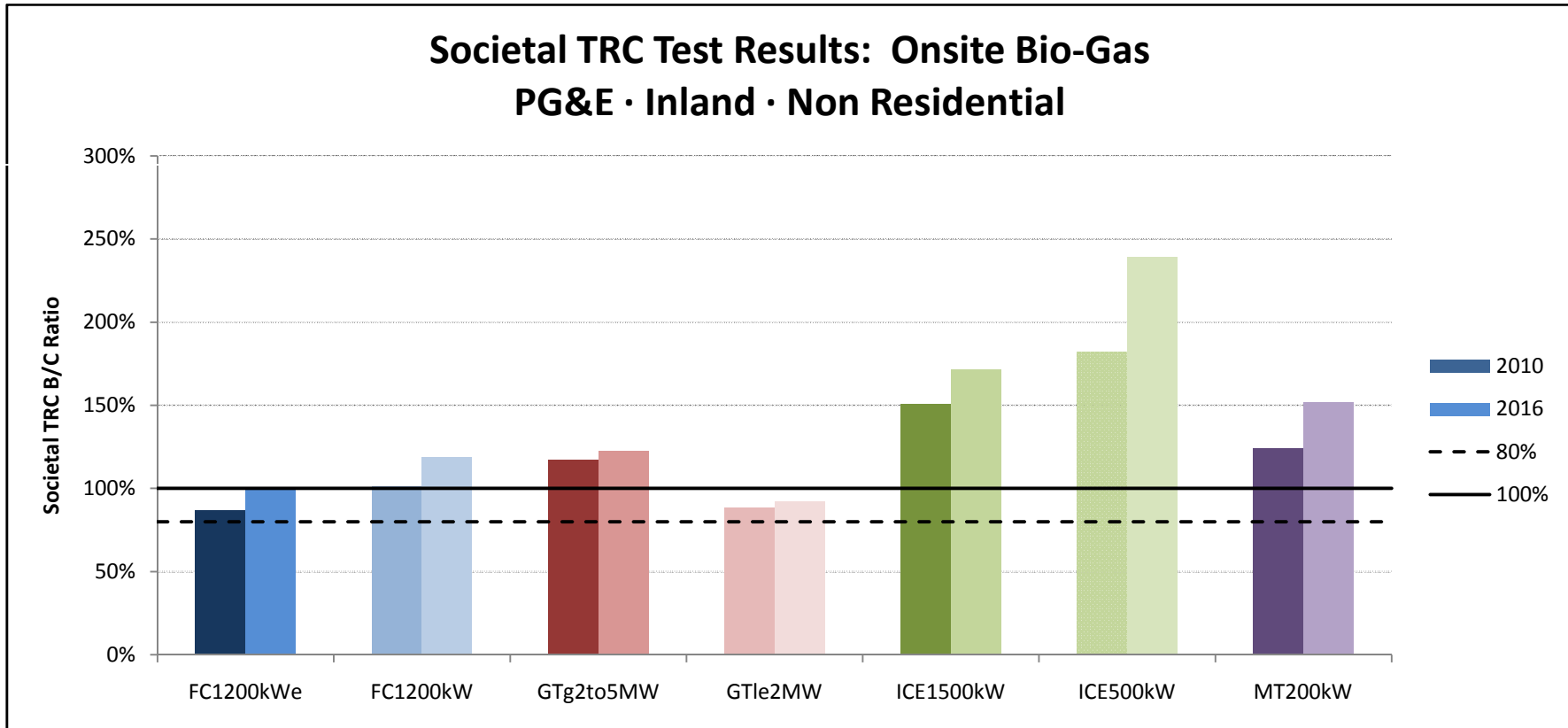

SGIP Cost Effectiveness Report
Societal TRC Test Results

Societal TRC Test Results: Onsite Bio-Gas

PG&E · Inland · Government

Technology	2010	2016
FC1200kWe	50%	69%
FC1200kW	72%	95%
GTg2to5MW	105%	113%
GTle2MW	71%	77%
ICE1500kW	146%	172%
ICE500kW	166%	229%
MT200kW	102%	133%

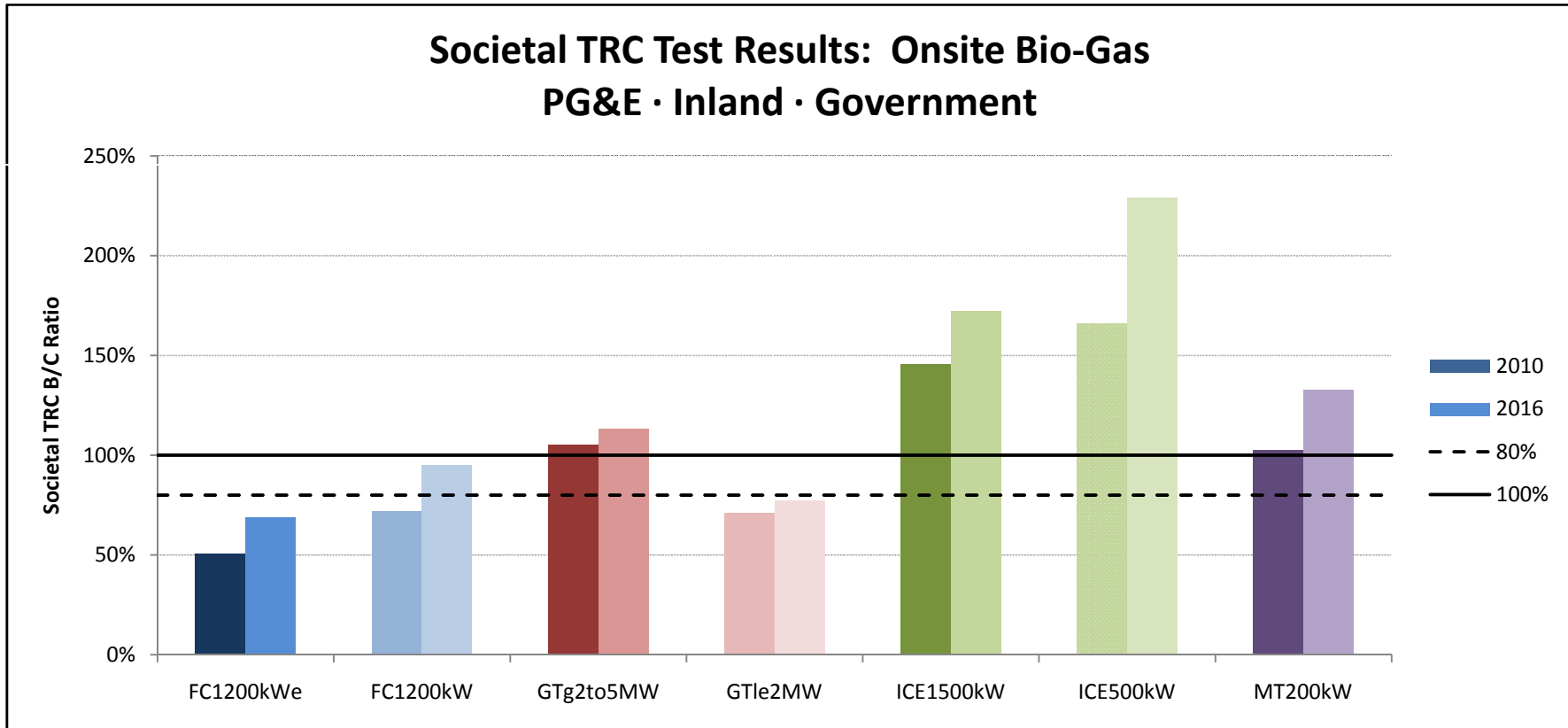

SGIP Cost Effectiveness Report
Societal TRC Test Results

Societal TRC Test Results: Direct Bio-Gas

SCE · Inland · Non Residential

Technology	2010	2016
FC1200kWe	94%	105%
FC1200kW	107%	119%
GTg2to5MW	117%	117%
GTle2MW	96%	96%
ICE1500kW	138%	139%
ICE500kW	129%	131%
MT200kW	114%	115%

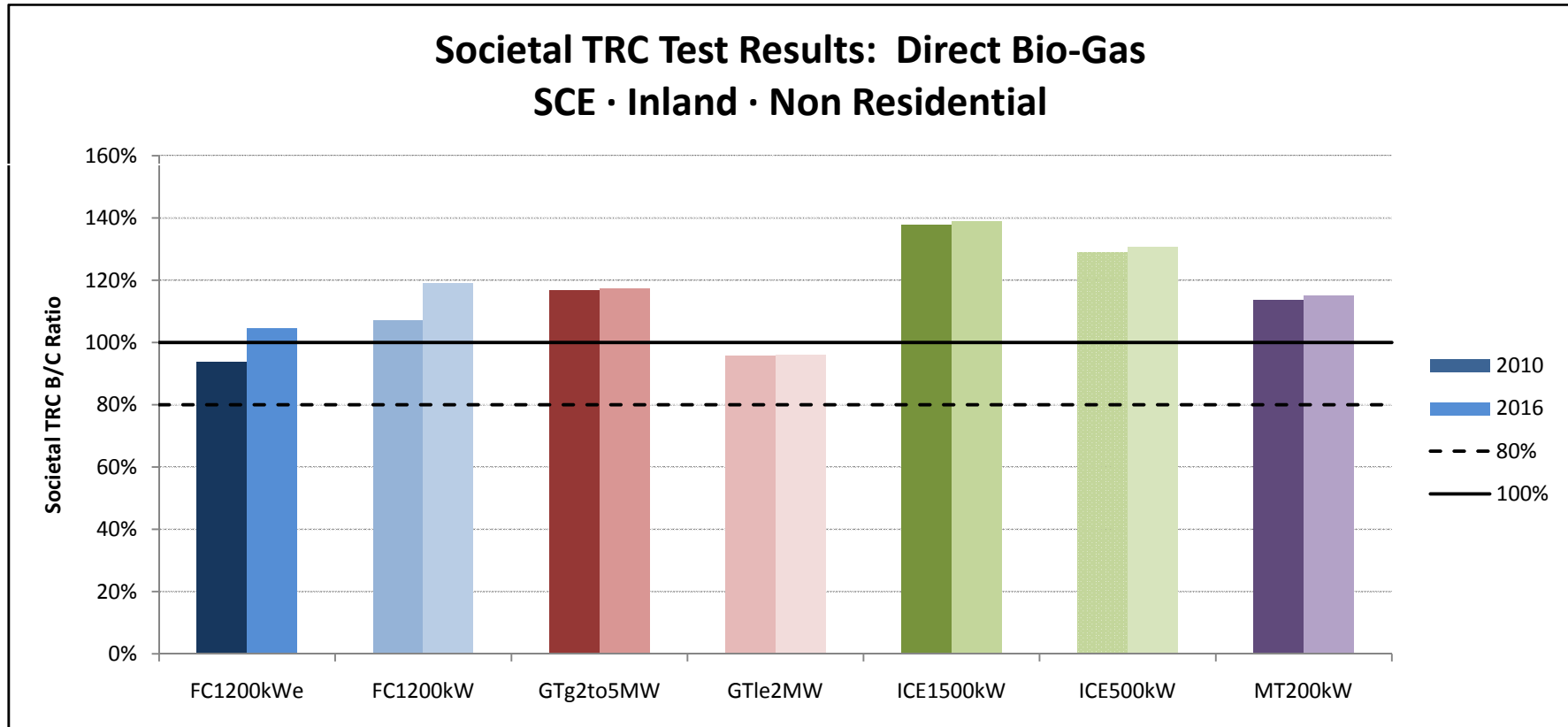

SGIP Cost Effectiveness Report
Societal TRC Test Results

Societal TRC Test Results: Direct Bio-Gas

SCE · Inland · Government

Technology	2010	2016
FC1200kWe	54%	67%
FC1200kW	72%	86%
GTg2to5MW	87%	89%
GTle2MW	64%	65%
ICE1500kW	109%	111%
ICE500kW	101%	104%
MT200kW	86%	88%

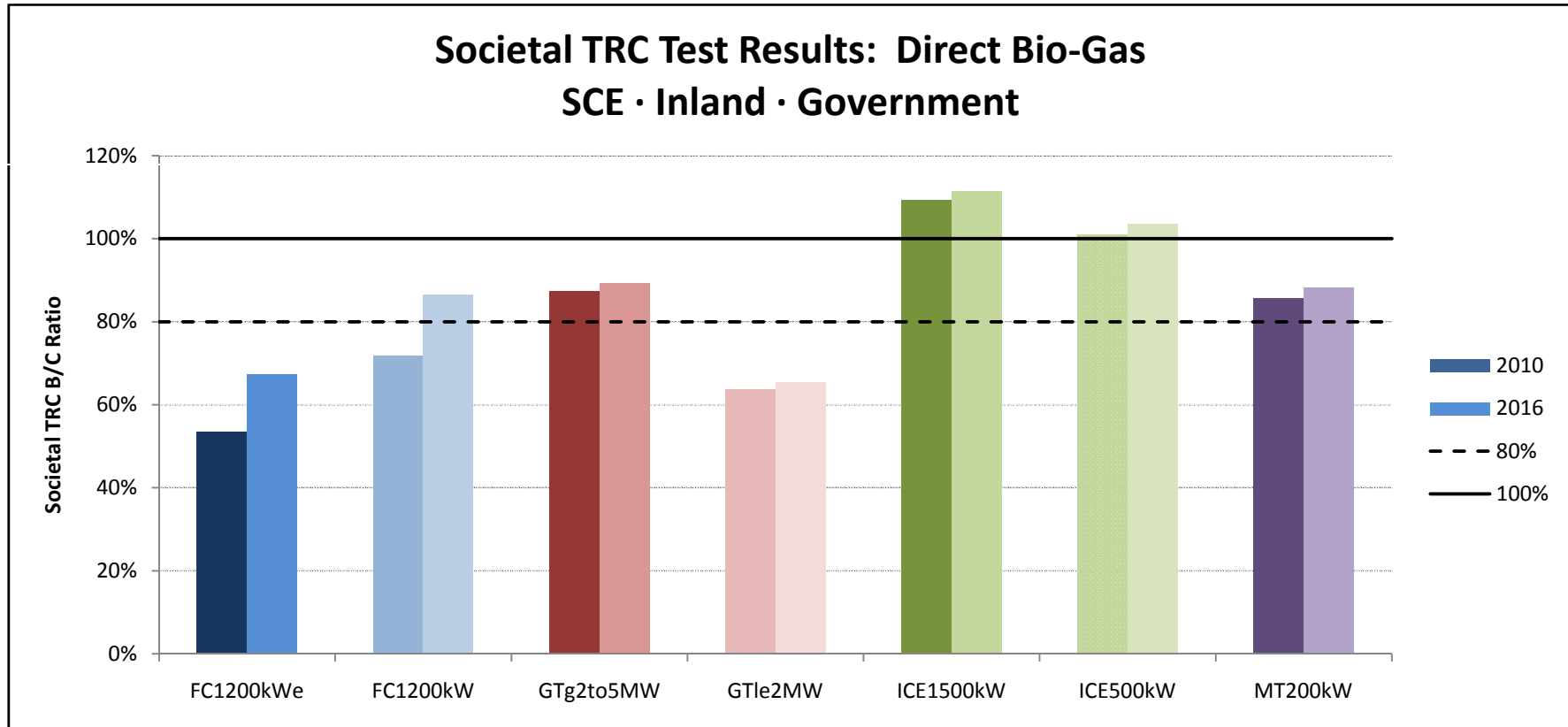

SGIP Cost Effectiveness Report
Societal TRC Test Results

Societal TRC Test Results: Natural Gas

SCE · Inland · Non Residential

Technology	2010	2016
FC1200kWe	92%	101%
FC1200kW	104%	115%
GTg2to5MW	110%	110%
GTle2MW	88%	88%
ICE1500kW	130%	131%
ICE500kW	122%	123%
MT200kW	106%	107%

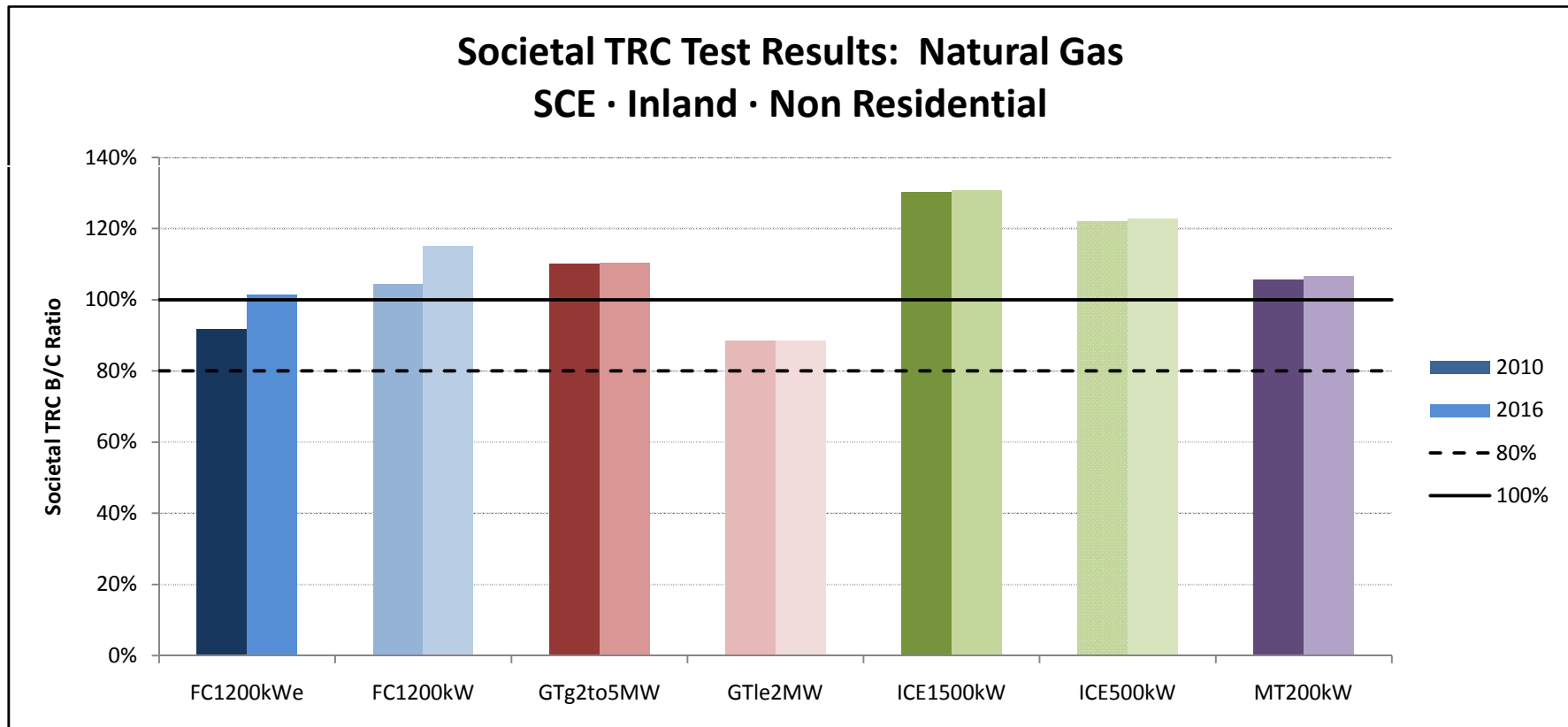

SGIP Cost Effectiveness Report
Societal TRC Test Results

Societal TRC Test Results: Natural Gas

SCE · Inland · Government

Technology	2010	2016
FC1200kWe	54%	67%
FC1200kW	72%	86%
GTg2to5MW	87%	89%
GTle2MW	64%	65%
ICE1500kW	109%	111%
ICE500kW	101%	104%
MT200kW	86%	88%

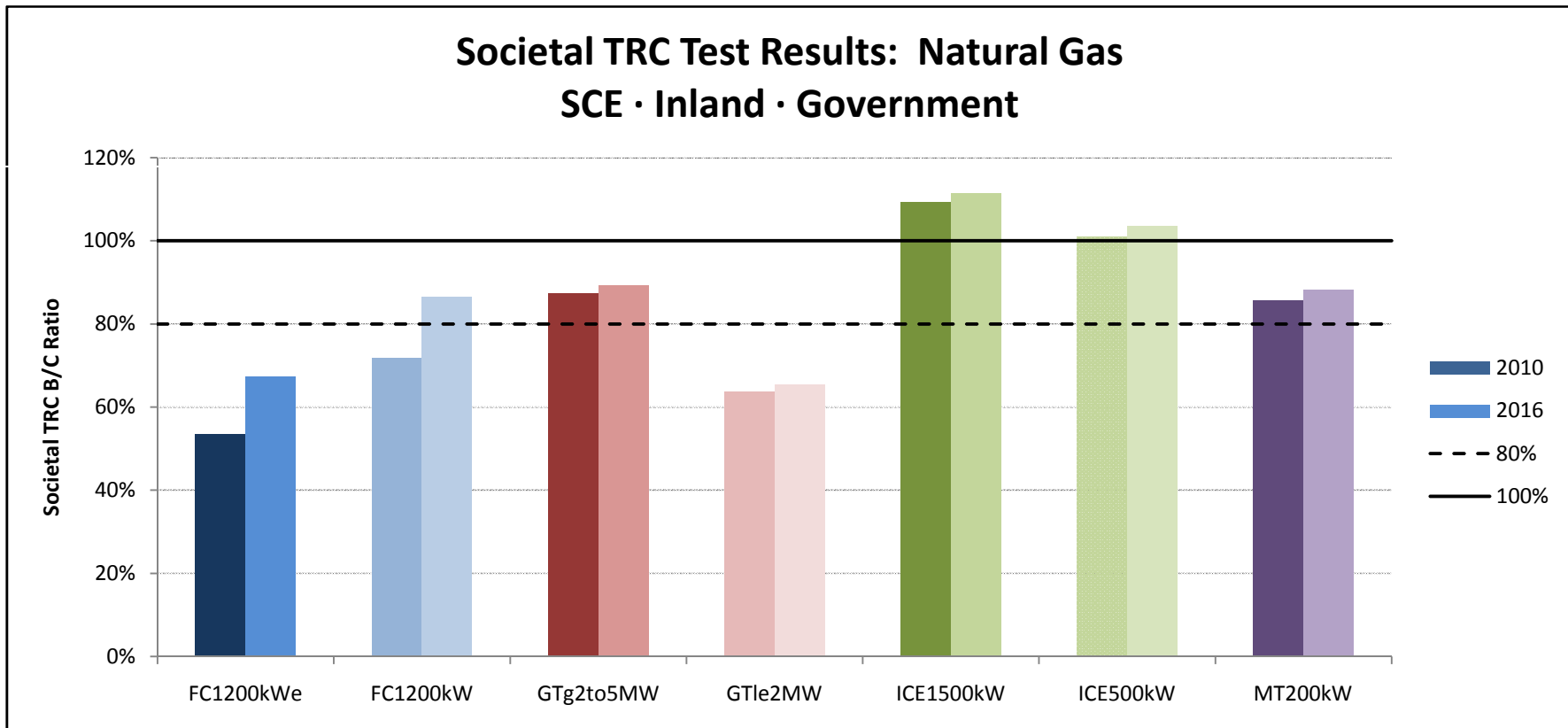

SGIP Cost Effectiveness Report
Societal TRC Test Results

Societal TRC Test Results: Onsite Bio-Gas

SCE · Inland · Non Residential

Technology	2010	2016
FC1200kWe	87%	101%
FC1200kW	101%	119%
GTg2to5MW	117%	123%
GTle2MW	89%	93%
ICE1500kW	151%	172%
ICE500kW	182%	239%
MT200kW	124%	152%

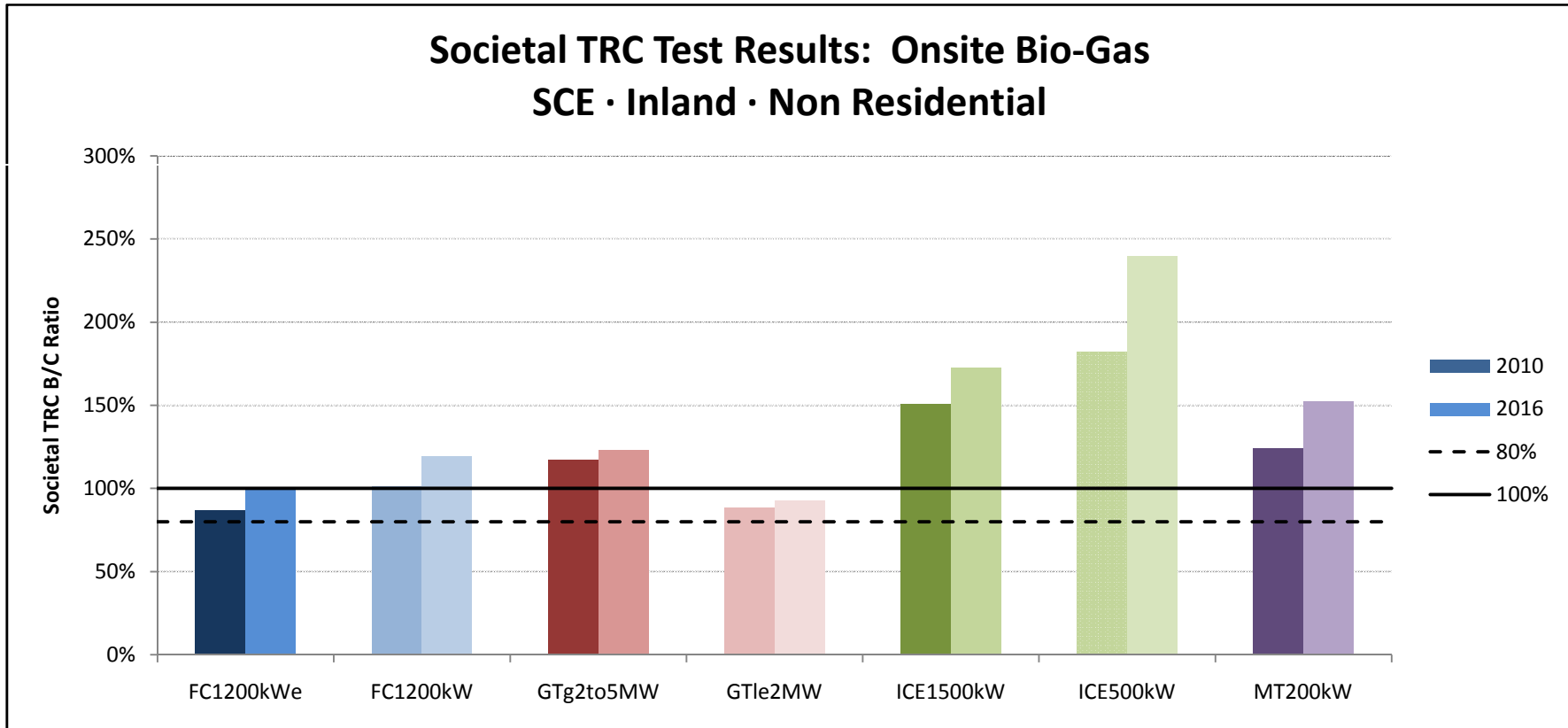

SGIP Cost Effectiveness Report
Societal TRC Test Results

Societal TRC Test Results: Onsite Bio-Gas

SCE · Inland · Government

Technology	2010	2016
FC1200kWe	50%	69%
FC1200kW	72%	95%
GTg2to5MW	105%	114%
GTle2MW	71%	78%
ICE1500kW	145%	173%
ICE500kW	166%	229%
MT200kW	102%	133%

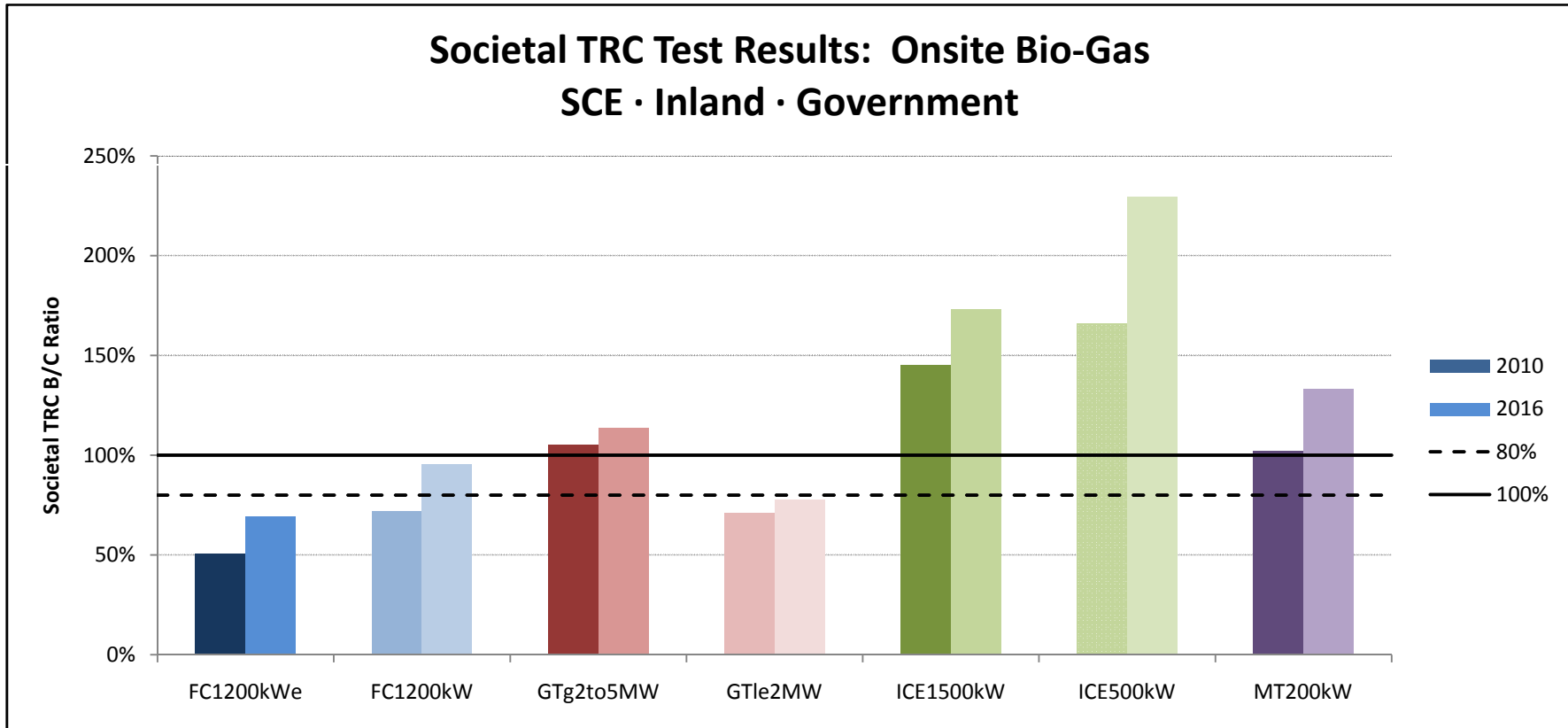

SGIP Cost Effectiveness Report
Societal TRC Test Results

Societal TRC Test Results: Direct Bio-Gas

SDG&E · Inland · Non Residential

Technology	2010	2016
FC1200kWe	94%	105%
FC1200kW	108%	120%
GTg2to5MW	118%	118%
GTle2MW	97%	97%
ICE1500kW	139%	140%
ICE500kW	131%	132%
MT200kW	115%	117%

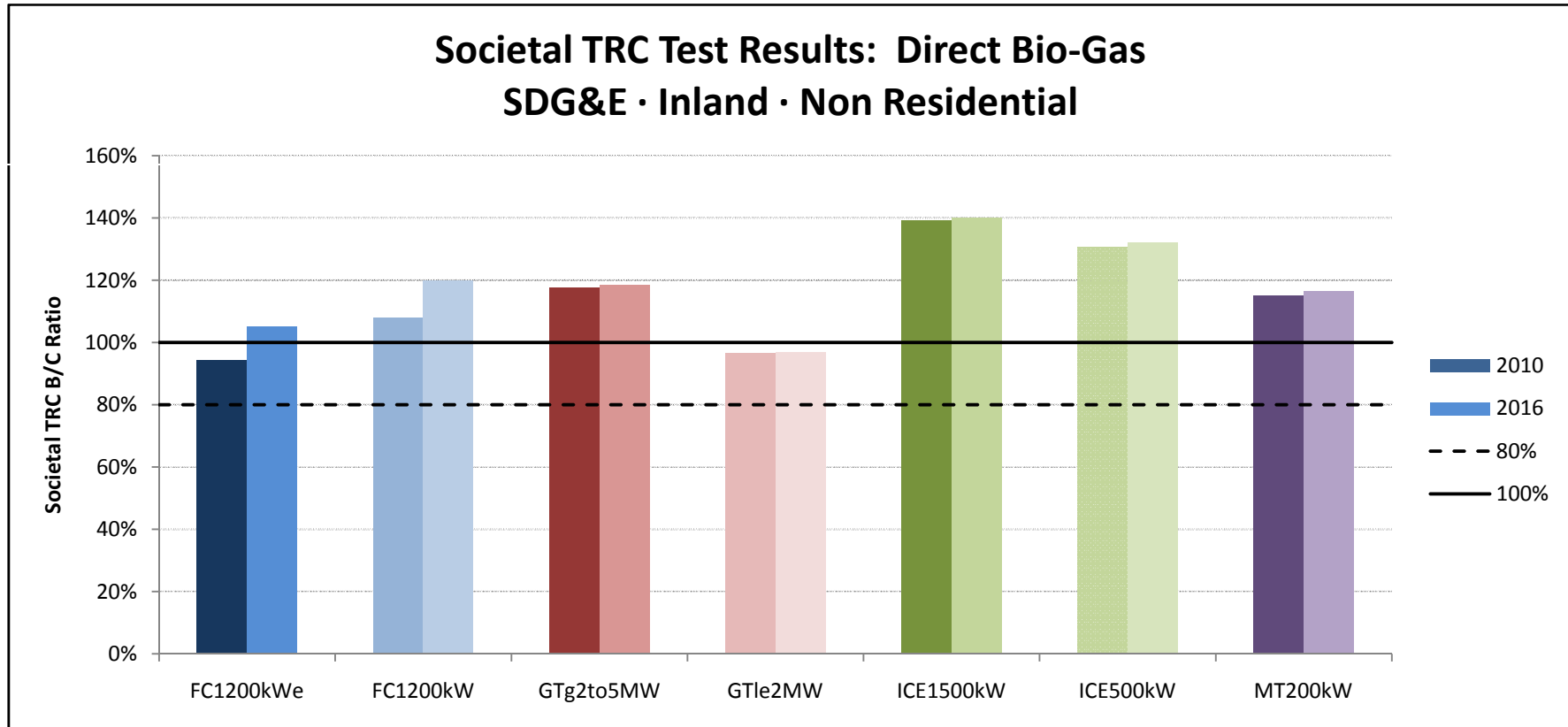

SGIP Cost Effectiveness Report
Societal TRC Test Results

Societal TRC Test Results: Direct Bio-Gas

SDG&E · Inland · Government

Technology	2010	2016
FC1200kWe	54%	68%
FC1200kW	72%	87%
GTg2to5MW	88%	89%
GTle2MW	64%	66%
ICE1500kW	110%	112%
ICE500kW	101%	104%
MT200kW	86%	89%

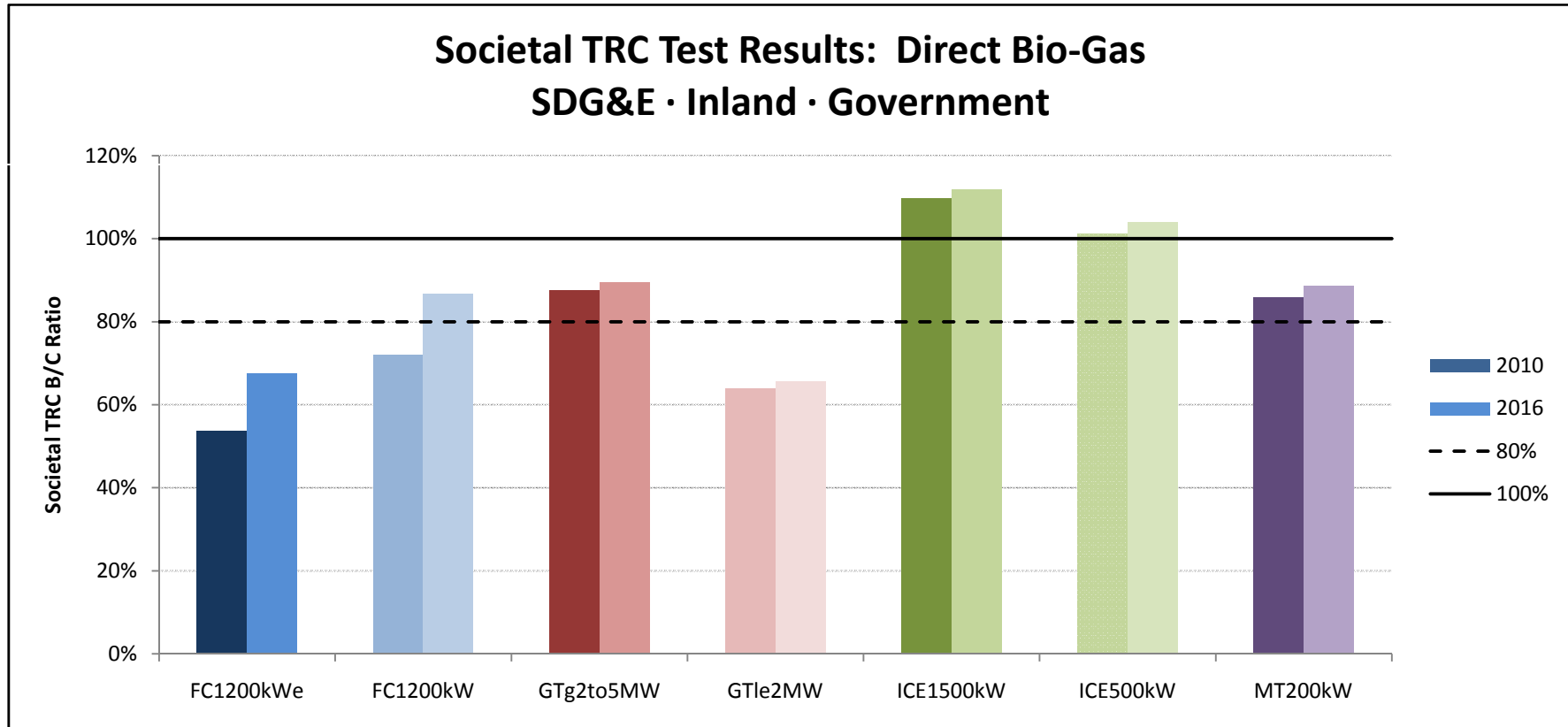

SGIP Cost Effectiveness Report
Societal TRC Test Results

Societal TRC Test Results: Natural Gas

SDG&E · Inland · Non Residential

Technology	2010	2016
FC1200kWe	92%	102%
FC1200kW	105%	116%
GTg2to5MW	111%	111%
GTle2MW	89%	89%
ICE1500kW	132%	132%
ICE500kW	124%	124%
MT200kW	107%	108%

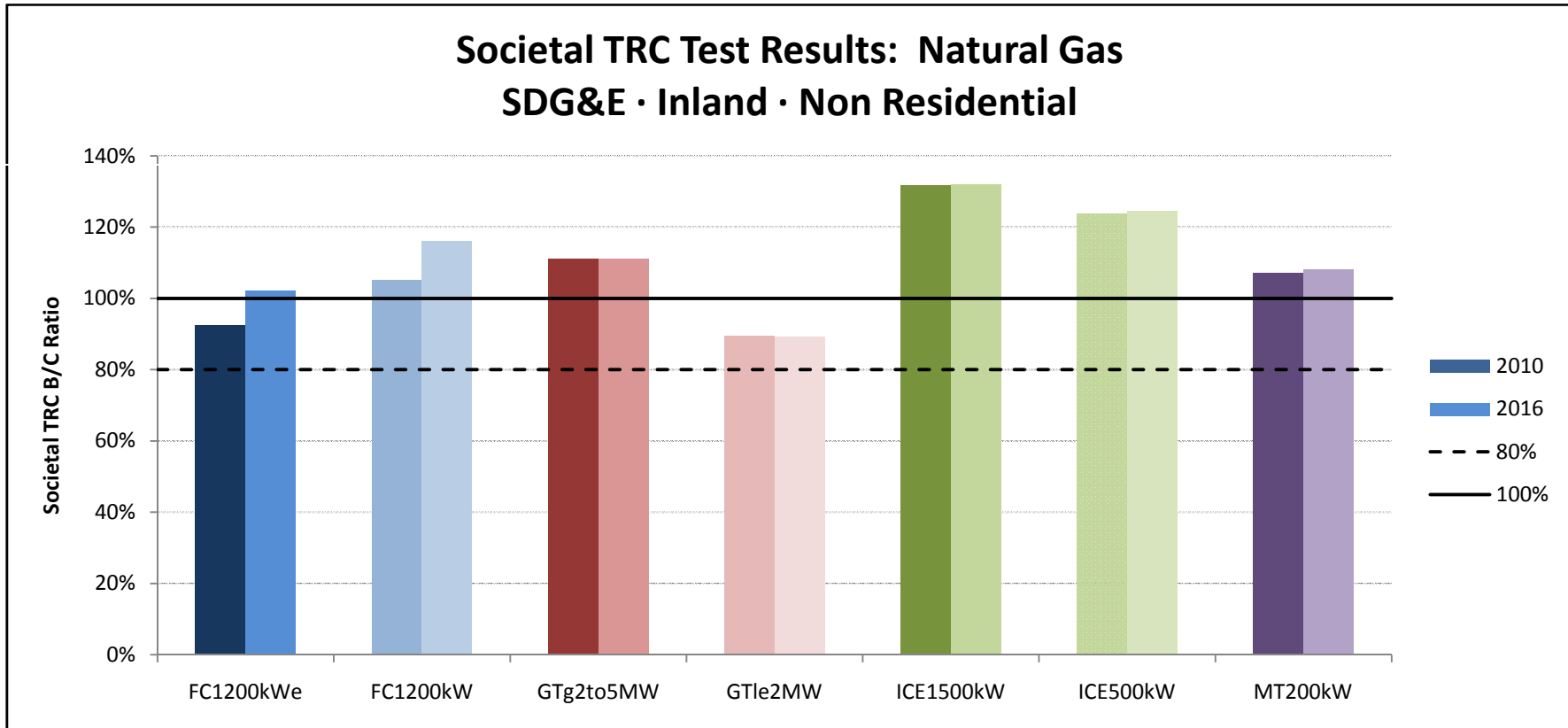

SGIP Cost Effectiveness Report
Societal TRC Test Results

Societal TRC Test Results: Natural Gas

SDG&E · Inland · Government

Technology	2010	2016
FC1200kWe	54%	68%
FC1200kW	72%	87%
GTg2to5MW	88%	89%
GTle2MW	64%	66%
ICE1500kW	110%	112%
ICE500kW	101%	104%
MT200kW	86%	89%

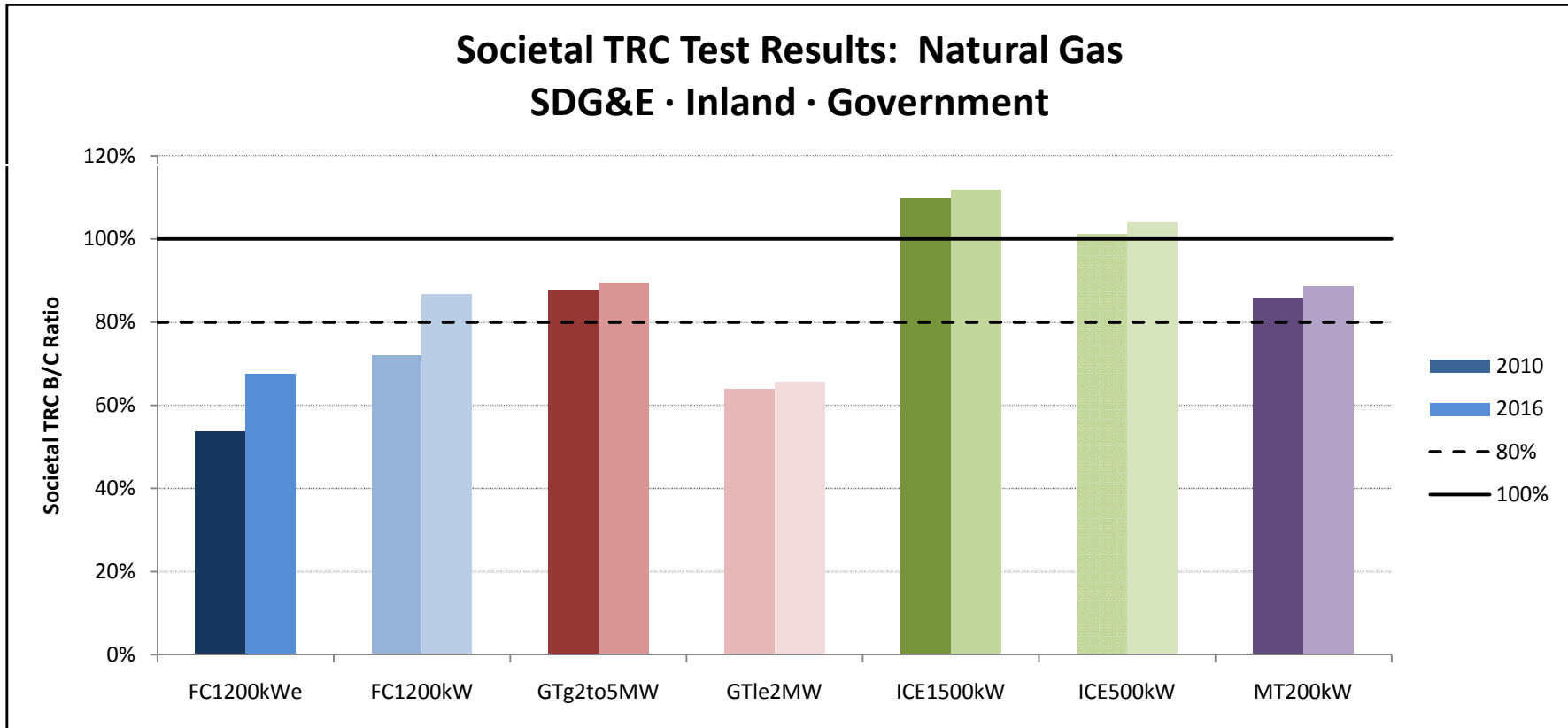

SGIP Cost Effectiveness Report
Societal TRC Test Results

Societal TRC Test Results: Onsite Bio-Gas

SDG&E · Inland · Non Residential

Technology	2010	2016
FC1200kWe	87%	101%
FC1200kW	101%	120%
GTg2to5MW	117%	123%
GTle2MW	89%	93%
ICE1500kW	151%	173%
ICE500kW	182%	240%
MT200kW	125%	153%

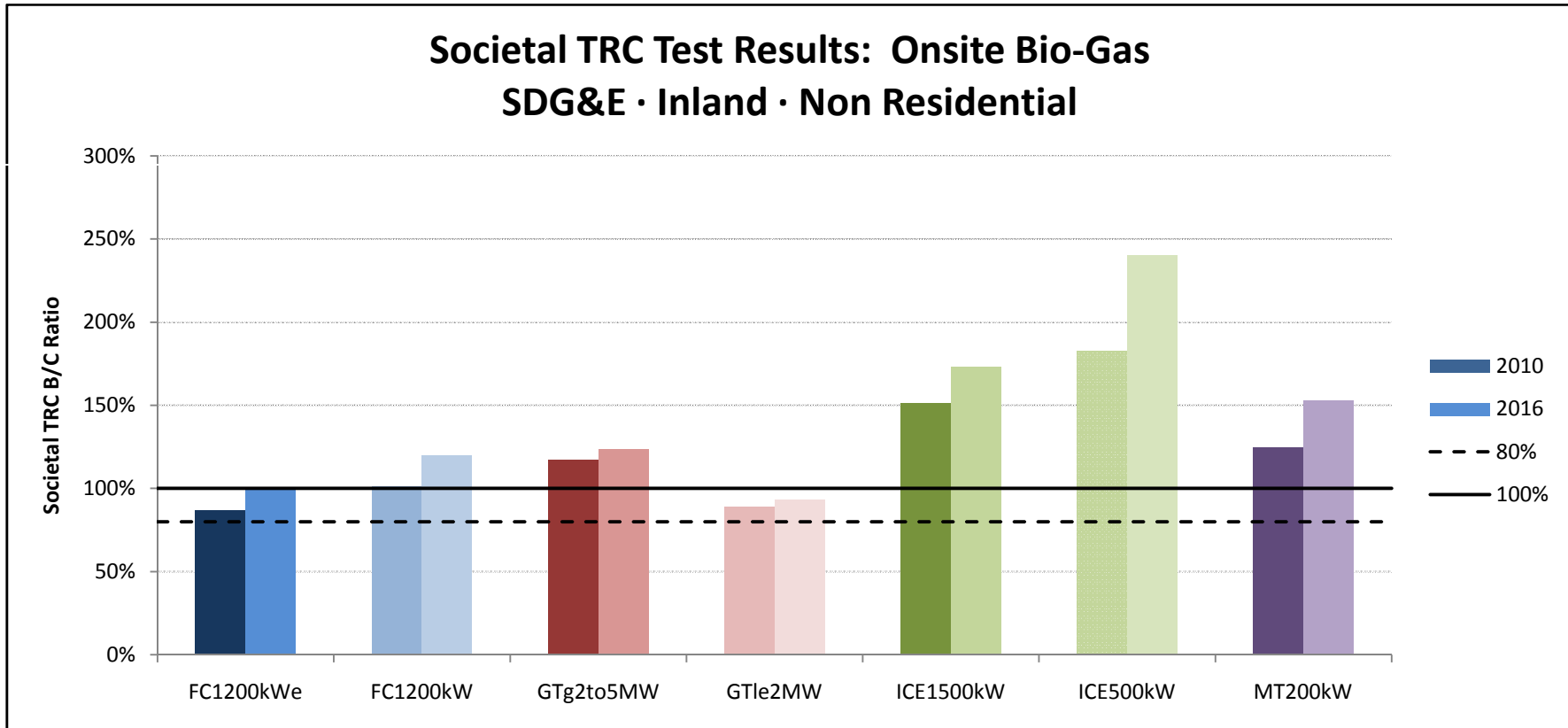

SGIP Cost Effectiveness Report
Societal TRC Test Results

Societal TRC Test Results: Onsite Bio-Gas

SDG&E · Inland · Government

Technology	2010	2016
FC1200kWe	51%	69%
FC1200kW	72%	96%
GTg2to5MW	105%	114%
GTle2MW	71%	78%
ICE1500kW	146%	173%
ICE500kW	166%	230%
MT200kW	102%	133%

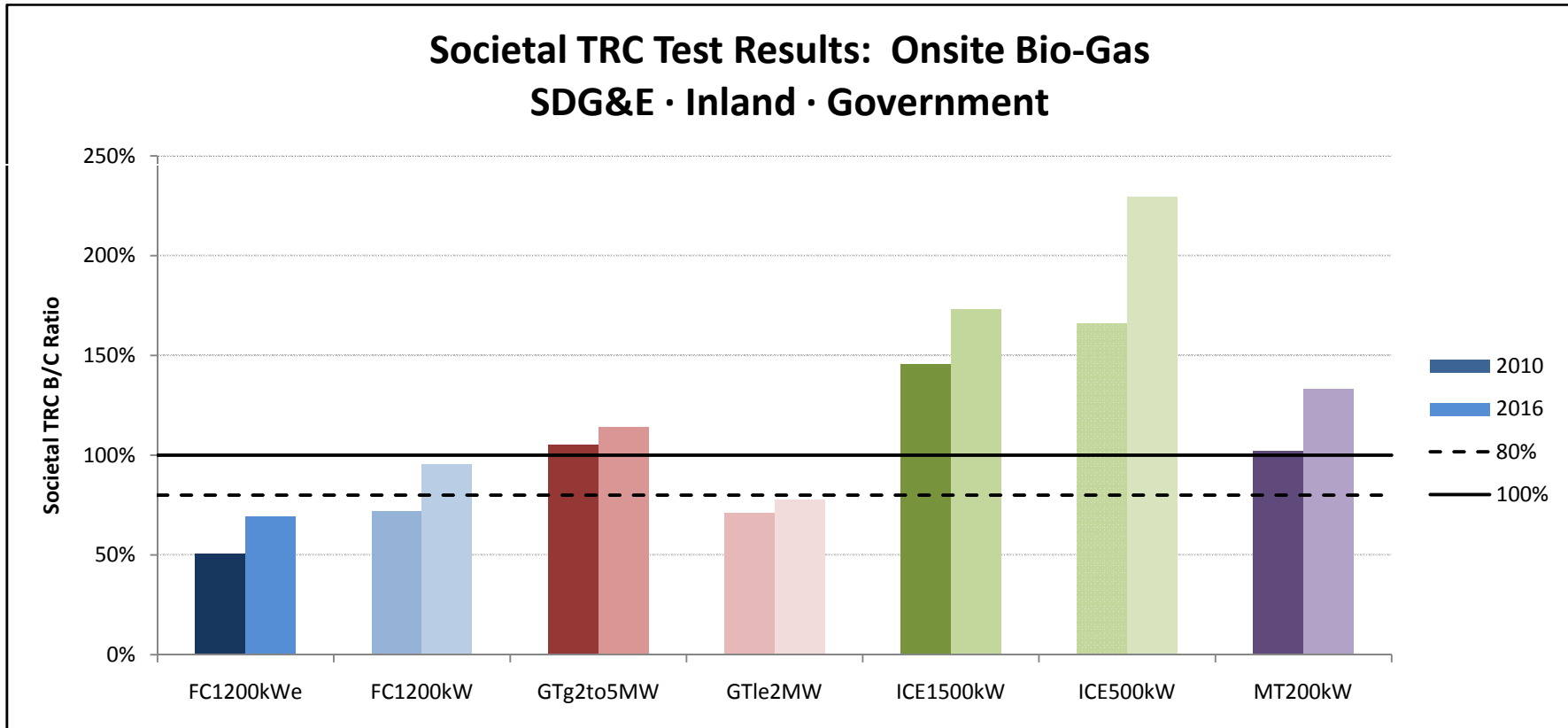

SGIP Cost Effectiveness Report

**PCT Results
Commercial
No Rebate**

Technology	SGIPce System Size (kW)	PG&E		SCE		SDG&E		Statewide - Equal		Statewide - Elec Sales	
		PCT - 2010	MIRR	PCT - 2010	MIRR	PCT - 2010	MIRR	PCT - 2010	MIRR	PCT - 2010	MIRR
Wind Turbine											
- 1 MW	1,000	1.63	14.5%	1.57	14.2%	1.36	13.0%	1.52	13.9%	1.58	14.2%
Fuel Cell - Electric Only											
- Natural gas	1,200	0.95	9.4%	0.93	9.1%	0.82	7.3%	0.90	8.6%	0.93	9.1%
- On site biogas	1,200	1.00	10.3%	0.99	10.1%	0.89	8.7%	0.96	9.7%	0.98	10.0%
- Directed biogas	1,200	0.92	8.8%	0.91	8.5%	0.82	6.6%	0.88	8.0%	0.91	8.5%
Fuel Cell - CHP (i.e., w/waste heat recovery)											
- Natural gas powered	1,200	1.02	10.6%	1.00	10.2%	0.86	7.6%	0.96	9.5%	0.99	10.1%
- On site biogas	1,200	1.12	11.7%	1.10	11.5%	0.97	9.8%	1.06	11.0%	1.09	11.4%
- Directed biogas	1,200	0.98	9.7%	0.95	9.1%	0.84	6.3%	0.93	8.4%	0.95	9.1%
Gas Turbine - CHP											
- Natural gas powered (1000 kW)	1,000	0.89	6.3%	0.88	5.7%	0.75	1.2%	0.84	4.4%	0.87	5.5%
- On site biogas (1000 kW)	1,000	1.06	10.9%	1.05	10.7%	0.91	8.3%	1.01	9.9%	1.04	10.5%
- Directed biogas (1000 kW)	1,000	0.81	0.0%	0.80	-0.5%	0.71	-5.4%	0.77	-2.0%	0.80	-0.8%
- Natural gas powered (3500 kW)	3,500	1.07	12.2%	1.05	11.6%	0.88	4.5%	1.00	9.4%	1.04	11.2%
- On site biogas (3500 kW)	3,500	1.40	14.8%	1.38	14.6%	1.17	12.4%	1.32	14.0%	1.37	14.5%
- Directed biogas (3500 kW)	3,500	0.95	6.8%	0.94	5.8%	0.81	-3.9%	0.90	2.9%	0.93	5.3%
Microturbine - CHP											
- Natural gas powered	200	0.98	9.2%	0.98	9.3%	0.84	3.1%	0.93	7.2%	0.97	8.7%
- On site biogas	200	0.82	7.0%	0.83	7.0%	0.75	5.7%	0.80	6.6%	0.82	6.9%
- Directed biogas	200	0.87	0.9%	0.87	1.0%	0.77	-5.8%	0.84	-1.3%	0.86	0.3%
IC Engine - CHP											
- Natural gas powered (500 kW)	500	1.18	14.5%	1.18	14.6%	0.99	9.6%	1.11	12.9%	1.16	14.1%
- On site biogas (500 kW)	500	1.06	10.7%	1.07	10.8%	0.94	9.2%	1.03	10.2%	1.05	10.6%
- Directed biogas (500 kW)	500	1.02	11.0%	1.02	11.1%	0.89	1.6%	0.98	7.9%	1.01	10.1%
- Natural gas powered (1500 kW)	1,500	1.24	15.9%	1.24	15.9%	1.03	11.3%	1.17	14.4%	1.22	15.4%
- On site biogas (1500 kW)	1,500	1.81	17.4%	1.82	17.5%	1.54	15.8%	1.72	16.9%	1.79	17.3%
- Directed biogas (1500 kW)	1,500	1.05	12.6%	1.06	12.7%	0.92	3.0%	1.01	9.4%	1.04	11.7%
Organic Rankine Cycle											
	500	1.22	11.8%	1.21	11.8%	1.01	10.1%	1.15	11.2%	1.19	11.6%
Storage											
- Med storage	25	0.46	-14.1%	0.45	-13.4%	0.42	-13.3%	0.44	-13.6%	0.45	-13.7%
- Larger storage	1,000	0.51	-14.9%	0.50	-13.9%	0.47	-13.4%	0.49	-14.1%	0.50	-14.3%

SGIP Cost Effectiveness Report
PCT Test Results

PCT Test Results: Onsite Bio-Gas
Statewide · Commercial

Technology	PG&E	SCE	SDG&E	Ave
FC1200kWe	100%	99%	89%	96%
FC1200kW	112%	110%	97%	106%
GTg2to5MW	140%	138%	117%	132%
GTle2MW	106%	105%	91%	101%
ICE1500kW	181%	182%	154%	172%
ICE500kW	106%	107%	94%	103%
MT200kW	82%	83%	75%	80%

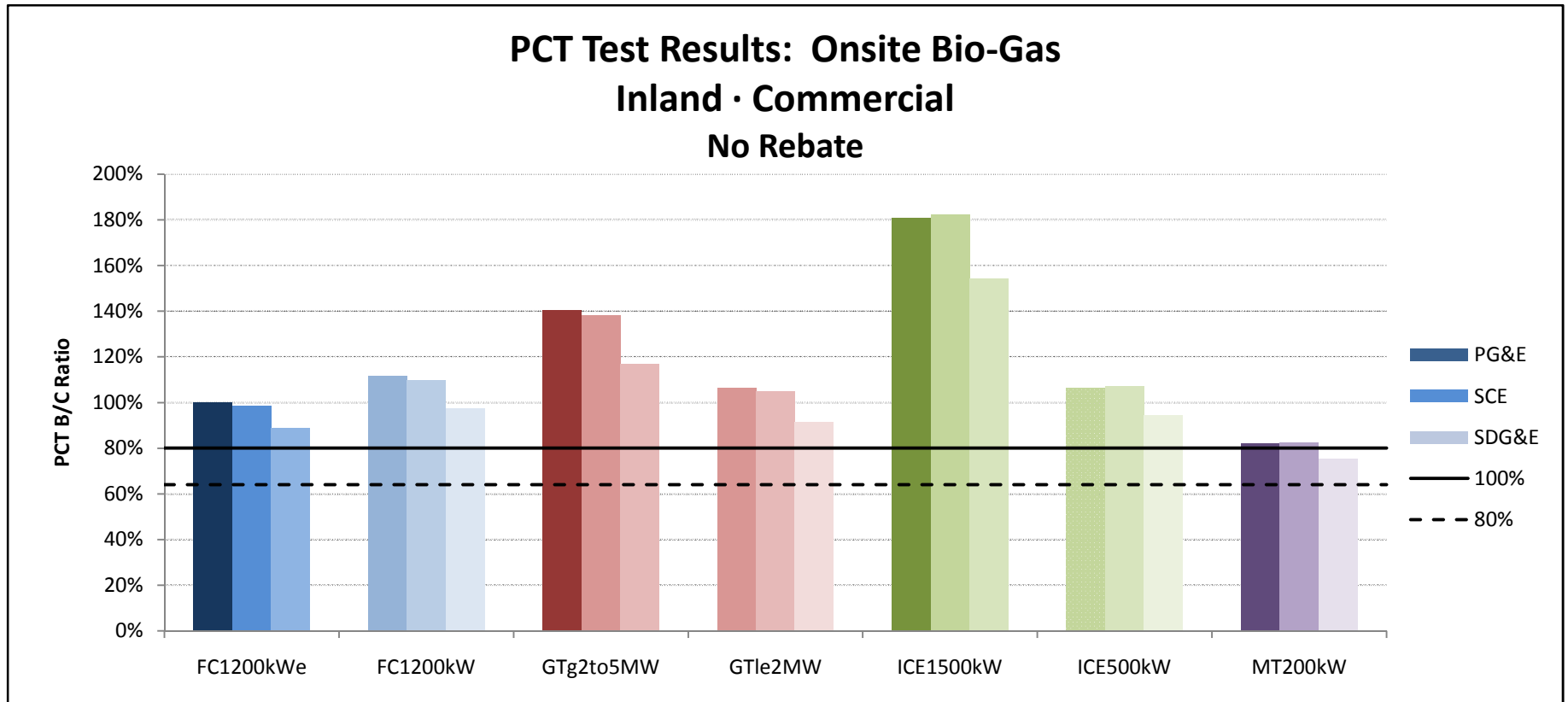

SGIP Cost Effectiveness Report
PCT Test Results

PCT TRC Test Results: Direct Bio-Gas

Statewide · Commercial

Technology	PG&E	SCE	SDG&E	Ave
FC1200kWe	92%	91%	82%	88%
FC1200kW	98%	95%	84%	93%
GTg2to5MW	95%	94%	81%	90%
GTle2MW	81%	80%	71%	77%
ICE1500kW	105%	106%	92%	101%
ICE500kW	102%	102%	89%	98%
MT200kW	87%	87%	77%	84%

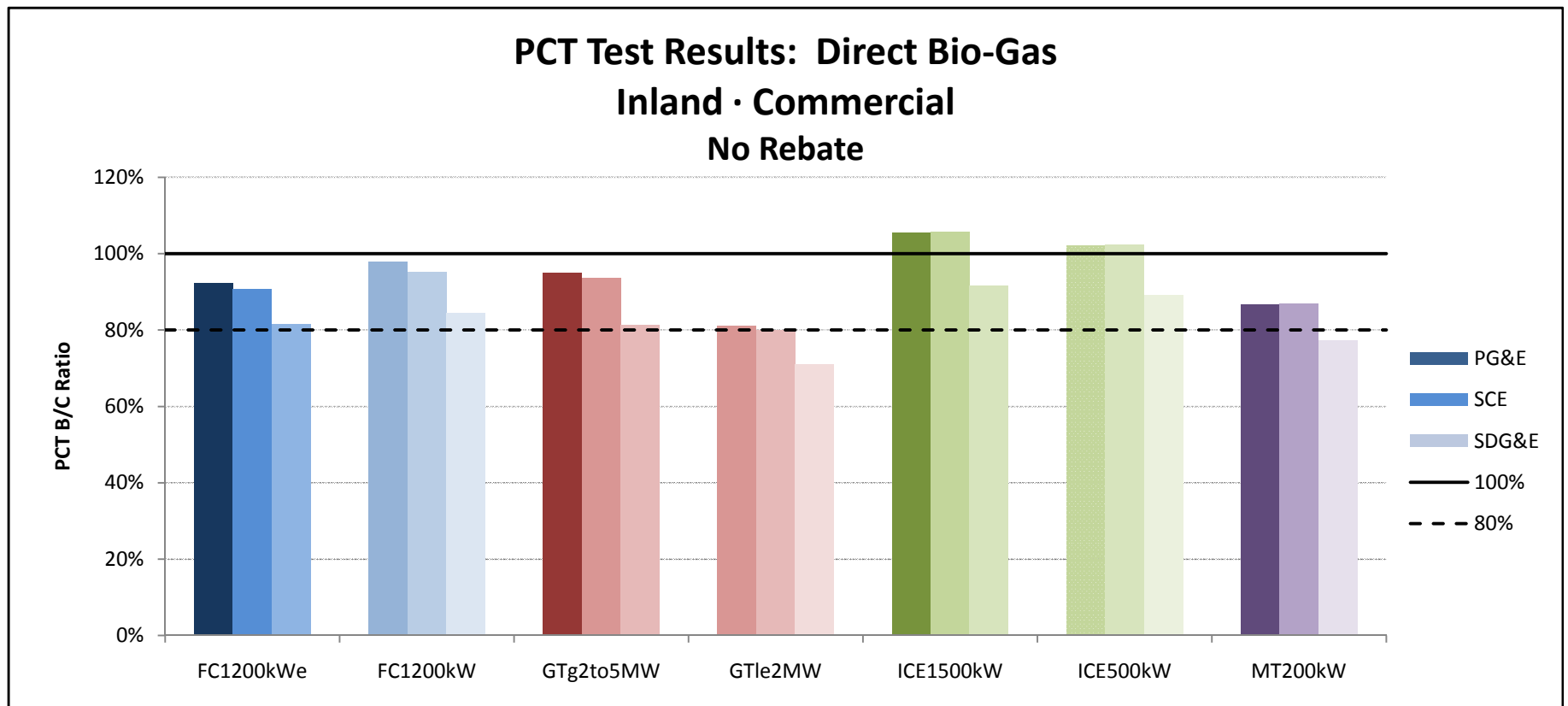

SGIP Cost Effectiveness Report
PCT Test Results

PCT TRC Test Results: Natural Gas
Statewide · Commercial

Technology	PG&E	SCE	SDG&E	Ave
FC1200kWe	95%	93%	82%	90%
FC1200kW	102%	100%	86%	96%
GTg2to5MW	107%	105%	88%	100%
GTle2MW	89%	88%	75%	84%
ICE1500kW	124%	124%	103%	117%
ICE500kW	118%	118%	99%	111%
MT200kW	98%	98%	84%	93%

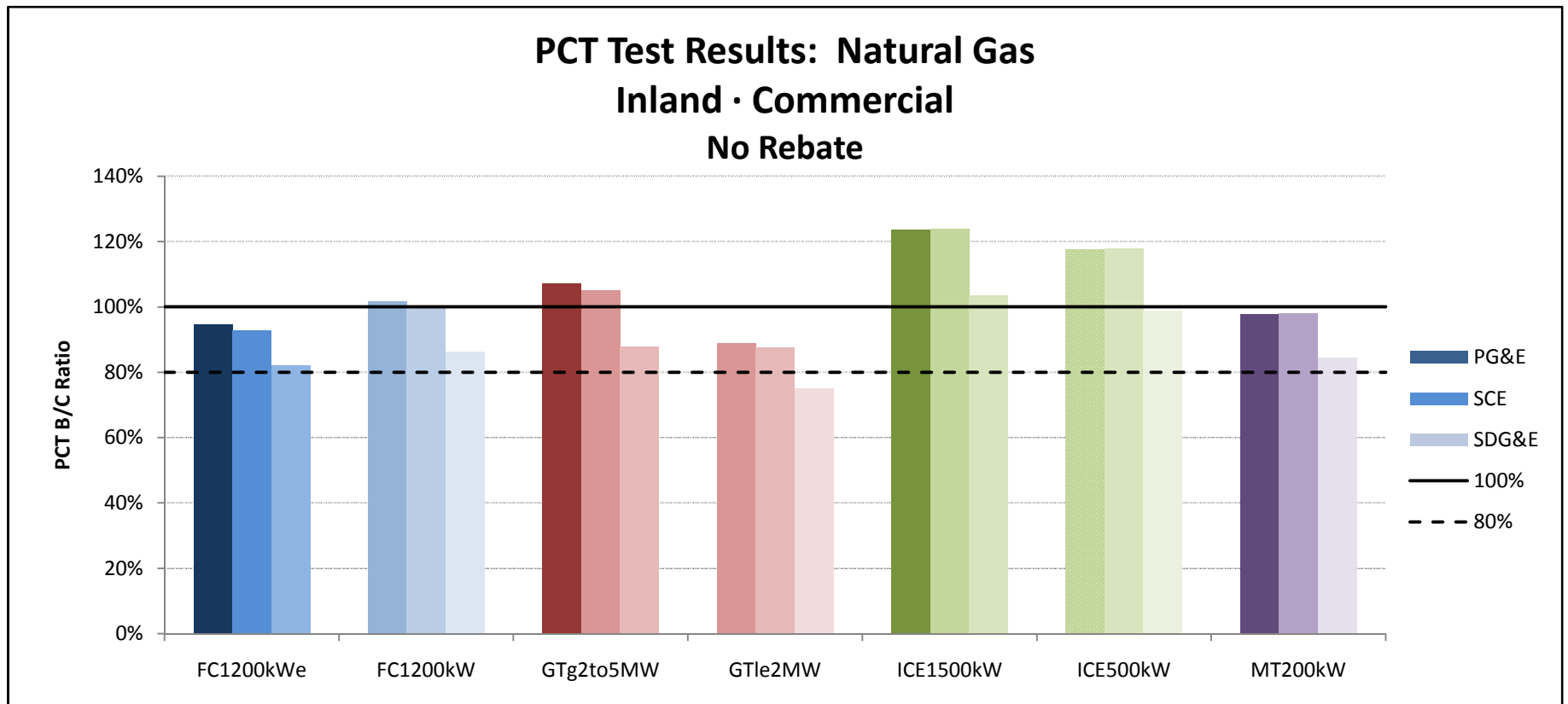

SGIP Cost Effectiveness Report
PCT Test Results

PCT Test Results: Non-Combustion
Statewide · Commercial

Technology	PG&E	SCE	SDG&E	Ave
WD1MW	163%	157%	136%	152%
ORC500kW	122%	121%	101%	115%
Storage25kW	46%	45%	42%	44%
Storage1MW	51%	50%	47%	49%

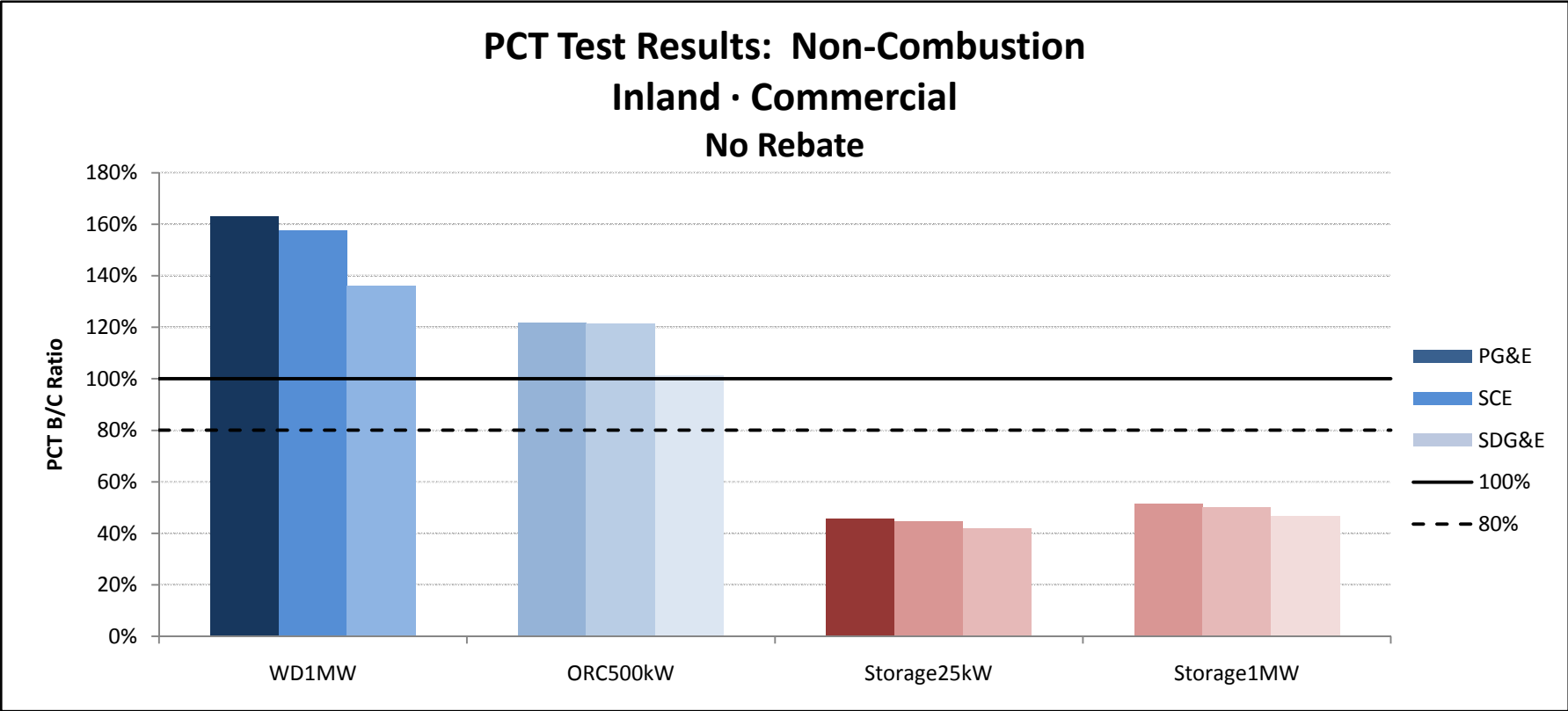

SGIP Cost Effectiveness Report

PCT Results

Government/Non-Profit

No Rebate

Technology	SGIPce System Size (kW)	PG&E		SCE		SDG&E		Statewide - Equal		Statewide - Elec Sales	
		PCT - 2010	MIRR	PCT - 2010	MIRR	PCT - 2010	MIRR	PCT - 2010	MIRR	PCT - 2010	MIRR
Wind Turbine											
- 1 MW	1,000	2.29	13.0%	2.16	12.6%	1.68	10.2%	2.04	11.9%	2.17	12.5%
Fuel Cell - Electric Only											
- Natural gas	1,200	0.81	-5.2%	0.78	-6.6%	0.56	-19.2%	0.72	-10.3%	0.77	-7.2%
- On site biogas	1,200	0.91	1.2%	0.88	0.0%	0.67	-7.8%	0.82	-2.2%	0.87	-0.2%
- Directed biogas	1,200	0.79	-7.9%	0.76	-9.3%	0.58	-100.0%	0.71	-39.1%	0.75	-17.7%
Fuel Cell - CHP (i.e., w/waste heat recovery)											
- Natural gas powered	1,200	1.04	5.0%	1.00	3.5%	0.74	-11.2%	0.93	-0.9%	0.99	2.7%
- On site biogas	1,200	1.24	8.1%	1.20	7.6%	0.94	1.7%	1.12	5.8%	1.19	7.3%
- Directed biogas	1,200	0.95	1.3%	0.92	-1.0%	0.71	-100.0%	0.86	-33.2%	0.91	-9.9%
Gas Turbine - CHP											
- Natural gas powered (1000 kW)	1,000	0.93	-2.8%	0.90	-6.1%	0.67	-100.0%	0.84	-36.3%	0.89	-14.0%
- On site biogas (1000 kW)	1,000	1.34	9.8%	1.32	9.5%	1.04	4.6%	1.23	8.0%	1.30	9.2%
- Directed biogas (1000 kW)	1,000	0.76	-100.0%	0.74	-100.0%	0.57	-100.0%	0.69	-100.0%	0.73	-100.0%
- Natural gas powered (3500 kW)	3,500	1.28	13.0%	1.24	12.3%	0.93	-6.4%	1.15	6.3%	1.23	10.7%
- On site biogas (3500 kW)	3,500	2.06	15.7%	2.02	15.5%	1.60	12.8%	1.89	14.7%	1.99	15.3%
- Directed biogas (3500 kW)	3,500	1.02	5.9%	1.00	3.6%	0.78	-100.0%	0.93	-30.2%	0.99	-5.7%
Microturbine - CHP											
- Natural gas powered	200	1.20	11.3%	1.20	11.4%	0.94	-4.3%	1.12	6.2%	1.18	9.8%
- On site biogas	200	0.89	0.0%	0.89	0.3%	0.73	-6.6%	0.84	-2.1%	0.88	-0.5%
- Directed biogas	200	0.94	-7.2%	0.94	-6.7%	0.76	-100.0%	0.88	-38.0%	0.92	-16.3%
IC Engine - CHP											
- Natural gas powered (500 kW)	500	1.51	16.2%	1.51	16.2%	1.15	10.6%	1.39	14.3%	1.47	15.6%
- On site biogas (500 kW)	500	1.39	9.4%	1.40	9.5%	1.13	6.2%	1.31	8.4%	1.37	9.1%
- Directed biogas (500 kW)	500	1.17	12.6%	1.18	12.7%	0.93	-7.1%	1.09	6.1%	1.15	10.7%
- Natural gas powered (1500 kW)	1,500	1.62	17.7%	1.62	17.7%	1.24	13.0%	1.50	16.1%	1.58	17.2%
- On site biogas (1500 kW)	1,500	2.97	19.0%	2.99	19.1%	2.43	17.2%	2.80	18.4%	2.93	18.9%
- Directed biogas (1500 kW)	1,500	1.23	14.5%	1.23	14.6%	0.98	2.1%	1.15	10.4%	1.21	13.3%
Organic Rankine Cycle											
	500	1.67	10.0%	1.66	9.9%	1.20	6.3%	1.51	8.7%	1.62	9.6%
Storage											
- Med storage	25	0.24	-100.0%	0.22	-100.0%	0.18	-100.0%	0.21	-100.0%	0.23	-100.0%
- Larger storage	1,000	0.33	-100.0%	0.31	-100.0%	0.25	-100.0%	0.30	-100.0%	0.31	-100.0%

SGIP Cost Effectiveness Report

PCT Results

Residential

No Rebate

Technology	SGIPce System Size (kW)	PG&E		SCE		SDG&E		Statewide - Equal		Statewide - Elec Sales	
		PCT - 2010	MIRR	PCT - 2010	MIRR	PCT - 2010	MIRR	PCT - 2010	MIRR	PCT - 2010	MIRR
Wind Turbine											
- 10 kW	10	1.16	7.2%	1.37	9.1%	1.16	7.2%	1.23	7.8%	1.25	8.0%
Fuel Cell - Electric Only											
- Natural gas powered	5	0.59	-4.1%	0.86	1.3%	0.62	-3.6%	0.69	-2.1%	0.71	-1.6%
Storage											
- Med storage	25	0.28	-100.0%	0.33	-100.0%	0.28	-100.0%	0.30	-100.0%	0.30	-100.0%

SGIP Cost Effectiveness Report

PCT Results

Commercial

w/ Actual EPBB Rebate

Technology	SGIPce System Size (kW)	PG&E		SCE		SDG&E		Statewide - Equal		Statewide - Elec Sales	
		PCT - 2010	MIRR	PCT - 2010	MIRR	PCT - 2010	MIRR	PCT - 2010	MIRR	PCT - 2010	MIRR
Wind Turbine											
- 1 MW	1,000	2.00	16.4%	1.94	16.2%	1.73	15.3%	1.89	16.0%	1.94	16.2%
Fuel Cell - Electric Only											
- Natural gas	1,200	1.04	11.0%	1.02	10.7%	0.91	9.1%	0.99	10.3%	1.02	10.7%
- On site biogas	1,200	1.15	12.2%	1.14	12.1%	1.04	10.9%	1.11	11.7%	1.13	12.0%
- Directed biogas	1,200	1.06	11.5%	1.05	11.3%	0.95	9.8%	1.02	10.9%	1.05	11.2%
Fuel Cell - CHP (i.e., w/waste heat recovery)											
- Natural gas powered	1,200	1.13	12.5%	1.10	12.2%	0.97	10.0%	1.07	11.6%	1.10	12.1%
- On site biogas	1,200	1.31	13.9%	1.29	13.8%	1.17	12.6%	1.26	13.4%	1.29	13.7%
- Directed biogas	1,200	1.13	13.2%	1.11	12.7%	1.00	10.7%	1.08	12.2%	1.11	12.7%
Gas Turbine - CHP											
- Natural gas powered (1000 kW)	1,000	0.89	6.3%	0.88	5.7%	0.75	1.2%	0.84	4.4%	0.87	5.5%
- On site biogas (1000 kW)	1,000	1.06	10.9%	1.05	10.7%	0.91	8.3%	1.01	9.9%	1.04	10.5%
- Directed biogas (1000 kW)	1,000	0.81	0.0%	0.80	-0.5%	0.71	-5.4%	0.77	-2.0%	0.80	-0.8%
- Natural gas powered (3500 kW)	3,500	1.07	12.2%	1.05	11.6%	0.88	4.5%	1.00	9.4%	1.04	11.2%
- On site biogas (3500 kW)	3,500	1.40	14.8%	1.38	14.6%	1.17	12.4%	1.32	14.0%	1.37	14.5%
- Directed biogas (3500 kW)	3,500	0.95	6.8%	0.94	5.8%	0.81	-3.9%	0.90	2.9%	0.93	5.3%
Microturbine - CHP											
- Natural gas powered	200	0.98	9.2%	0.98	9.3%	0.84	3.1%	0.93	7.2%	0.97	8.7%
- On site biogas	200	0.82	7.0%	0.83	7.0%	0.75	5.7%	0.80	6.6%	0.82	6.9%
- Directed biogas	200	0.87	0.9%	0.87	1.0%	0.77	-5.8%	0.84	-1.3%	0.86	0.3%
IC Engine - CHP											
- Natural gas powered (500 kW)	500	1.18	14.5%	1.18	14.6%	0.99	9.6%	1.11	12.9%	1.16	14.1%
- On site biogas (500 kW)	500	1.06	10.7%	1.07	10.8%	0.94	9.2%	1.03	10.2%	1.05	10.6%
- Directed biogas (500 kW)	500	1.02	11.0%	1.02	11.1%	0.89	1.6%	0.98	7.9%	1.01	10.1%
- Natural gas powered (1500 kW)	1,500	1.24	15.9%	1.24	15.9%	1.03	11.3%	1.17	14.4%	1.22	15.4%
- On site biogas (1500 kW)	1,500	1.81	17.4%	1.82	17.5%	1.54	15.8%	1.72	16.9%	1.79	17.3%
- Directed biogas (1500 kW)	1,500	1.05	12.6%	1.06	12.7%	0.92	3.0%	1.01	9.4%	1.04	11.7%
Organic Rankine Cycle	500	1.22	11.8%	1.21	11.8%	1.01	10.1%	1.15	11.2%	1.19	11.6%
Storage											
- Med storage	25	0.58	1.8%	0.58	1.9%	0.55	2.0%	0.57	1.9%	0.58	1.9%
- Larger storage	1,000	0.69	4.6%	0.69	4.7%	0.67	4.8%	0.68	4.7%	0.69	4.7%

SGIP Cost Effectiveness Report

PCT Results

Government/Non-Profit

w/ Actual EPBB Rebate

Technology	SGIPce System Size (kW)	PG&E		SCE		SDG&E		Statewide - Equal		Statewide - Elec Sales	
		PCT - 2010	MIRR	PCT - 2010	MIRR	PCT - 2010	MIRR	PCT - 2010	MIRR	PCT - 2010	MIRR
Wind Turbine											
- 1 MW	1,000	2.86	21.8%	2.73	21.4%	2.25	19.4%	2.61	20.9%	2.74	21.4%
Fuel Cell - Electric Only											
- Natural gas	1,200	0.94	0.1%	0.90	-2.4%	0.68	-17.8%	0.84	-6.7%	0.90	-2.8%
- On site biogas	1,200	1.13	7.3%	1.10	6.6%	0.89	-1.6%	1.04	4.1%	1.09	6.1%
- Directed biogas	1,200	0.98	2.1%	0.95	-0.5%	0.76	-100.0%	0.90	-32.8%	0.94	-9.3%
Fuel Cell - CHP (i.e., w/waste heat recovery)											
- Natural gas powered	1,200	1.19	10.1%	1.14	9.1%	0.88	-7.8%	1.07	3.8%	1.14	7.9%
- On site biogas	1,200	1.51	14.7%	1.47	14.3%	1.21	10.5%	1.40	13.2%	1.46	14.1%
- Directed biogas	1,200	1.16	13.8%	1.13	12.7%	0.92	-22.5%	1.07	1.3%	1.12	9.7%
Gas Turbine - CHP											
- Natural gas powered (1000 kW)	1,000	0.93	-2.8%	0.90	-6.1%	0.67	-100.0%	0.84	-36.3%	0.89	-14.0%
- On site biogas (1000 kW)	1,000	1.34	9.8%	1.32	9.5%	1.04	4.6%	1.23	8.0%	1.30	9.2%
- Directed biogas (1000 kW)	1,000	0.76	-100.0%	0.74	-100.0%	0.57	-100.0%	0.69	-100.0%	0.73	-100.0%
- Natural gas powered (3500 kW)	3,500	1.28	13.0%	1.24	12.3%	0.93	-6.4%	1.15	6.3%	1.23	10.7%
- On site biogas (3500 kW)	3,500	2.06	15.7%	2.02	15.5%	1.60	12.8%	1.89	14.7%	1.99	15.3%
- Directed biogas (3500 kW)	3,500	1.02	5.9%	1.00	3.6%	0.78	-100.0%	0.93	-30.2%	0.99	-5.7%
Microturbine - CHP											
- Natural gas powered	200	1.20	11.3%	1.20	11.4%	0.94	-4.3%	1.12	6.2%	1.18	9.8%
- On site biogas	200	0.89	0.0%	0.89	0.3%	0.73	-6.6%	0.84	-2.1%	0.88	-0.5%
- Directed biogas	200	0.94	-7.2%	0.94	-6.7%	0.76	-100.0%	0.88	-38.0%	0.92	-16.3%
IC Engine - CHP											
- Natural gas powered (500 kW)	500	1.51	16.2%	1.51	16.2%	1.15	10.6%	1.39	14.3%	1.47	15.6%
- On site biogas (500 kW)	500	1.39	9.4%	1.40	9.5%	1.13	6.2%	1.31	8.4%	1.37	9.1%
- Directed biogas (500 kW)	500	1.17	12.6%	1.18	12.7%	0.93	-7.1%	1.09	6.1%	1.15	10.7%
- Natural gas powered (1500 kW)	1,500	1.62	17.7%	1.62	17.7%	1.24	13.0%	1.50	16.1%	1.58	17.2%
- On site biogas (1500 kW)	1,500	2.97	19.0%	2.99	19.1%	2.43	17.2%	2.80	18.4%	2.93	18.9%
- Directed biogas (1500 kW)	1,500	1.23	14.5%	1.23	14.6%	0.98	2.1%	1.15	10.4%	1.21	13.3%
Organic Rankine Cycle	500	1.67	10.0%	1.66	9.9%	1.20	6.3%	1.51	8.7%	1.62	9.6%
Storage											
- Med storage	25	0.42	-100.0%	0.42	-100.0%	0.38	-100.0%	0.41	-100.0%	0.42	-100.0%
- Larger storage	1,000	0.59	-100.0%	0.59	-100.0%	0.55	-100.0%	0.58	-100.0%	0.58	-100.0%

SGIP Cost Effectiveness Report
PCT Results
Residential
w/ Actual EPBB Rebate

Technology	SGIPce System Size (kW)	PG&E		SCE		SDG&E		Statewide - Equal		Statewide - Elec Sales	
		PCT - 2010	MIRR	PCT - 2010	MIRR	PCT - 2010	MIRR	PCT - 2010	MIRR	PCT - 2010	MIRR
Wind Turbine											
- 10 kW	10	1.46	12.5%	1.67	14.2%	1.46	12.5%	1.53	13.1%	1.55	13.3%
Fuel Cell - Electric Only											
- Natural gas powered	5	0.64	-4.6%	0.91	2.1%	0.67	-4.1%	0.74	-2.2%	0.77	-1.5%
Storage											
- Med storage	25	0.45	-100.0%	0.49	-100.0%	0.46	-100.0%	0.47	-100.0%	0.47	-100.0%

SGIP Cost Effectiveness Report
 Participant Test Results (PCT)
 MIRR Graphs

FC1200kW w/ Directed BioGas - Government/Non-Profit - PG&E

	Rebate	MIRR	PCT-2010
▲ Actual Rebate - 2010	\$4.13	13.8%	1.16
■ No Rebate	\$0.00	1.3%	0.95
● Rebate to Reach MIRR of 10%	\$3.12	10.1%	1.11
● Rebate to Reach MIRR of 11%	\$3.41	11.1%	1.13
● Rebate to Reach MIRR of 12%	\$3.69	12.1%	1.14
● Rebate to Reach MIRR of 13%	\$3.95	13.0%	1.15
● Rebate to Reach MIRR of 14%	\$4.18	14.0%	1.17
● Rebate to Reach MIRR of 15%	\$4.39	15.0%	1.18

System Cost per Watt: \$5.87

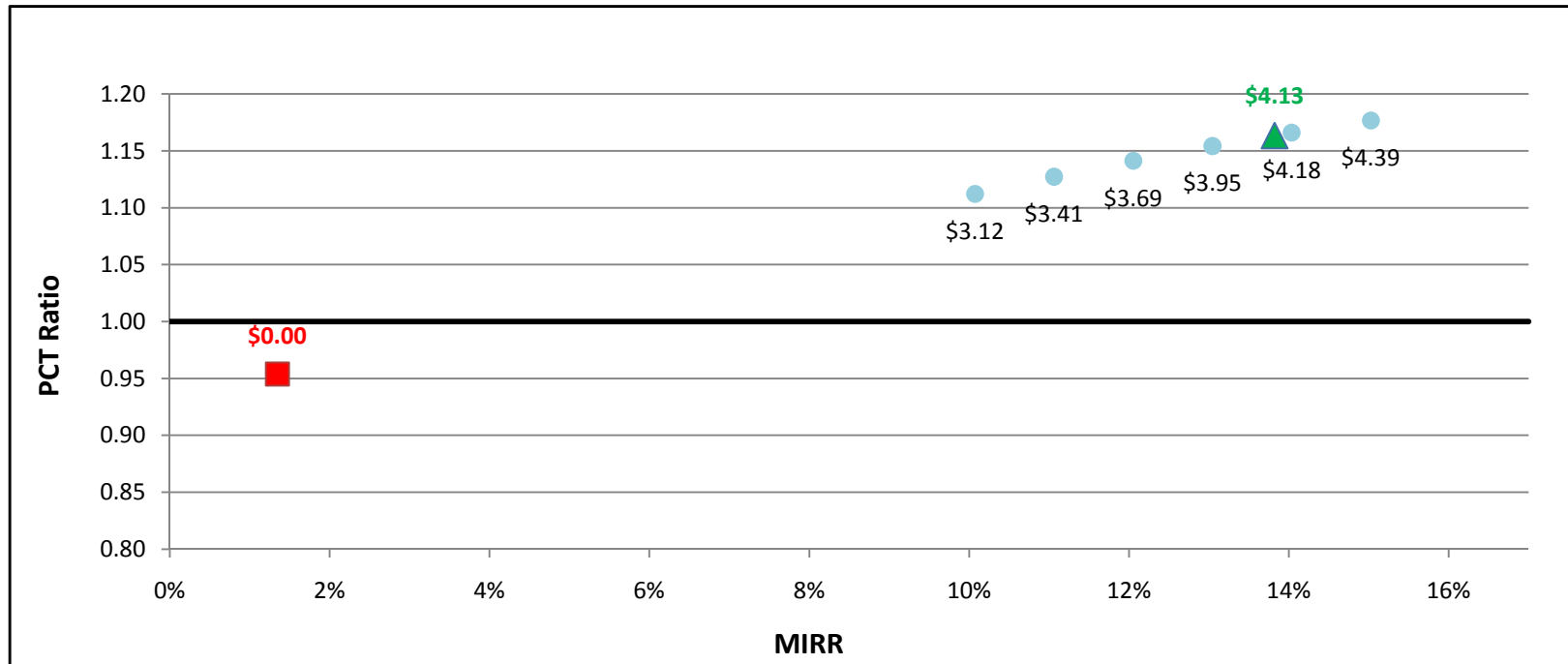

SGIP Cost Effectiveness Report
Participant Test Results (PCT)
MIRR Graphs

FC1200kW w/ Directed BioGas - Government/Non-Profit - SCE

	Rebate	MIRR	PCT-2010
▲ Actual Rebate - 2010	\$4.13	12.7%	1.13
■ No Rebate	\$0.00	-1.0%	0.92
● Rebate to Reach MIRR of 10%	\$3.48	10.0%	1.10
● Rebate to Reach MIRR of 11%	\$3.74	11.0%	1.11
● Rebate to Reach MIRR of 12%	\$3.98	12.0%	1.12
● Rebate to Reach MIRR of 13%	\$4.20	13.0%	1.13
● Rebate to Reach MIRR of 14%	\$4.40	14.0%	1.14
● Rebate to Reach MIRR of 15%	\$4.59	15.0%	1.15

System Cost per Watt: \$5.87

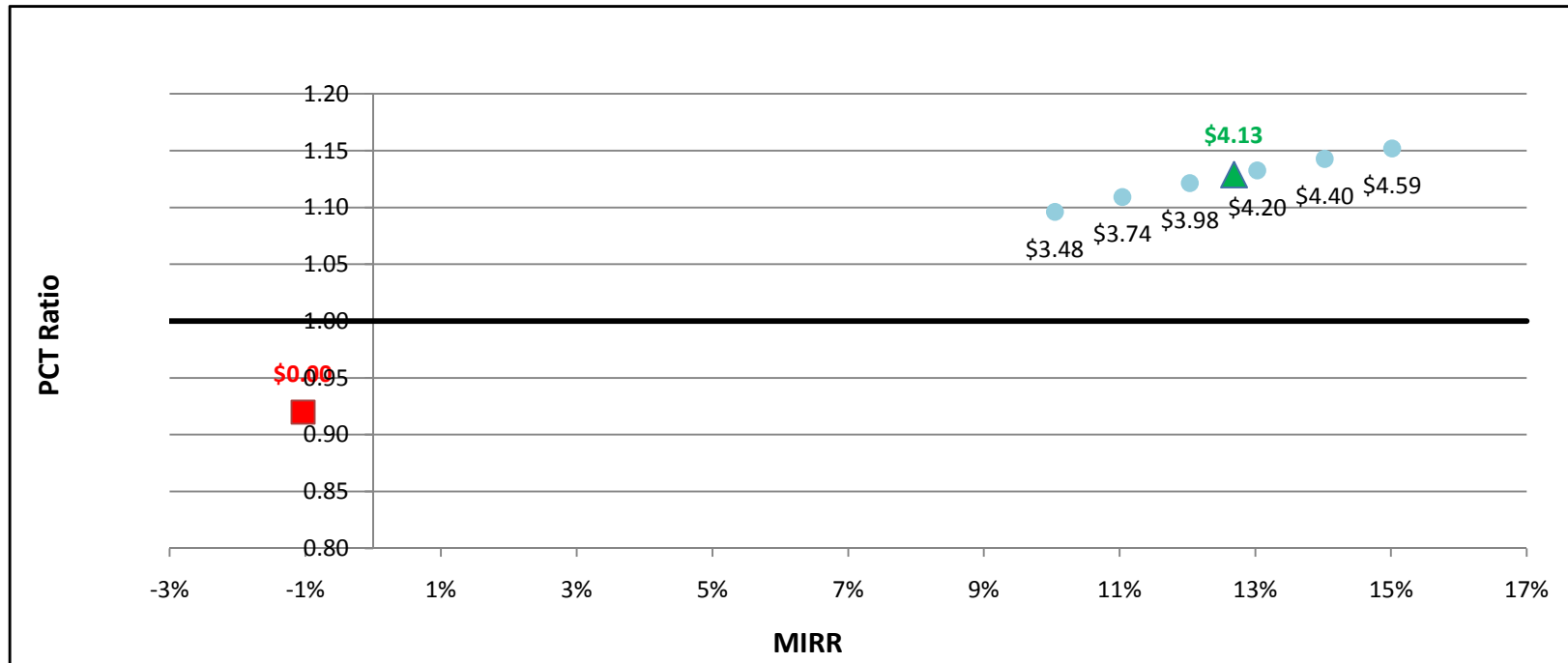

SGIP Cost Effectiveness Report
 Participant Test Results (PCT)
 MIRR Graphs

FC1200kW w/ Directed BioGas - Government/Non-Profit - SDG&E

	Rebate	MIRR	PCT-2010
▲ Actual Rebate - 2010	\$4.13	-22.5%	0.92
■ No Rebate	\$0.00	-100.0%	0.71
● Rebate to Reach MIRR of 10%	\$0.00	0.0%	0.00
● Rebate to Reach MIRR of 11%	\$0.00	0.0%	0.00
● Rebate to Reach MIRR of 12%	\$0.00	0.0%	0.00
● Rebate to Reach MIRR of 13%	\$0.00	0.0%	0.00
● Rebate to Reach MIRR of 14%	\$0.00	0.0%	0.00
● Rebate to Reach MIRR of 15%	\$0.00	0.0%	0.00

System Cost per Watt: \$5.87

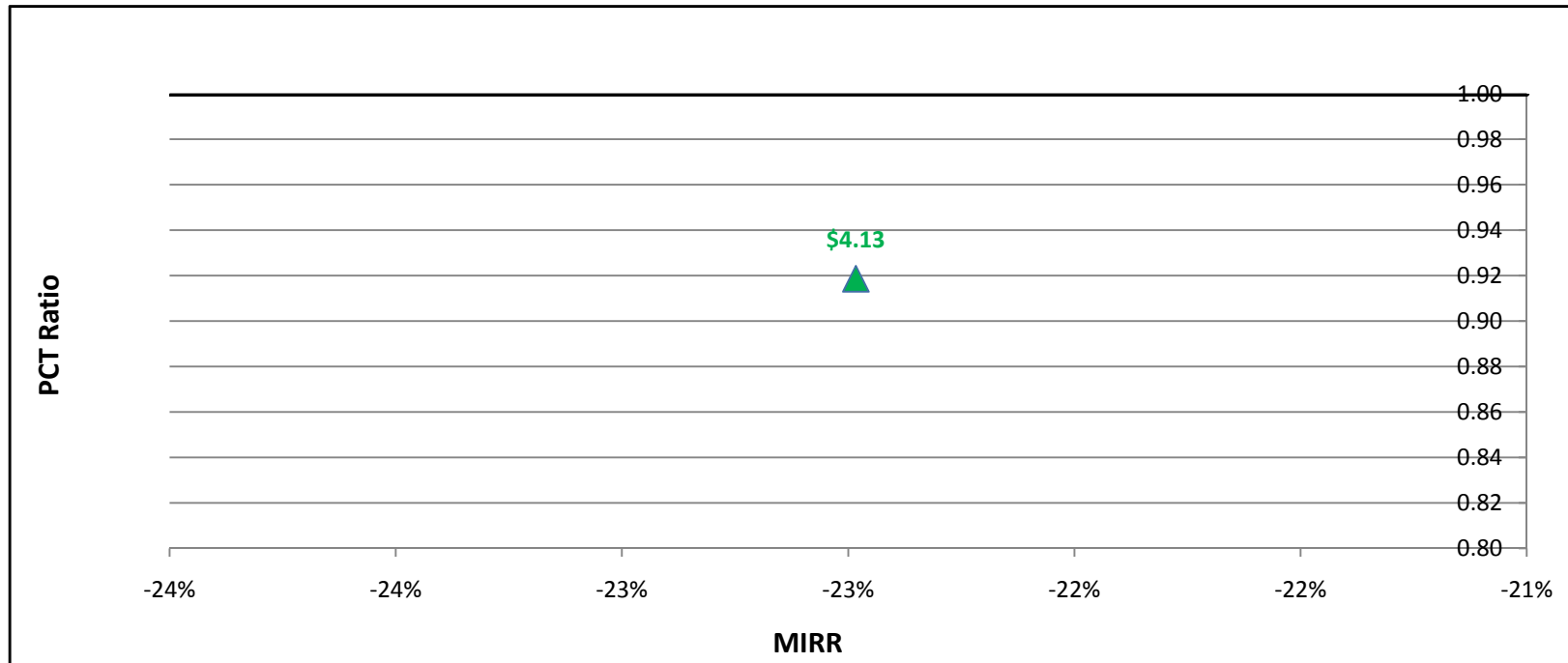

SGIP Cost Effectiveness Report
Participant Test Results (PCT)
MIRR Graphs

FC1200kW w/ Natural Gas - Government/Non-Profit - PG&E

	Rebate	MIRR	PCT-2010
▲ Actual Rebate - 2010	\$2.29	10.1%	1.19
■ No Rebate	\$0.00	5.0%	1.04
● Rebate to Reach MIRR of 10%	\$2.24	10.0%	1.18
● Rebate to Reach MIRR of 11%	\$2.64	11.0%	1.21
● Rebate to Reach MIRR of 12%	\$3.00	12.0%	1.23
● Rebate to Reach MIRR of 13%	\$3.37	13.1%	1.25
● Rebate to Reach MIRR of 14%	\$3.67	14.1%	1.27
● Rebate to Reach MIRR of 15%	\$3.94	15.1%	1.29

System Cost per Watt: \$5.87

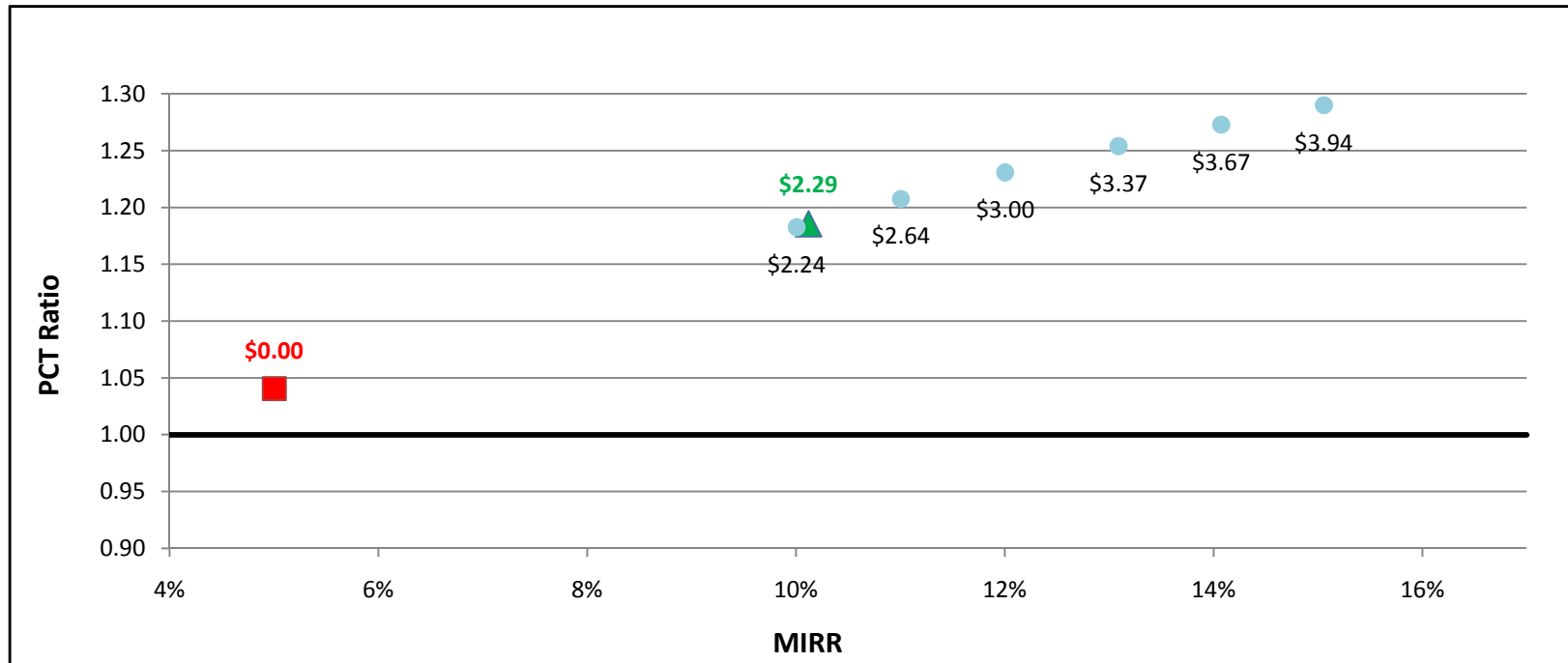

SGIP Cost Effectiveness Report
Participant Test Results (PCT)
MIRR Graphs

FC1200kW w/ Natural Gas - Government/Non-Profit - SCE

	Rebate	MIRR	PCT-2010
▲ Actual Rebate - 2010	\$2.29	9.1%	1.14
■ No Rebate	\$0.00	3.5%	1.00
● Rebate to Reach MIRR of 10%	\$2.62	10.0%	1.16
● Rebate to Reach MIRR of 11%	\$2.97	11.0%	1.19
● Rebate to Reach MIRR of 12%	\$3.33	12.1%	1.21
● Rebate to Reach MIRR of 13%	\$3.62	13.1%	1.23
● Rebate to Reach MIRR of 14%	\$3.89	14.1%	1.24
● Rebate to Reach MIRR of 15%	\$4.14	15.0%	1.26

System Cost per Watt: \$5.87

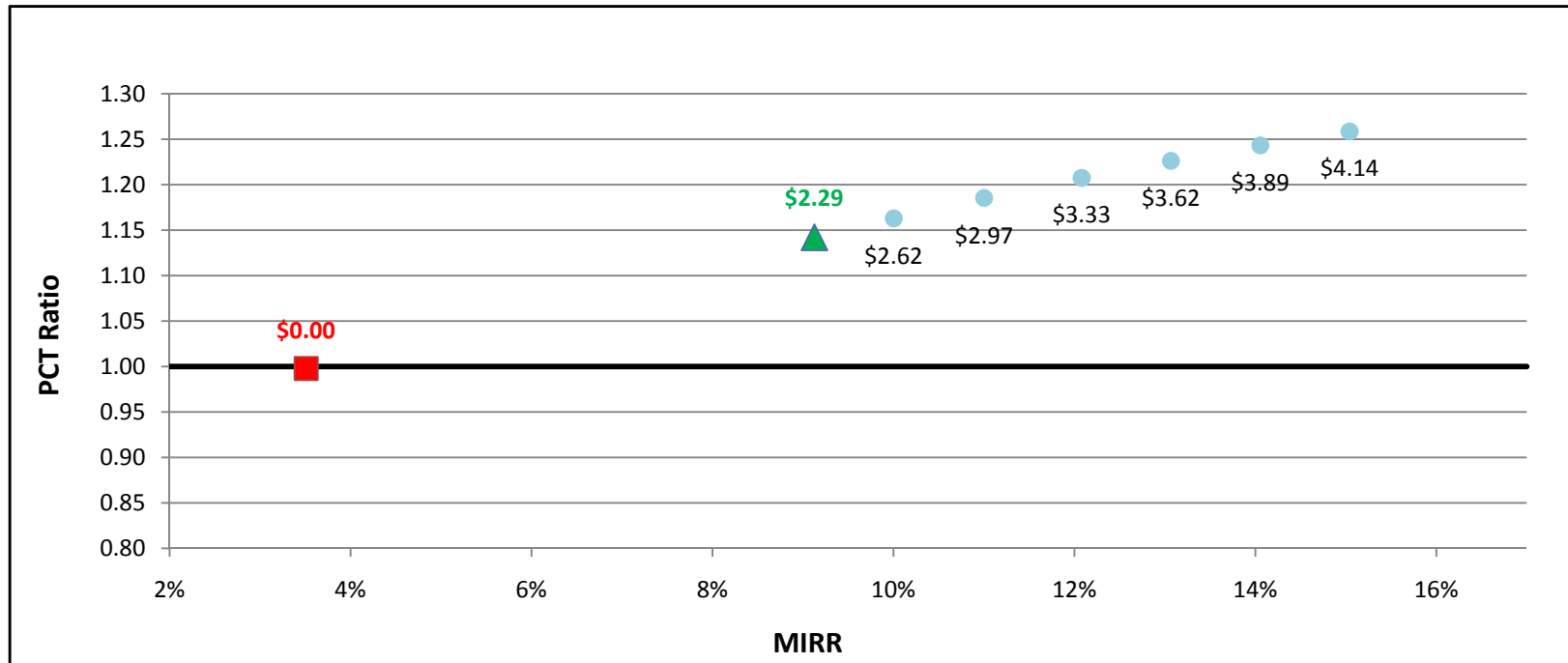

SGIP Cost Effectiveness Report
Participant Test Results (PCT)
MIRR Graphs

FC1200kW w/ Natural Gas - Government/Non-Profit - SDG&E

	Rebate	MIRR	PCT-2010
▲ Actual Rebate - 2010	\$2.29	-7.8%	0.88
■ No Rebate	\$0.00	-11.2%	0.74
● Rebate to Reach MIRR of 10%	\$4.95	10.1%	1.05
● Rebate to Reach MIRR of 11%	\$5.05	11.1%	1.05
● Rebate to Reach MIRR of 12%	\$5.14	12.0%	1.06
● Rebate to Reach MIRR of 13%	\$5.23	13.0%	1.06
● Rebate to Reach MIRR of 14%	\$5.30	14.0%	1.07
● Rebate to Reach MIRR of 15%	\$5.37	15.0%	1.07

System Cost per Watt: \$5.87

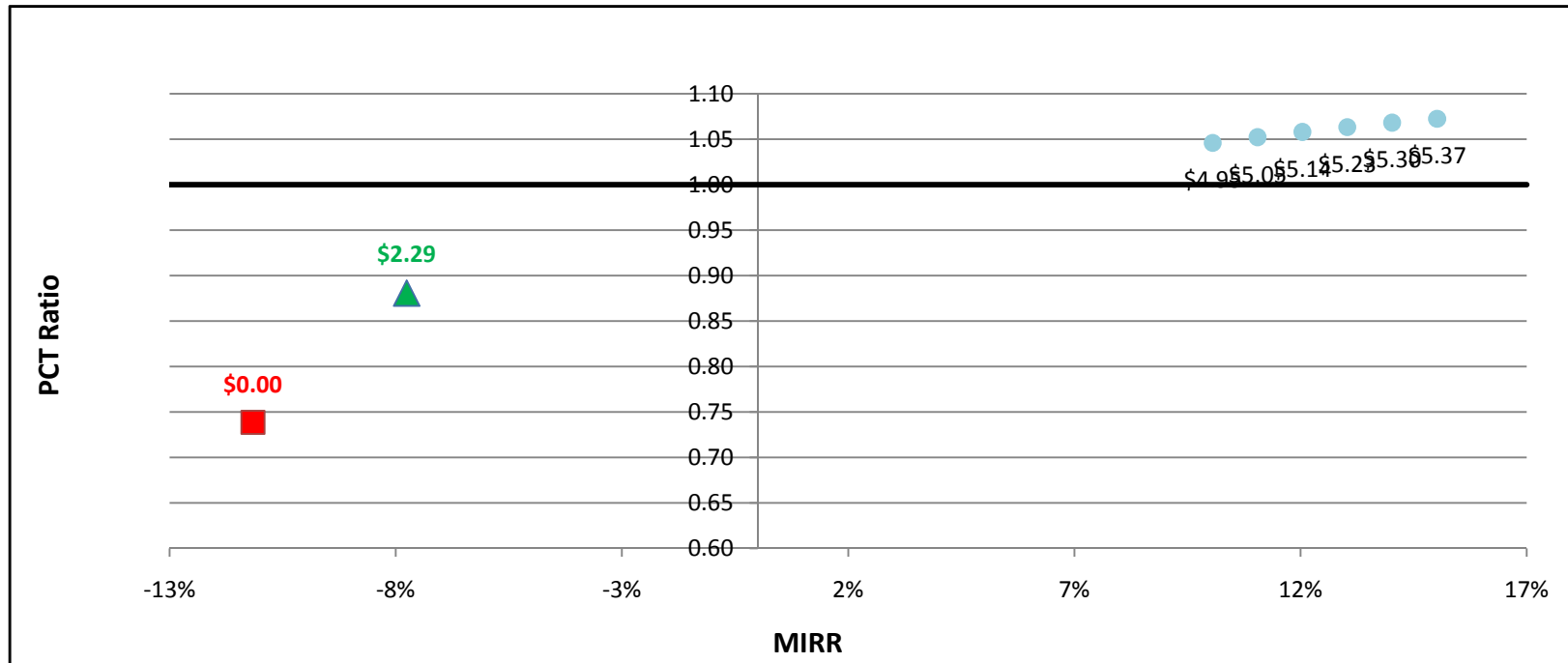

SGIP Cost Effectiveness Report
Participant Test Results (PCT)
MIRR Graphs

FC1200kW w/ On-Site BioGas - Government/Non-Profit - PG&E

	Rebate	MIRR	PCT-2010
▲ Actual Rebate - 2010	\$4.13	14.7%	1.51
■ No Rebate	\$0.00	8.1%	1.24
● Rebate to Reach MIRR of 10%	\$1.37	10.0%	1.33
● Rebate to Reach MIRR of 11%	\$2.05	11.0%	1.37
● Rebate to Reach MIRR of 12%	\$2.73	12.1%	1.42
● Rebate to Reach MIRR of 13%	\$3.27	13.0%	1.45
● Rebate to Reach MIRR of 14%	\$3.79	14.0%	1.49
● Rebate to Reach MIRR of 15%	\$4.26	15.0%	1.52

System Cost per Watt: \$6.08

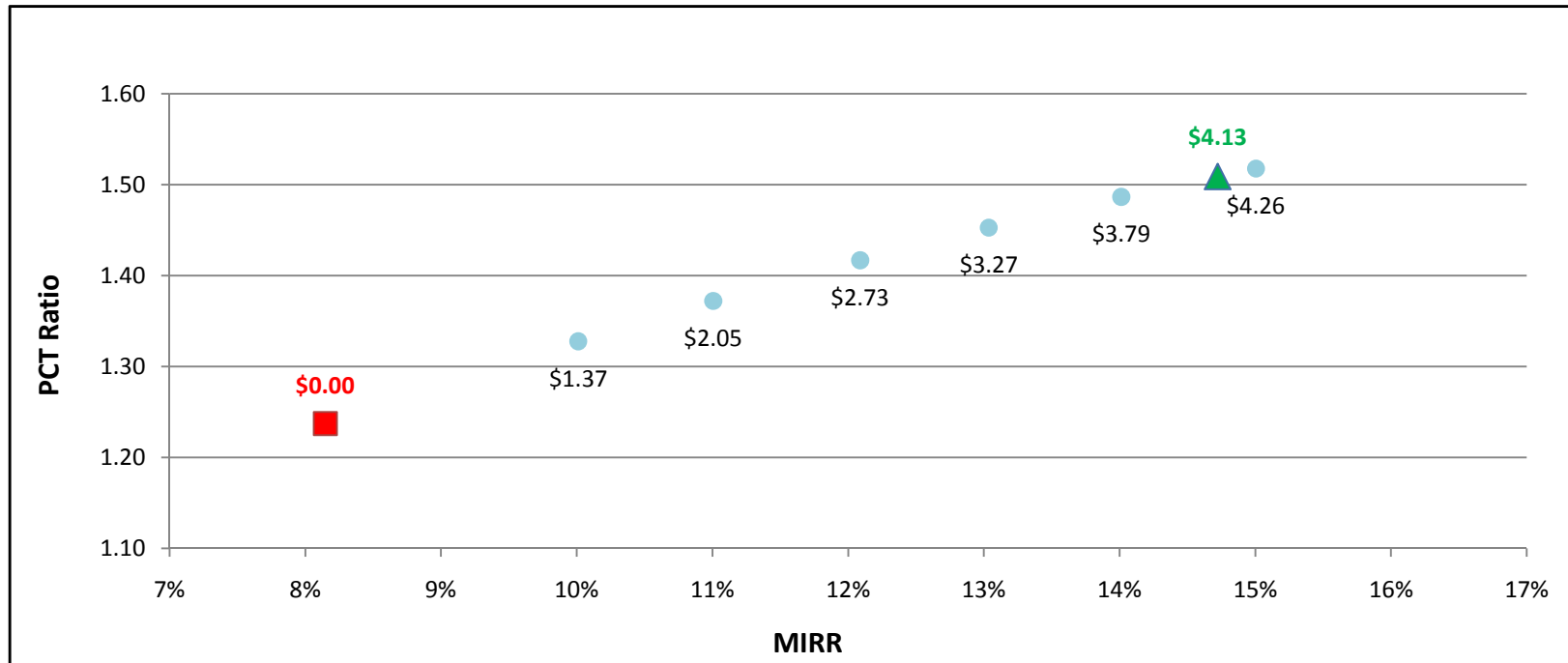

SGIP Cost Effectiveness Report
Participant Test Results (PCT)
MIRR Graphs

FC1200kW w/ On-Site BioGas - Government/Non-Profit - SCE

	Rebate	MIRR	PCT-2010
▲ Actual Rebate - 2010	\$4.13	14.3%	1.47
■ No Rebate	\$0.00	7.6%	1.20
● Rebate to Reach MIRR of 10%	\$1.71	10.0%	1.31
● Rebate to Reach MIRR of 11%	\$2.35	11.0%	1.35
● Rebate to Reach MIRR of 12%	\$2.98	12.1%	1.39
● Rebate to Reach MIRR of 13%	\$3.50	13.0%	1.43
● Rebate to Reach MIRR of 14%	\$3.99	14.0%	1.46
● Rebate to Reach MIRR of 15%	\$4.48	15.1%	1.49

System Cost per Watt: \$6.08

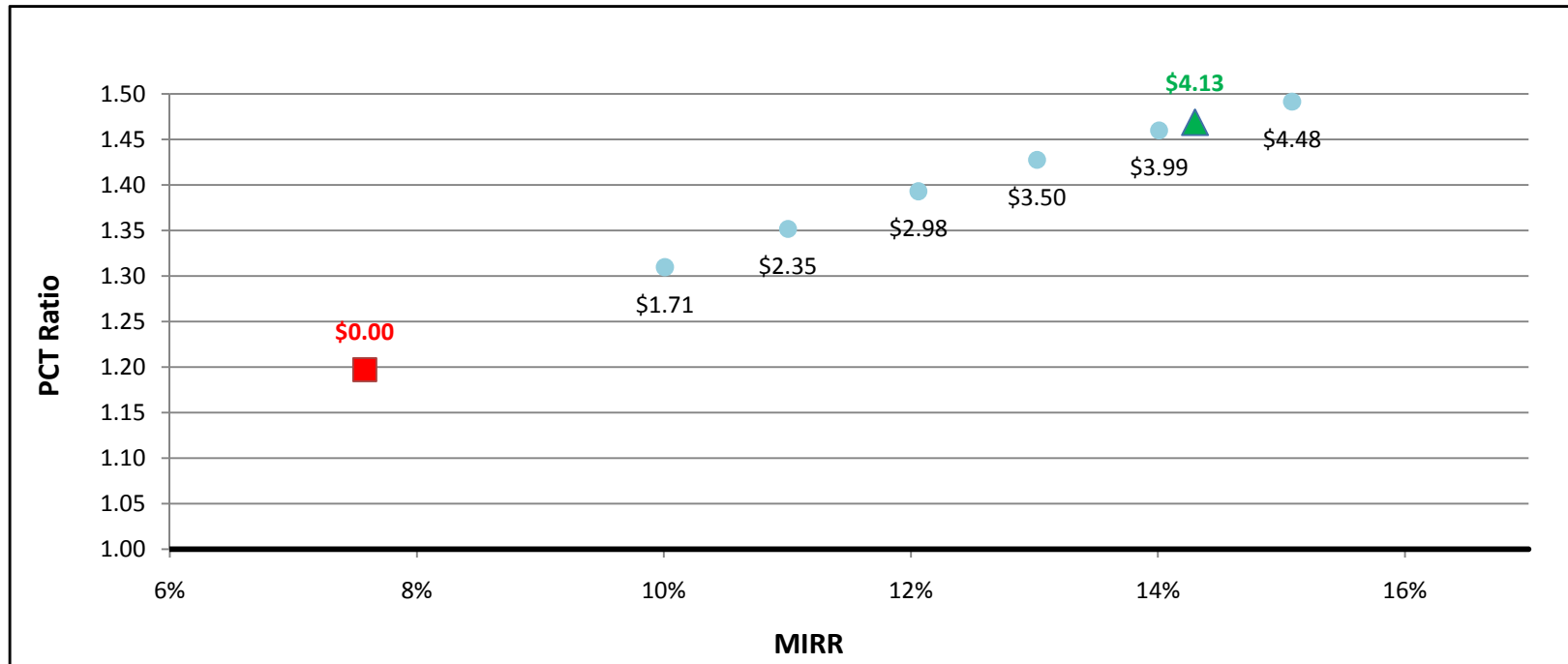

SGIP Cost Effectiveness Report
 Participant Test Results (PCT)
 MIRR Graphs

FC1200kW w/ On-Site BioGas - Government/Non-Profit - SDG&E

	Rebate	MIRR	PCT-2010
▲ Actual Rebate - 2010	\$4.13	10.5%	1.21
■ No Rebate	\$0.00	1.7%	0.94
● Rebate to Reach MIRR of 10%	\$3.92	10.0%	1.19
● Rebate to Reach MIRR of 11%	\$4.35	11.1%	1.22
● Rebate to Reach MIRR of 12%	\$4.70	12.0%	1.25
● Rebate to Reach MIRR of 13%	\$5.04	13.0%	1.27
● Rebate to Reach MIRR of 14%	\$5.36	14.0%	1.29
● Rebate to Reach MIRR of 15%	\$5.63	15.0%	1.31

System Cost per Watt: \$6.08

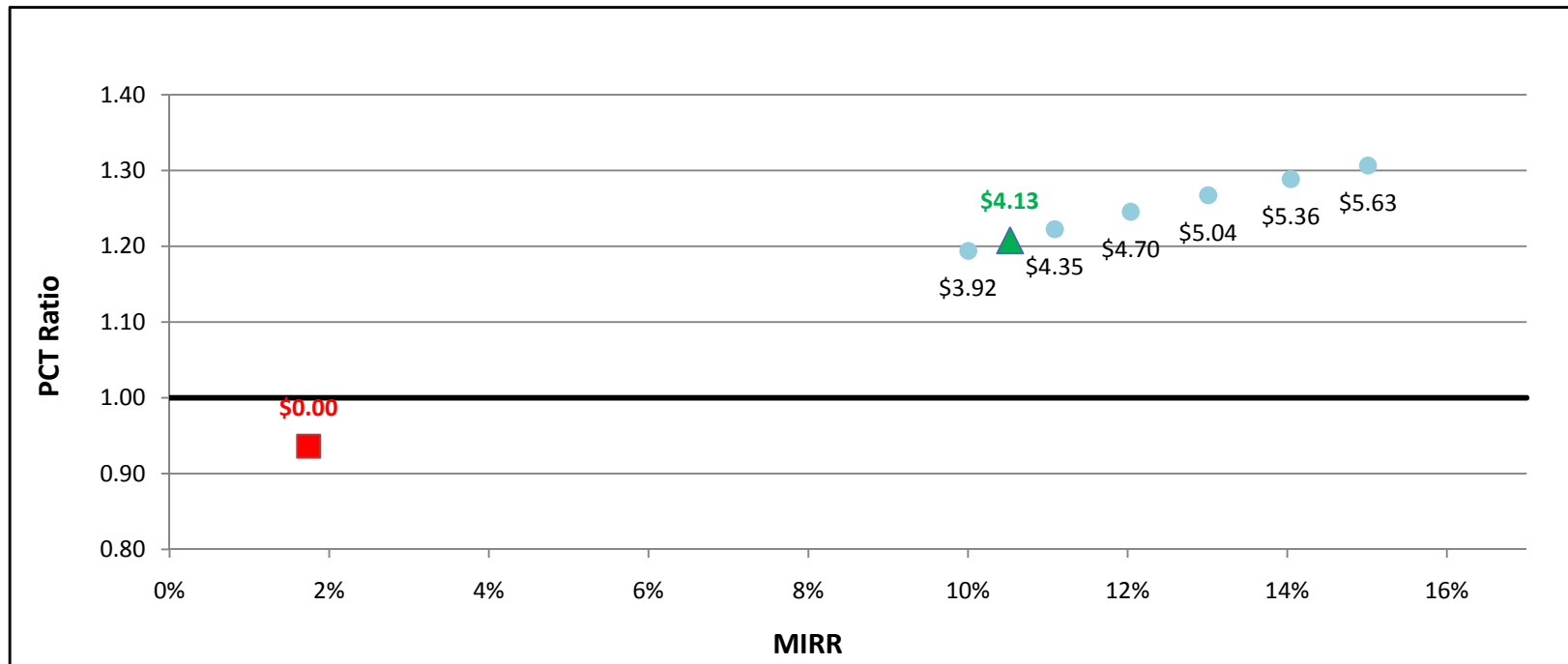

SGIP Cost Effectiveness Report
Participant Test Results (PCT)
MIRR Graphs

FC1200kW w/ Directed BioGas - Commercial - PG&E

	Rebate	MIRR	PCT-2010
▲ Actual Rebate - 2010	\$4.13	13.1%	1.13
■ No Rebate	\$0.00	9.6%	0.97
● Rebate to Reach MIRR of 10%	\$0.43	10.0%	0.99
● Rebate to Reach MIRR of 11%	\$1.37	11.0%	1.02
● Rebate to Reach MIRR of 12%	\$2.64	12.0%	1.07
● Rebate to Reach MIRR of 13%	\$4.04	13.0%	1.13
● Rebate to Reach MIRR of 14%	\$5.85	14.1%	1.20
● Rebate to Reach MIRR of 15%	\$0.00	0.0%	0.00

System Cost per Watt: \$5.87

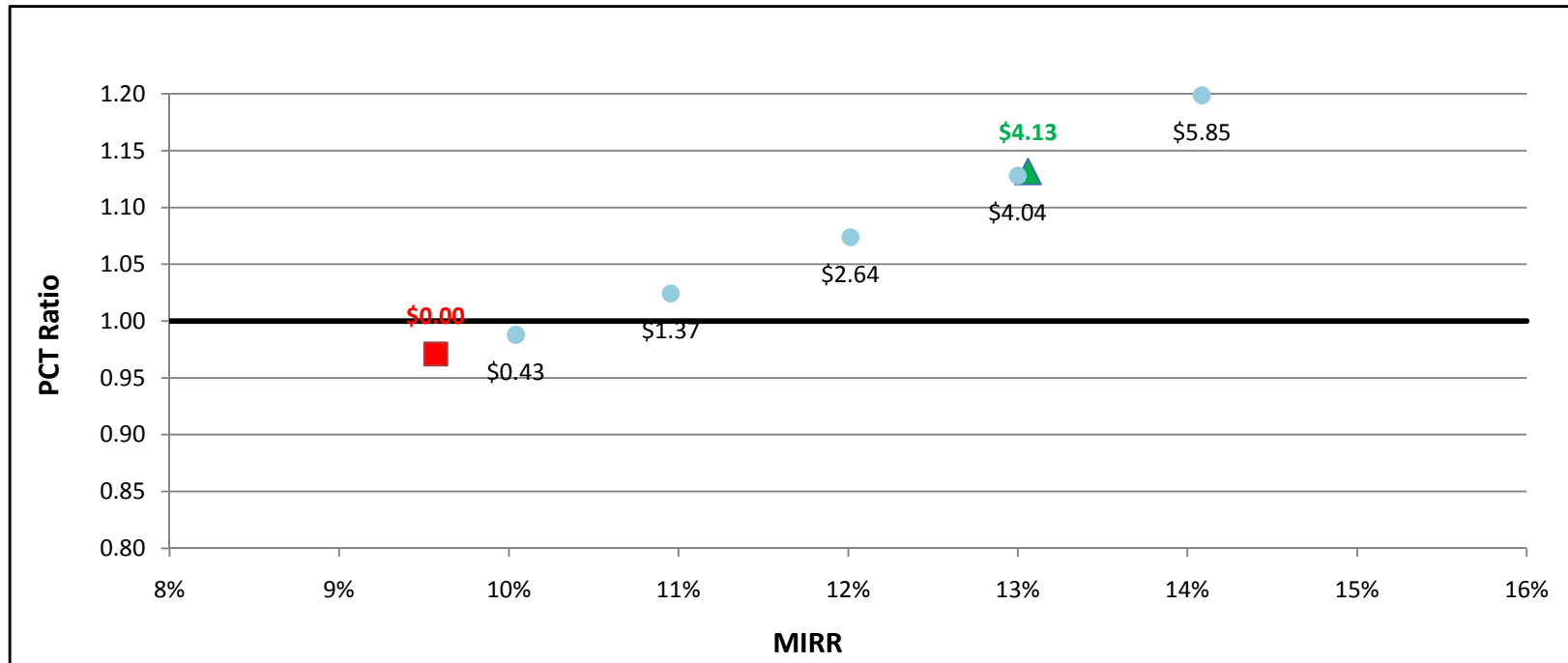

SGIP Cost Effectiveness Report
Participant Test Results (PCT)
MIRR Graphs

FC1200kW w/ Directed BioGas - Commercial - SCE

	Rebate	MIRR	PCT-2010
▲ Actual Rebate - 2010	\$4.13	12.7%	1.11
■ No Rebate	\$0.00	9.1%	0.95
● Rebate to Reach MIRR of 10%	\$0.81	10.0%	0.98
● Rebate to Reach MIRR of 11%	\$1.88	11.0%	1.03
● Rebate to Reach MIRR of 12%	\$2.99	11.9%	1.07
● Rebate to Reach MIRR of 13%	\$4.53	13.0%	1.13
● Rebate to Reach MIRR of 14%	\$0.00	0.0%	0.00
● Rebate to Reach MIRR of 15%	\$0.00	0.0%	0.00

System Cost per Watt: \$5.87

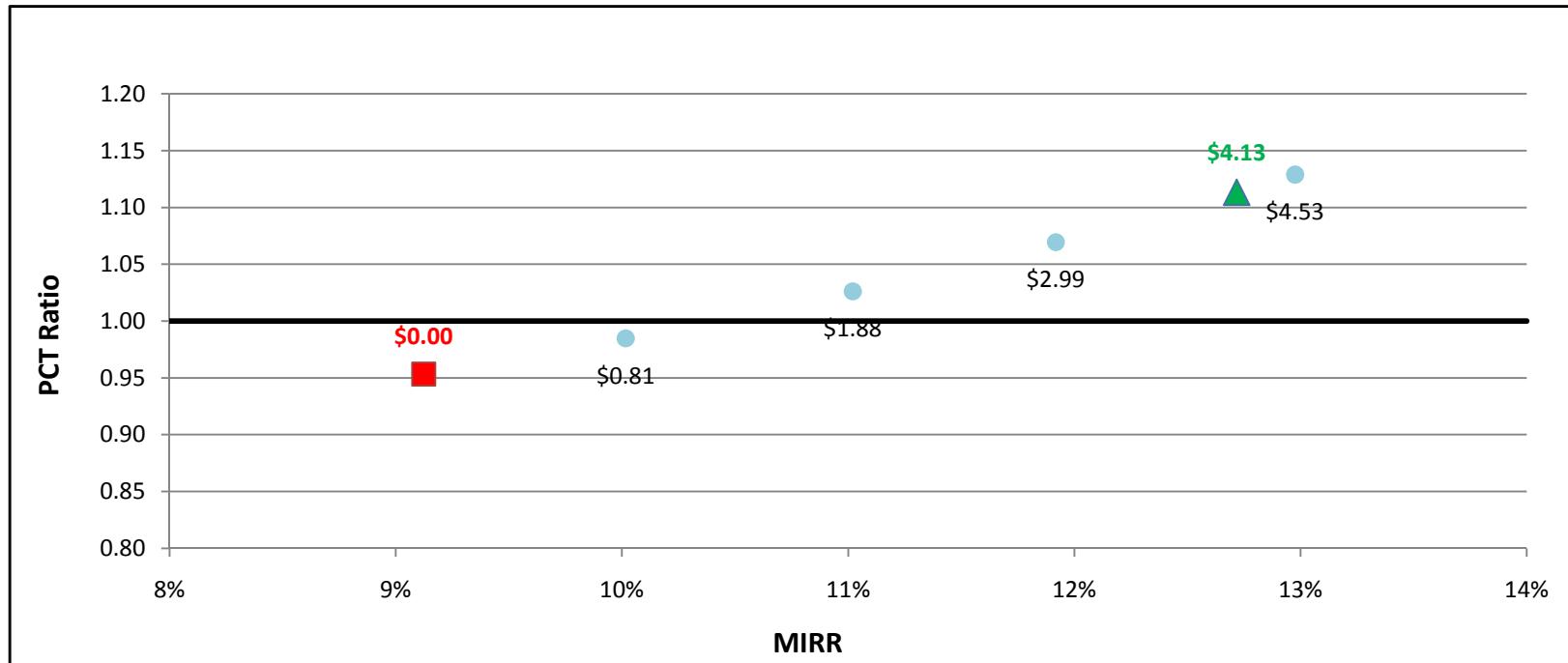

SGIP Cost Effectiveness Report
 Participant Test Results (PCT)
 MIRR Graphs

FC1200kW w/ Directed BioGas - Commercial - SDG&E

	Rebate	MIRR	PCT-2010
▲ Actual Rebate - 2010	\$4.13	10.7%	1.00
■ No Rebate	\$0.00	6.3%	0.84
● Rebate to Reach MIRR of 10%	\$3.21	9.9%	0.97
● Rebate to Reach MIRR of 11%	\$4.57	11.0%	1.02
● Rebate to Reach MIRR of 12%	\$0.00	0.0%	0.00
● Rebate to Reach MIRR of 13%	\$0.00	0.0%	0.00
● Rebate to Reach MIRR of 14%	\$0.00	0.0%	0.00
● Rebate to Reach MIRR of 15%	\$0.00	0.0%	0.00

System Cost per Watt: \$5.87

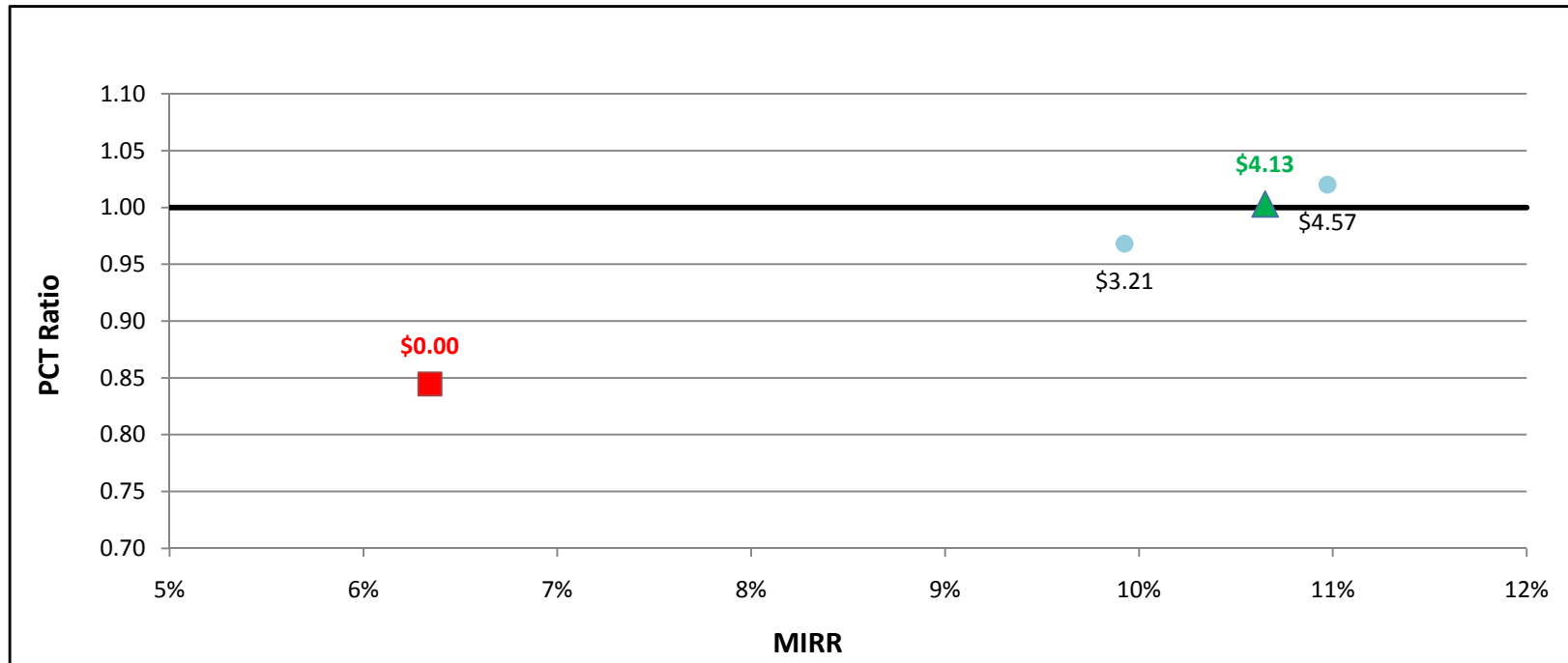

SGIP Cost Effectiveness Report
 Participant Test Results (PCT)
 MIRR Graphs

FC1200kW w/ Natural Gas - Commercial - PG&E

	Rebate	MIRR	PCT-2010
▲ Actual Rebate - 2010	\$2.29	12.5%	1.13
■ No Rebate	\$0.00	10.6%	1.02
● Rebate to Reach MIRR of 10%	\$0.00	0.0%	0.00
● Rebate to Reach MIRR of 11%	\$0.44	11.0%	1.04
● Rebate to Reach MIRR of 12%	\$1.70	12.1%	1.10
● Rebate to Reach MIRR of 13%	\$2.83	12.9%	1.15
● Rebate to Reach MIRR of 14%	\$4.53	14.0%	1.23
● Rebate to Reach MIRR of 15%	\$0.00	0.0%	0.00

System Cost per Watt: \$5.87

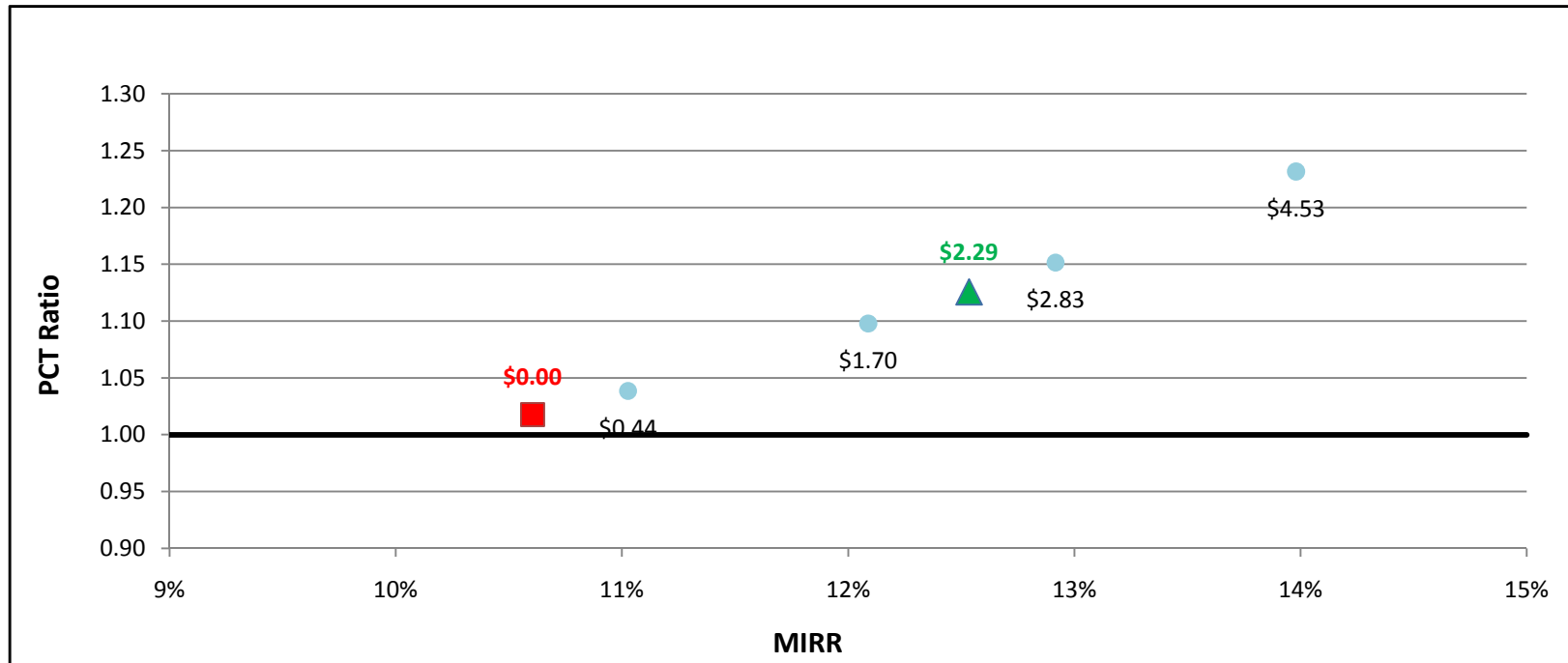

SGIP Cost Effectiveness Report
Participant Test Results (PCT)
MIRR Graphs

FC1200kW w/ Natural Gas - Commercial - SCE

	Rebate	MIRR	PCT-2010
▲ Actual Rebate - 2010	\$2.29	12.2%	1.10
■ No Rebate	\$0.00	10.2%	1.00
● Rebate to Reach MIRR of 10%	\$0.00	0.0%	0.00
● Rebate to Reach MIRR of 11%	\$0.82	11.0%	1.03
● Rebate to Reach MIRR of 12%	\$2.03	12.0%	1.09
● Rebate to Reach MIRR of 13%	\$3.32	13.0%	1.15
● Rebate to Reach MIRR of 14%	\$5.00	14.0%	1.23
● Rebate to Reach MIRR of 15%	\$0.00	0.0%	0.00

System Cost per Watt: \$5.87

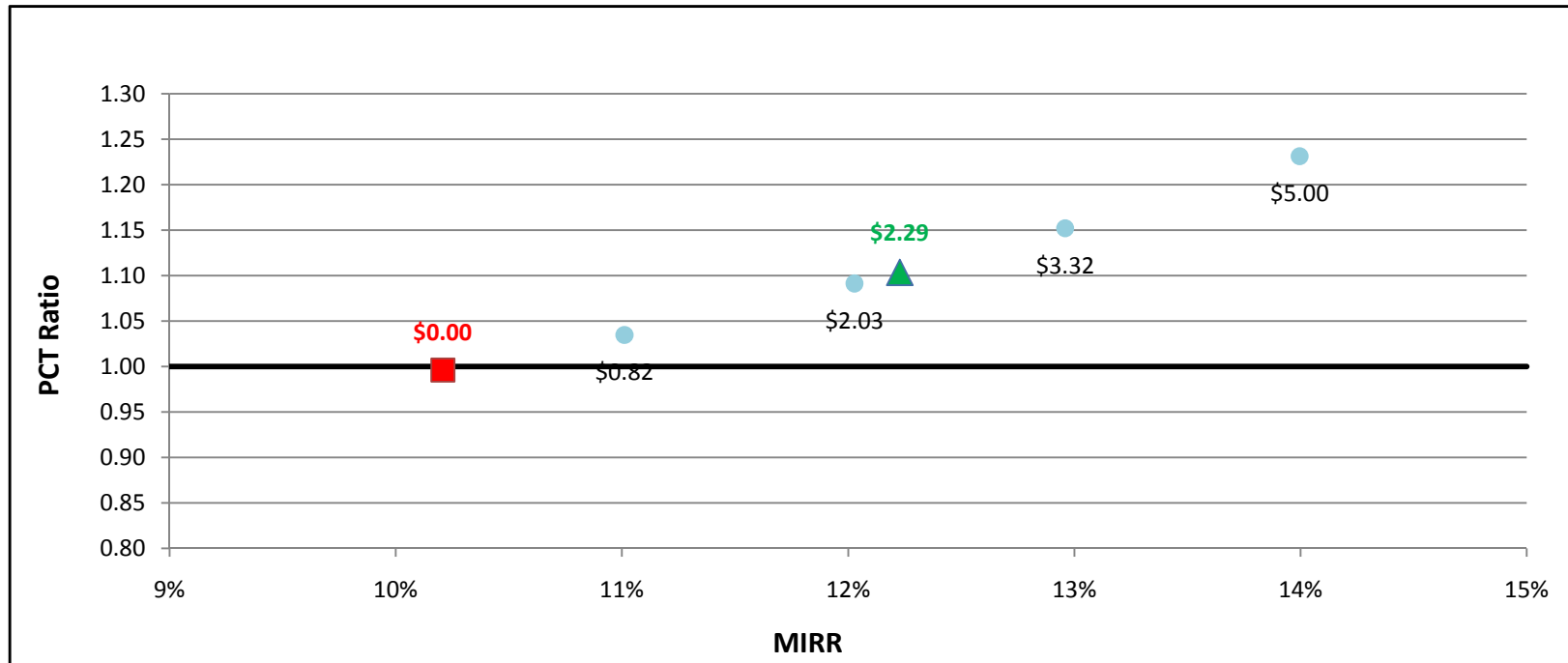

SGIP Cost Effectiveness Report
Participant Test Results (PCT)
MIRR Graphs

FC1200kW w/ Natural Gas - Commercial - SDG&E

	Rebate	MIRR	PCT-2010
▲ Actual Rebate - 2010	\$2.29	10.0%	0.97
■ No Rebate	\$0.00	7.6%	0.86
● Rebate to Reach MIRR of 10%	\$2.33	10.0%	0.97
● Rebate to Reach MIRR of 11%	\$3.48	11.0%	1.03
● Rebate to Reach MIRR of 12%	\$4.97	12.0%	1.09
● Rebate to Reach MIRR of 13%	\$0.00	0.0%	0.00
● Rebate to Reach MIRR of 14%	\$0.00	0.0%	0.00
● Rebate to Reach MIRR of 15%	\$0.00	0.0%	0.00

System Cost per Watt: \$5.87

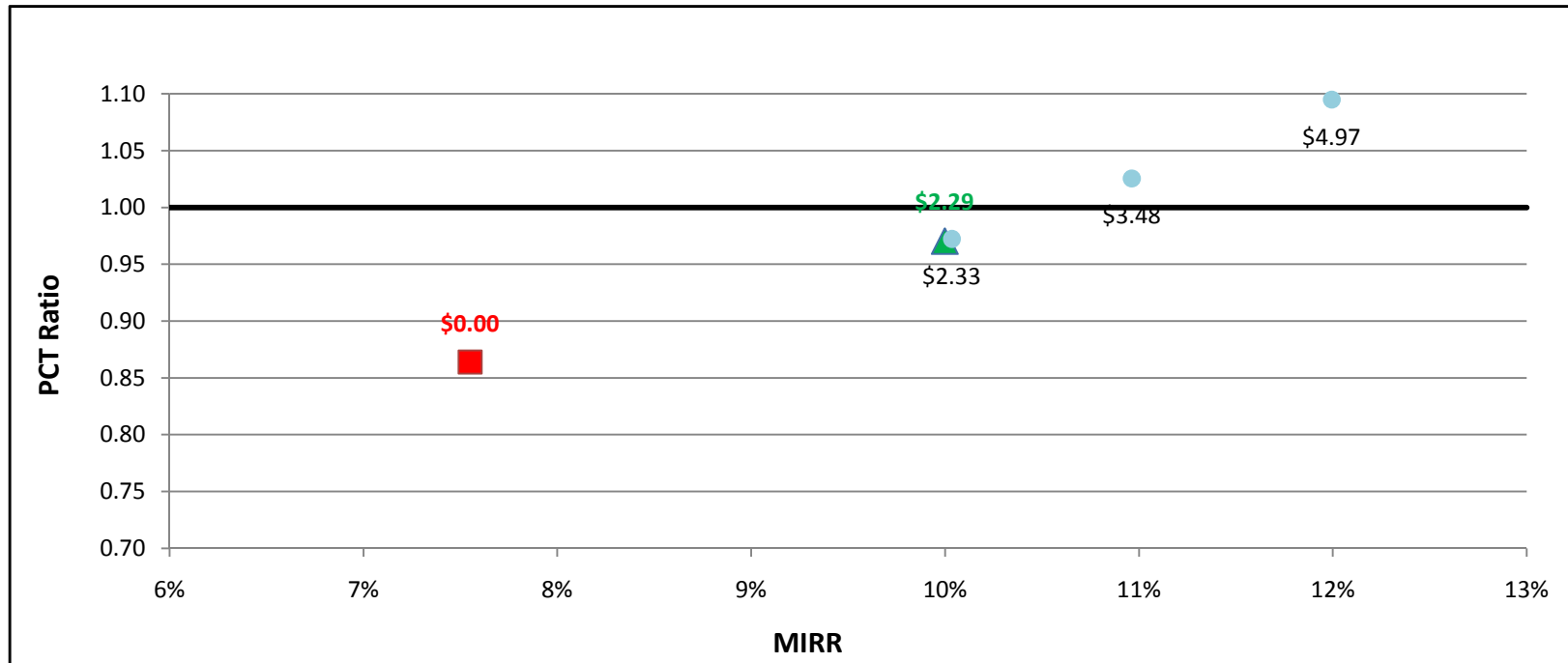

SGIP Cost Effectiveness Report
Participant Test Results (PCT)
MIRR Graphs

FC1200kW w/ On-Site BioGas - Commercial - PG&E

	Rebate	MIRR	PCT-2010
▲ Actual Rebate - 2010	\$4.13	13.9%	1.31
■ No Rebate	\$0.00	11.7%	1.12
● Rebate to Reach MIRR of 10%	\$0.00	0.0%	0.00
● Rebate to Reach MIRR of 11%	\$0.00	0.0%	0.00
● Rebate to Reach MIRR of 12%	\$0.46	12.0%	1.14
● Rebate to Reach MIRR of 13%	\$2.24	13.0%	1.22
● Rebate to Reach MIRR of 14%	\$4.25	14.0%	1.32
● Rebate to Reach MIRR of 15%	\$0.00	0.0%	0.00

System Cost per Watt: \$6.08

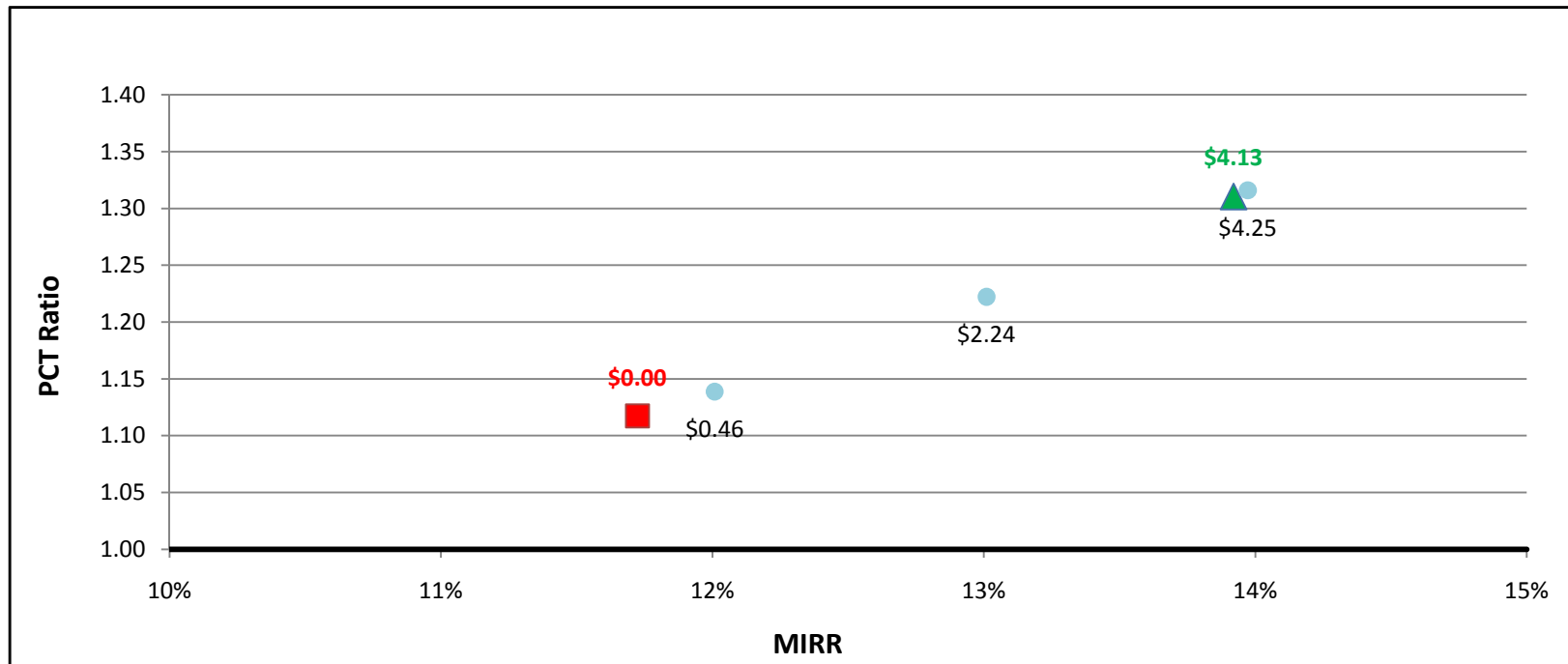

SGIP Cost Effectiveness Report
Participant Test Results (PCT)
MIRR Graphs

FC1200kW w/ On-Site BioGas - Commercial - SCE

	Rebate	MIRR	PCT-2010
▲ Actual Rebate - 2010	\$4.13	13.8%	1.29
■ No Rebate	\$0.00	11.5%	1.10
● Rebate to Reach MIRR of 10%	\$0.00	0.0%	0.00
● Rebate to Reach MIRR of 11%	\$0.00	0.0%	0.00
● Rebate to Reach MIRR of 12%	\$0.64	11.9%	1.13
● Rebate to Reach MIRR of 13%	\$2.39	12.9%	1.21
● Rebate to Reach MIRR of 14%	\$4.62	14.0%	1.31
● Rebate to Reach MIRR of 15%	\$0.00	0.0%	0.00

System Cost per Watt: \$6.08

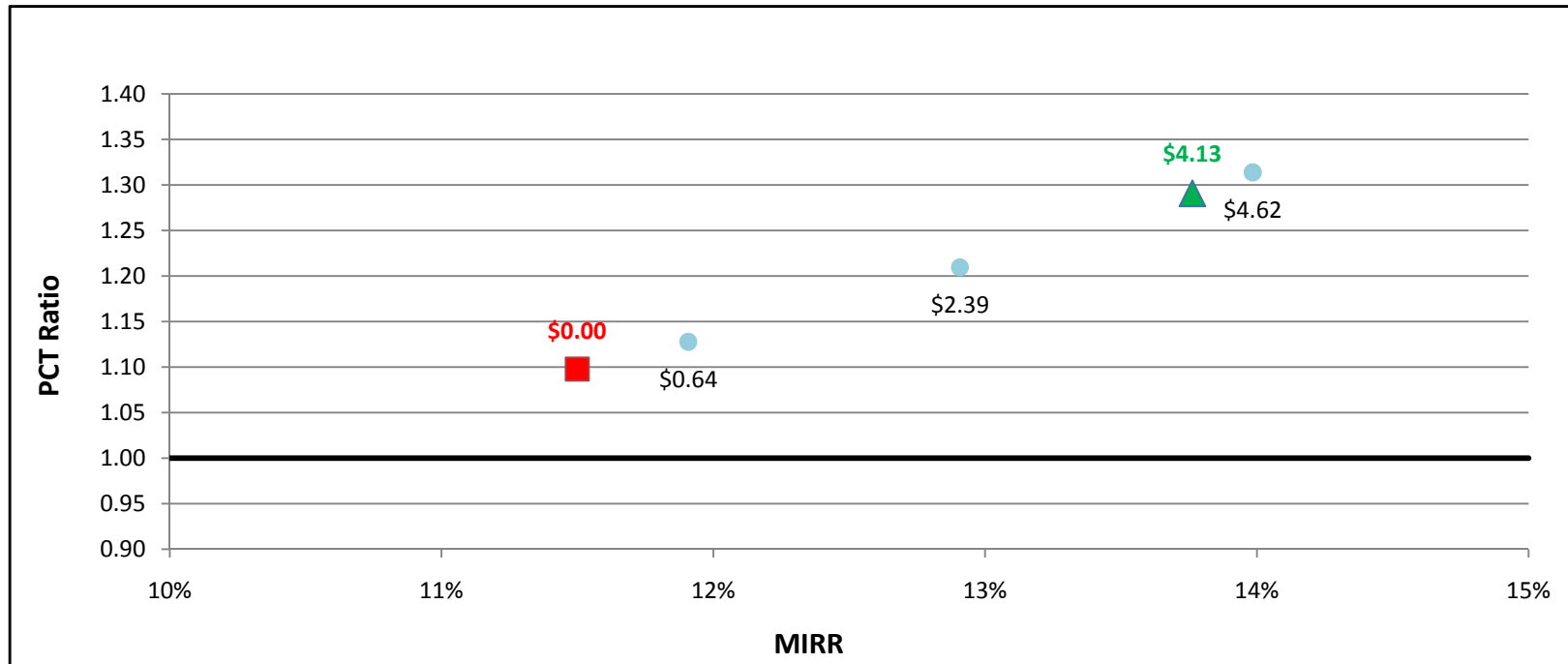

SGIP Cost Effectiveness Report
Participant Test Results (PCT)
MIRR Graphs

FC1200kW w/ On-Site BioGas - Commercial - SDG&E

	Rebate	MIRR	PCT-2010
▲ Actual Rebate - 2010	\$4.13	12.6%	1.17
■ No Rebate	\$0.00	9.8%	0.97
● Rebate to Reach MIRR of 10%	\$0.25	10.0%	0.98
● Rebate to Reach MIRR of 11%	\$1.48	11.0%	1.04
● Rebate to Reach MIRR of 12%	\$2.91	11.9%	1.11
● Rebate to Reach MIRR of 13%	\$4.80	13.0%	1.20
● Rebate to Reach MIRR of 14%	\$0.00	0.0%	0.00
● Rebate to Reach MIRR of 15%	\$0.00	0.0%	0.00

System Cost per Watt: \$6.08

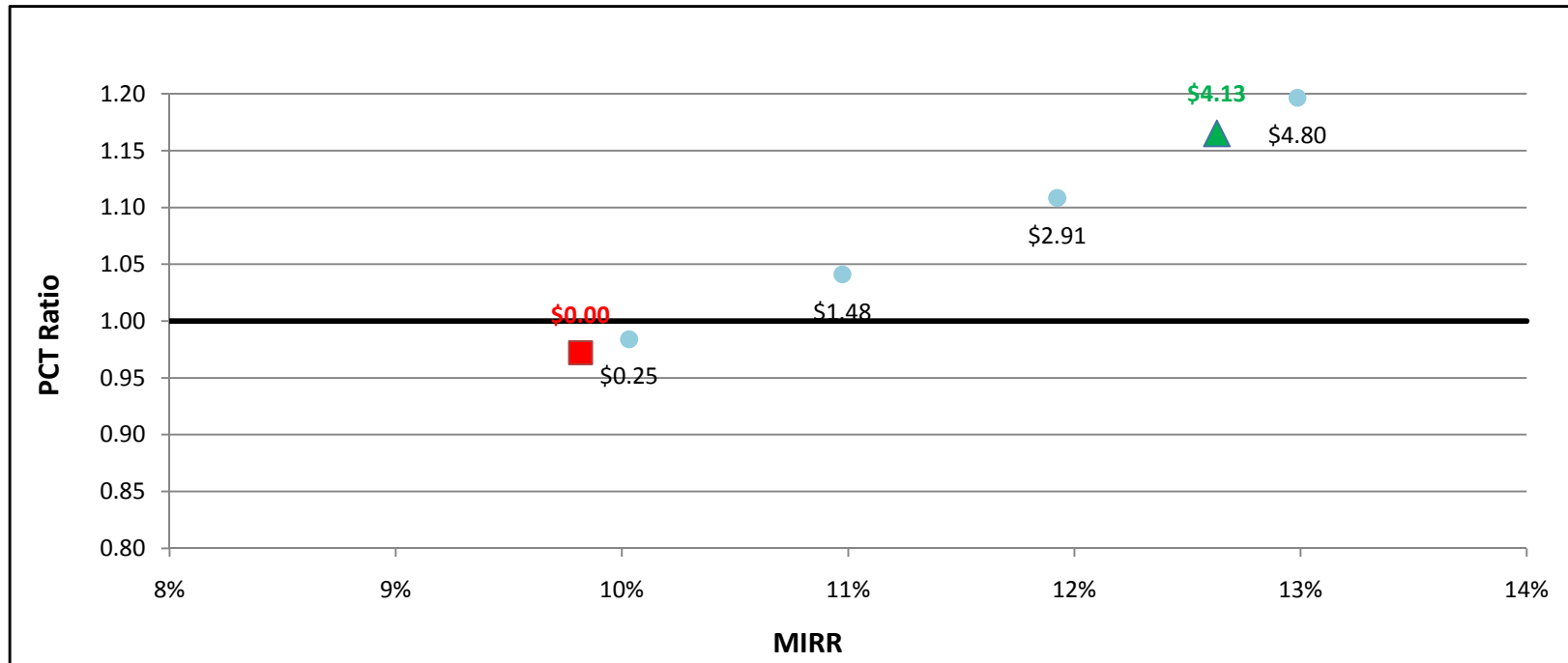

SGIP Cost Effectiveness Report
 Participant Test Results (PCT)
 MIRR Graphs

FC1200kWe w/ Directed BioGas - Government/Non-Profit - PG&E

	Rebate	MIRR	PCT-2010
▲ Actual Rebate - 2010	\$4.13	2.1%	0.98
■ No Rebate	\$0.00	-7.9%	0.79
● Rebate to Reach MIRR of 10%	\$6.39	10.0%	1.08
● Rebate to Reach MIRR of 11%	\$6.62	11.0%	1.09
● Rebate to Reach MIRR of 12%	\$6.84	12.0%	1.10
● Rebate to Reach MIRR of 13%	\$7.05	13.0%	1.11
● Rebate to Reach MIRR of 14%	\$7.23	14.0%	1.12
● Rebate to Reach MIRR of 15%	\$7.40	15.0%	1.13

System Cost per Watt: \$8.57

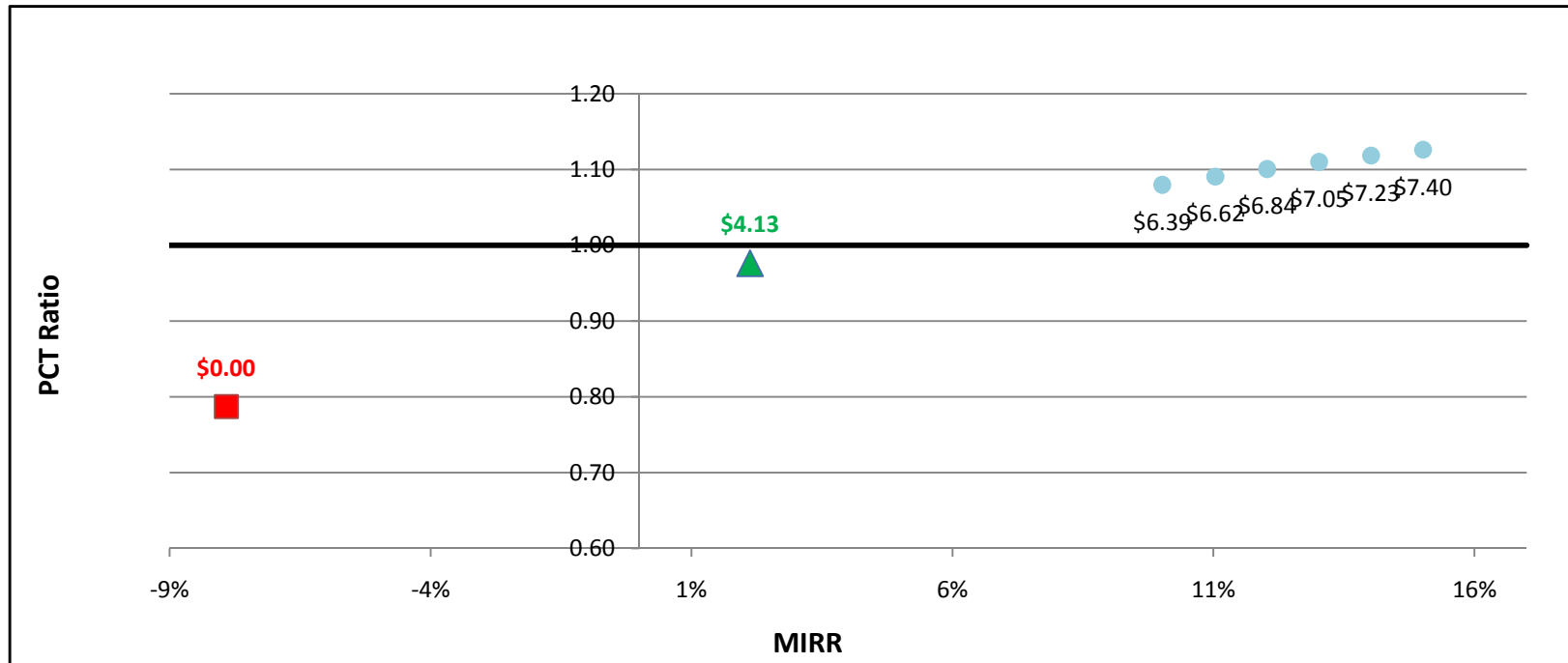

SGIP Cost Effectiveness Report
 Participant Test Results (PCT)
 MIRR Graphs

FC1200kWe w/ Directed BioGas - Government/Non-Profit - SCE

	Rebate	MIRR	PCT-2010
▲ Actual Rebate - 2010	\$4.13	-0.5%	0.95
■ No Rebate	\$0.00	-9.3%	0.76
● Rebate to Reach MIRR of 10%	\$6.79	10.0%	1.07
● Rebate to Reach MIRR of 11%	\$6.98	11.0%	1.08
● Rebate to Reach MIRR of 12%	\$7.14	12.0%	1.08
● Rebate to Reach MIRR of 13%	\$7.30	13.0%	1.09
● Rebate to Reach MIRR of 14%	\$7.45	14.0%	1.10
● Rebate to Reach MIRR of 15%	\$7.59	15.0%	1.10

System Cost per Watt: \$8.57

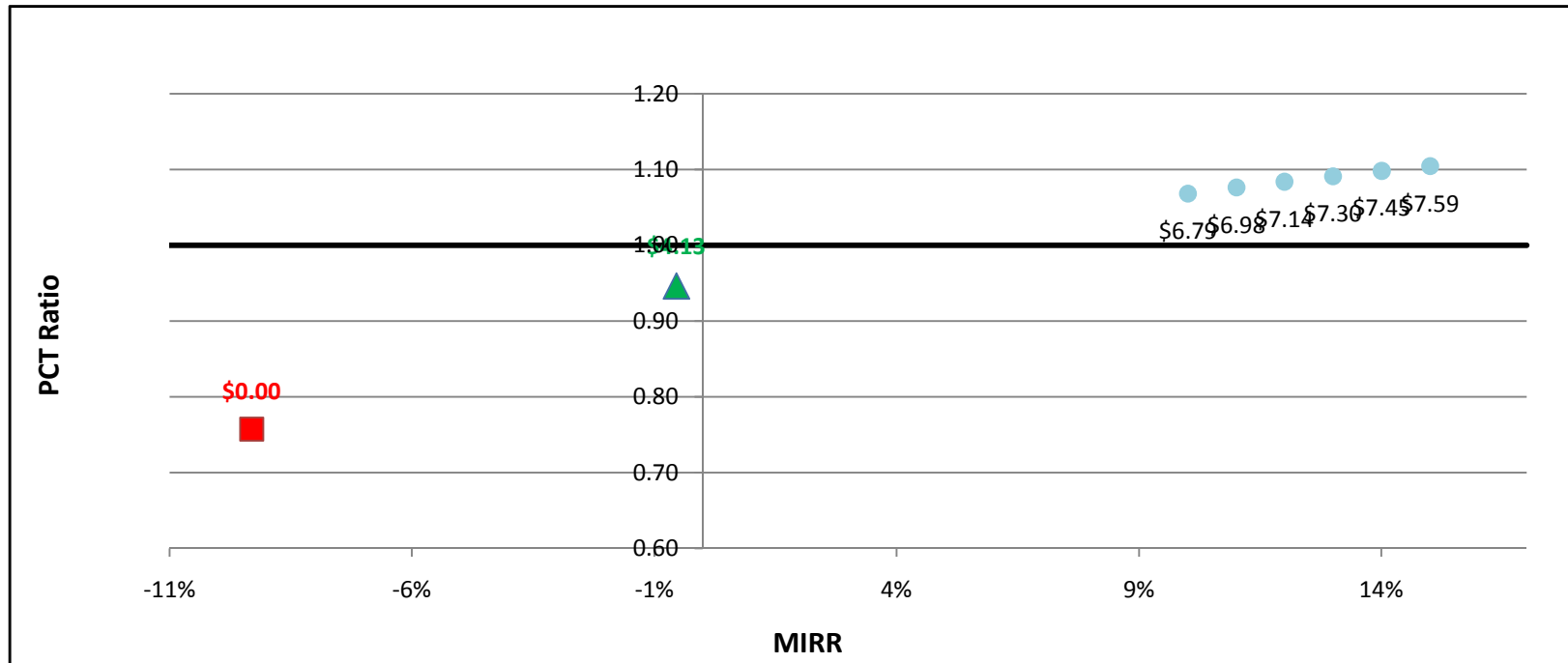

SGIP Cost Effectiveness Report
Participant Test Results (PCT)
MIRR Graphs

FC1200kWe w/ Directed BioGas - Government/Non-Profit - SDG&E

	Rebate	MIRR	PCT-2010
▲ Actual Rebate - 2010	\$4.13	-100.0%	0.76
■ No Rebate	\$0.00	-100.0%	0.58
● Rebate to Reach MIRR of 10%	\$0.00	0.0%	0.00
● Rebate to Reach MIRR of 11%	\$0.00	0.0%	0.00
● Rebate to Reach MIRR of 12%	\$0.00	0.0%	0.00
● Rebate to Reach MIRR of 13%	\$0.00	0.0%	0.00
● Rebate to Reach MIRR of 14%	\$0.00	0.0%	0.00
● Rebate to Reach MIRR of 15%	\$0.00	0.0%	0.00

System Cost per Watt: \$8.57

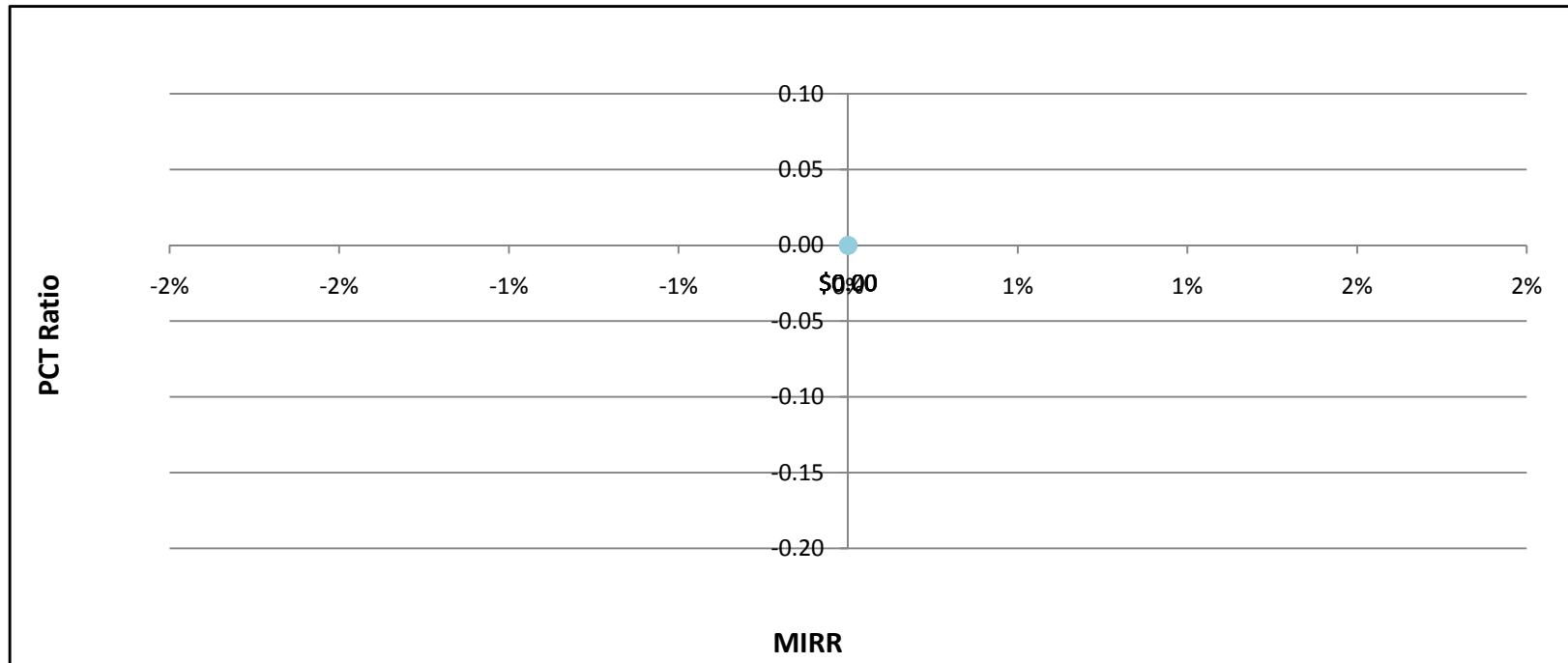

SGIP Cost Effectiveness Report
Participant Test Results (PCT)
MIRR Graphs

FC1200kWe w/ Natural Gas - Government/Non-Profit - PG&E

	Rebate	MIRR	PCT-2010
▲ Actual Rebate - 2010	\$2.29	0.1%	0.94
■ No Rebate	\$0.00	-5.2%	0.81
● Rebate to Reach MIRR of 10%	\$5.70	10.0%	1.13
● Rebate to Reach MIRR of 11%	\$6.04	11.1%	1.14
● Rebate to Reach MIRR of 12%	\$6.32	12.1%	1.16
● Rebate to Reach MIRR of 13%	\$6.58	13.1%	1.17
● Rebate to Reach MIRR of 14%	\$6.82	14.0%	1.19
● Rebate to Reach MIRR of 15%	\$7.04	15.0%	1.20

System Cost per Watt: \$8.57

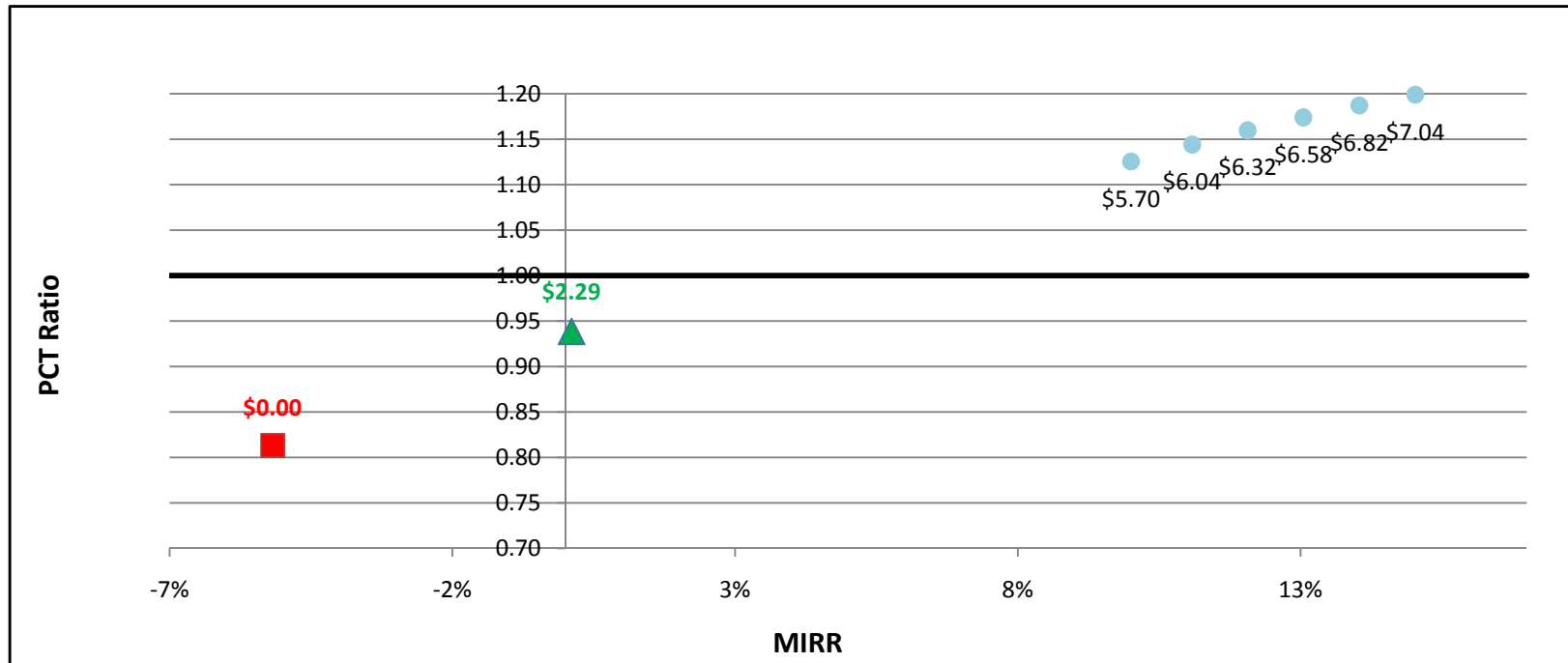

SGIP Cost Effectiveness Report
 Participant Test Results (PCT)
 MIRR Graphs

FC1200kWe w/ Natural Gas - Government/Non-Profit - SCE

	Rebate	MIRR	PCT-2010
▲ Actual Rebate - 2010	\$2.29	-2.4%	0.90
■ No Rebate	\$0.00	-6.6%	0.78
● Rebate to Reach MIRR of 10%	\$6.08	10.1%	1.11
● Rebate to Reach MIRR of 11%	\$6.35	11.1%	1.13
● Rebate to Reach MIRR of 12%	\$6.60	12.0%	1.14
● Rebate to Reach MIRR of 13%	\$6.83	13.0%	1.15
● Rebate to Reach MIRR of 14%	\$7.04	14.0%	1.16
● Rebate to Reach MIRR of 15%	\$7.23	15.0%	1.17

System Cost per Watt: \$8.57

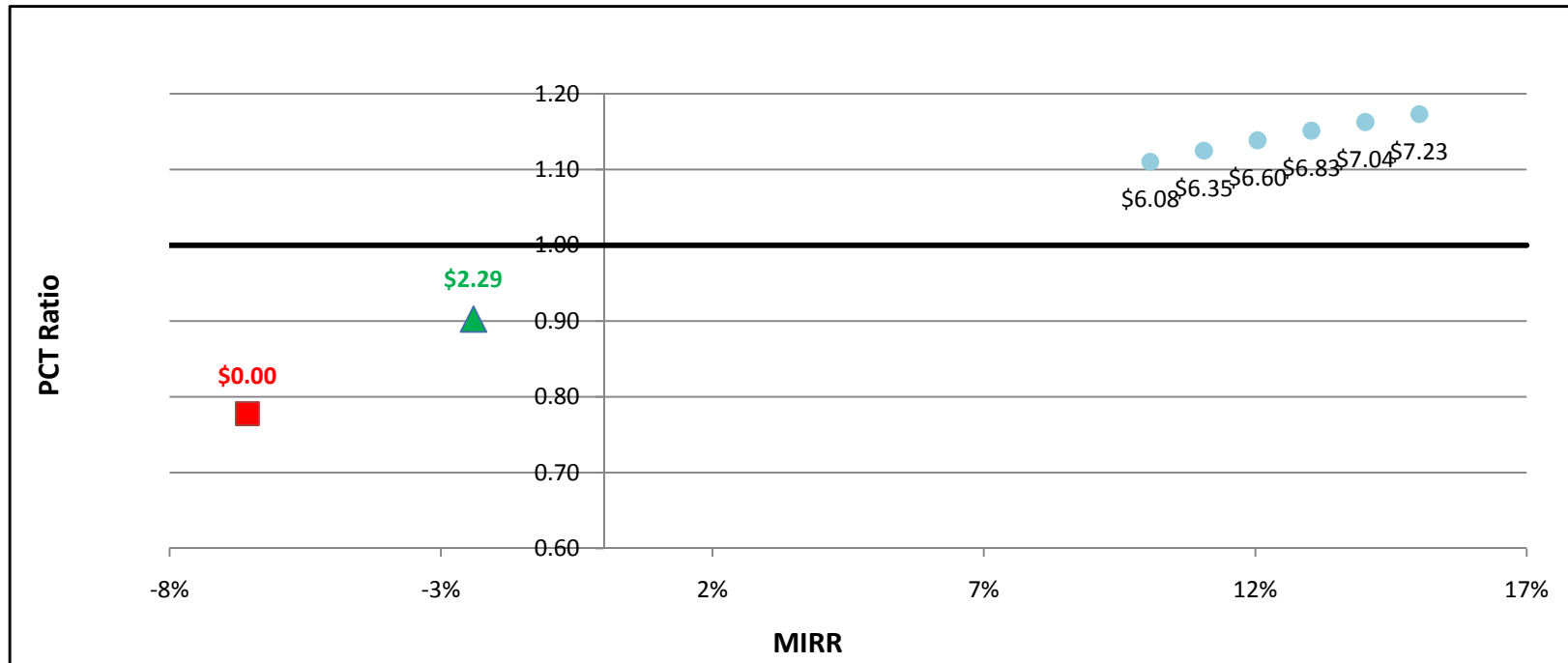

SGIP Cost Effectiveness Report
 Participant Test Results (PCT)
 MIRR Graphs

FC1200kWe w/ Natural Gas - Government/Non-Profit - SDG&E

	Rebate	MIRR	PCT-2010
▲ Actual Rebate - 2010	\$2.29	-17.8%	0.68
■ No Rebate	\$0.00	-19.2%	0.56
● Rebate to Reach MIRR of 10%	\$8.33	10.0%	1.01
● Rebate to Reach MIRR of 11%	\$8.36	11.0%	1.01
● Rebate to Reach MIRR of 12%	\$8.39	12.1%	1.01
● Rebate to Reach MIRR of 13%	\$8.41	13.0%	1.01
● Rebate to Reach MIRR of 14%	\$8.43	14.0%	1.02
● Rebate to Reach MIRR of 15%	\$8.45	15.0%	1.02

System Cost per Watt: \$8.57

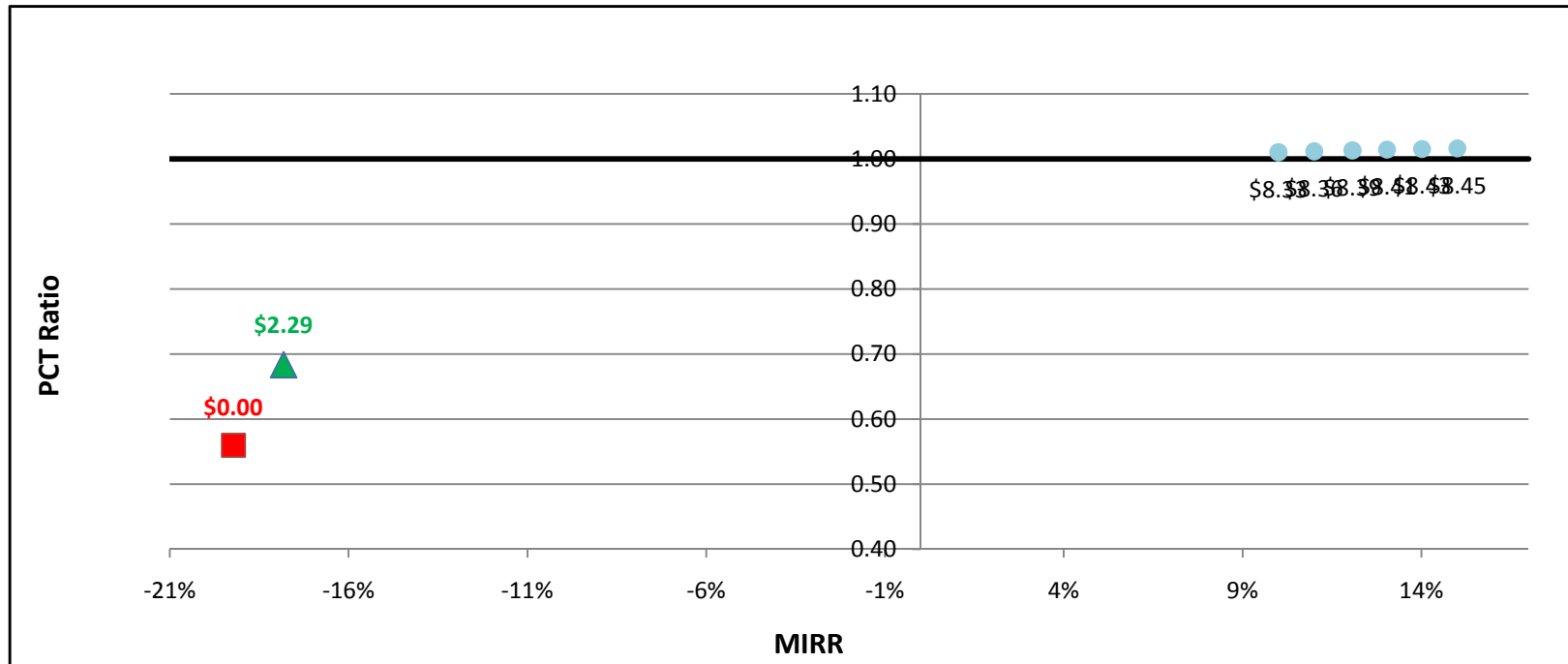

SGIP Cost Effectiveness Report
Participant Test Results (PCT)
MIRR Graphs

FC1200kWe w/ On-Site BioGas - Government/Non-Profit - PG&E

	Rebate	MIRR	PCT-2010
▲ Actual Rebate - 2010	\$4.13	7.3%	1.13
■ No Rebate	\$0.00	1.2%	0.91
● Rebate to Reach MIRR of 10%	\$5.81	10.0%	1.22
● Rebate to Reach MIRR of 11%	\$6.41	11.1%	1.25
● Rebate to Reach MIRR of 12%	\$6.91	12.0%	1.28
● Rebate to Reach MIRR of 13%	\$7.38	13.0%	1.30
● Rebate to Reach MIRR of 14%	\$7.83	14.0%	1.33
● Rebate to Reach MIRR of 15%	\$8.21	15.0%	1.35

System Cost per Watt: \$8.79

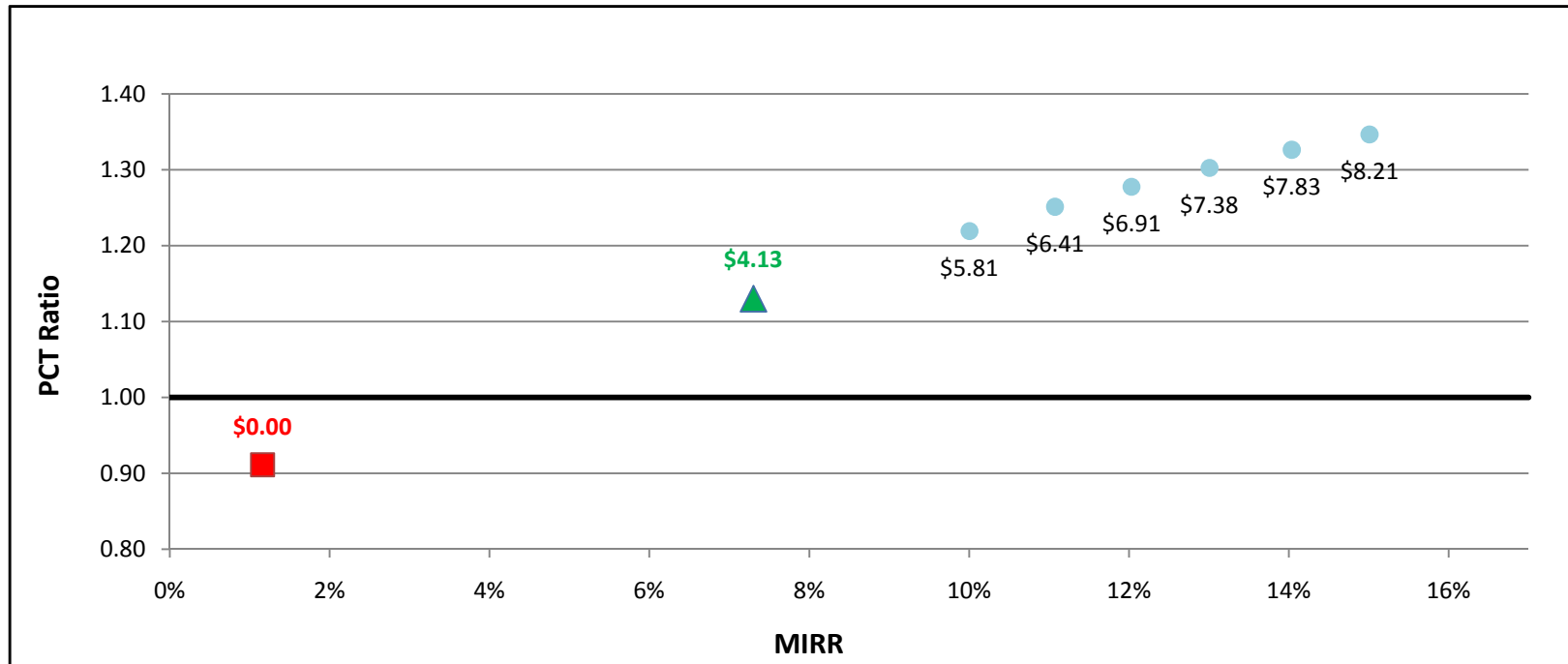

SGIP Cost Effectiveness Report
Participant Test Results (PCT)
MIRR Graphs

FC1200kWe w/ On-Site BioGas - Government/Non-Profit - SCE

	Rebate	MIRR	PCT-2010
▲ Actual Rebate - 2010	\$4.13	6.6%	1.10
■ No Rebate	\$0.00	0.0%	0.88
● Rebate to Reach MIRR of 10%	\$6.19	10.1%	1.21
● Rebate to Reach MIRR of 11%	\$6.69	11.0%	1.23
● Rebate to Reach MIRR of 12%	\$7.17	12.0%	1.26
● Rebate to Reach MIRR of 13%	\$7.64	13.1%	1.28
● Rebate to Reach MIRR of 14%	\$8.03	14.0%	1.30
● Rebate to Reach MIRR of 15%	\$8.41	15.1%	1.33

System Cost per Watt: \$8.79

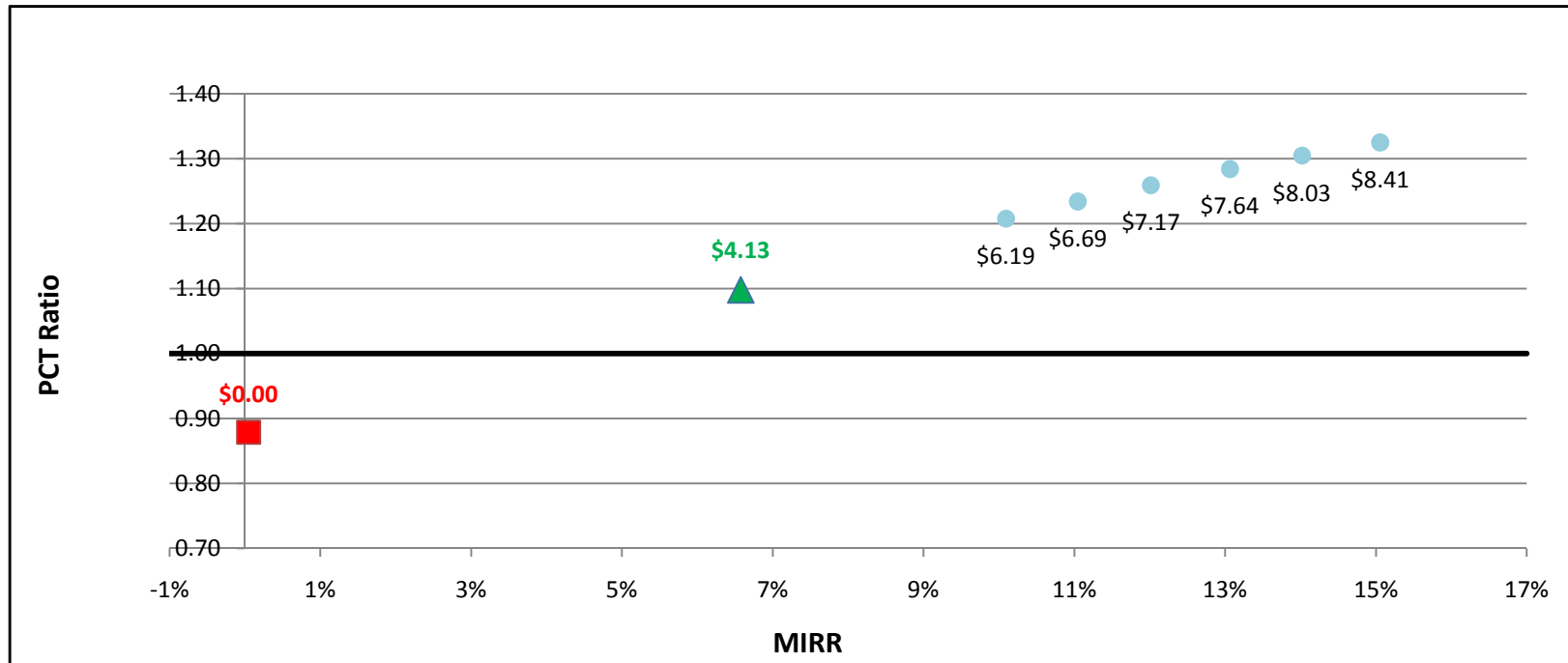

SGIP Cost Effectiveness Report
Participant Test Results (PCT)
MIRR Graphs

FC1200kWe w/ On-Site BioGas - Government/Non-Profit - SDG&E

	Rebate	MIRR	PCT-2010
▲ Actual Rebate - 2010	\$4.13	-1.6%	0.89
■ No Rebate	\$0.00	-7.8%	0.67
● Rebate to Reach MIRR of 10%	\$8.32	10.0%	1.12
● Rebate to Reach MIRR of 11%	\$8.59	11.0%	1.13
● Rebate to Reach MIRR of 12%	\$0.00	0.0%	0.00
● Rebate to Reach MIRR of 13%	\$0.00	0.0%	0.00
● Rebate to Reach MIRR of 14%	\$0.00	0.0%	0.00
● Rebate to Reach MIRR of 15%	\$0.00	0.0%	0.00

System Cost per Watt: \$8.79

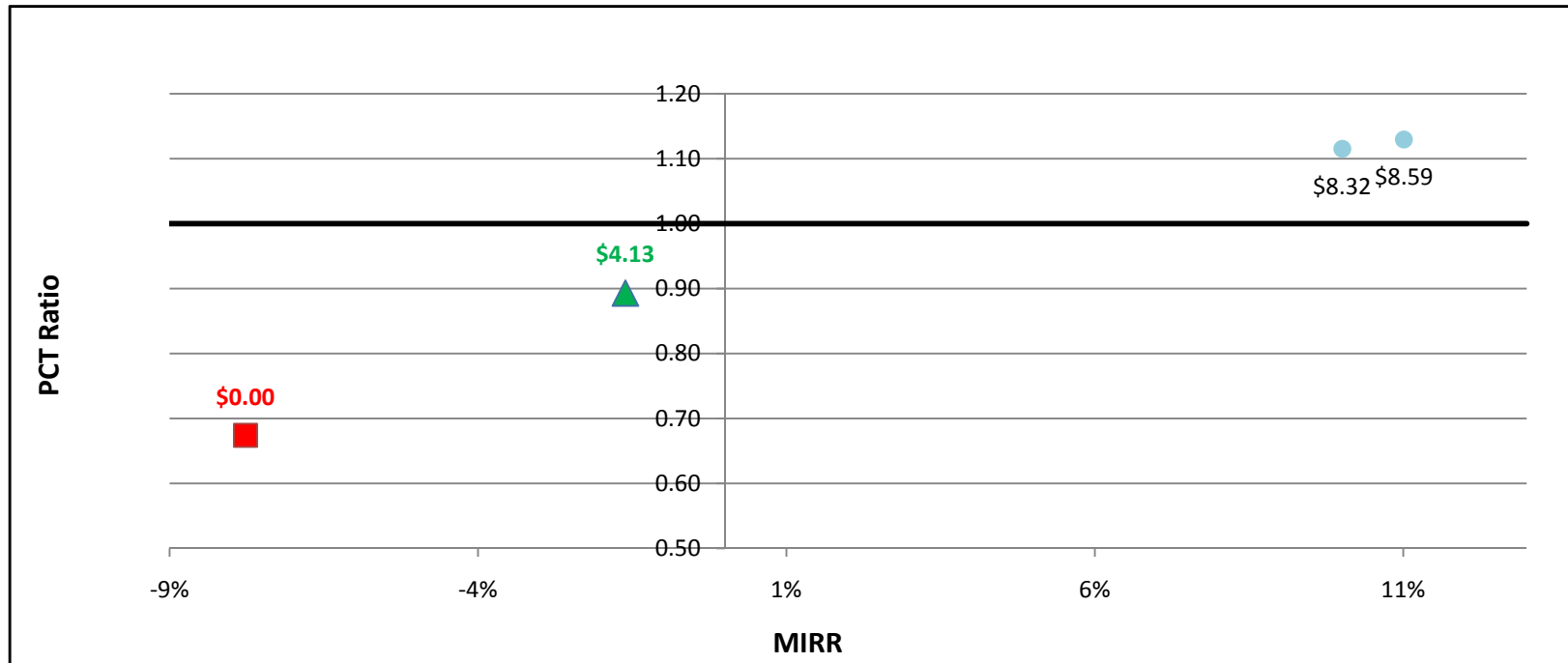

SGIP Cost Effectiveness Report
Participant Test Results (PCT)
MIRR Graphs

FC1200kWe w/ Directed BioGas - Commercial - PG&E

	Rebate	MIRR	PCT-2010
▲ Actual Rebate - 2010	\$4.13	11.5%	1.06
■ No Rebate	\$0.00	8.8%	0.92
● Rebate to Reach MIRR of 10%	\$1.60	10.0%	0.98
● Rebate to Reach MIRR of 11%	\$3.25	11.0%	1.03
● Rebate to Reach MIRR of 12%	\$4.98	12.0%	1.09
● Rebate to Reach MIRR of 13%	\$7.25	13.0%	1.17
● Rebate to Reach MIRR of 14%	\$0.00	0.0%	0.00
● Rebate to Reach MIRR of 15%	\$0.00	0.0%	0.00

System Cost per Watt: \$8.57

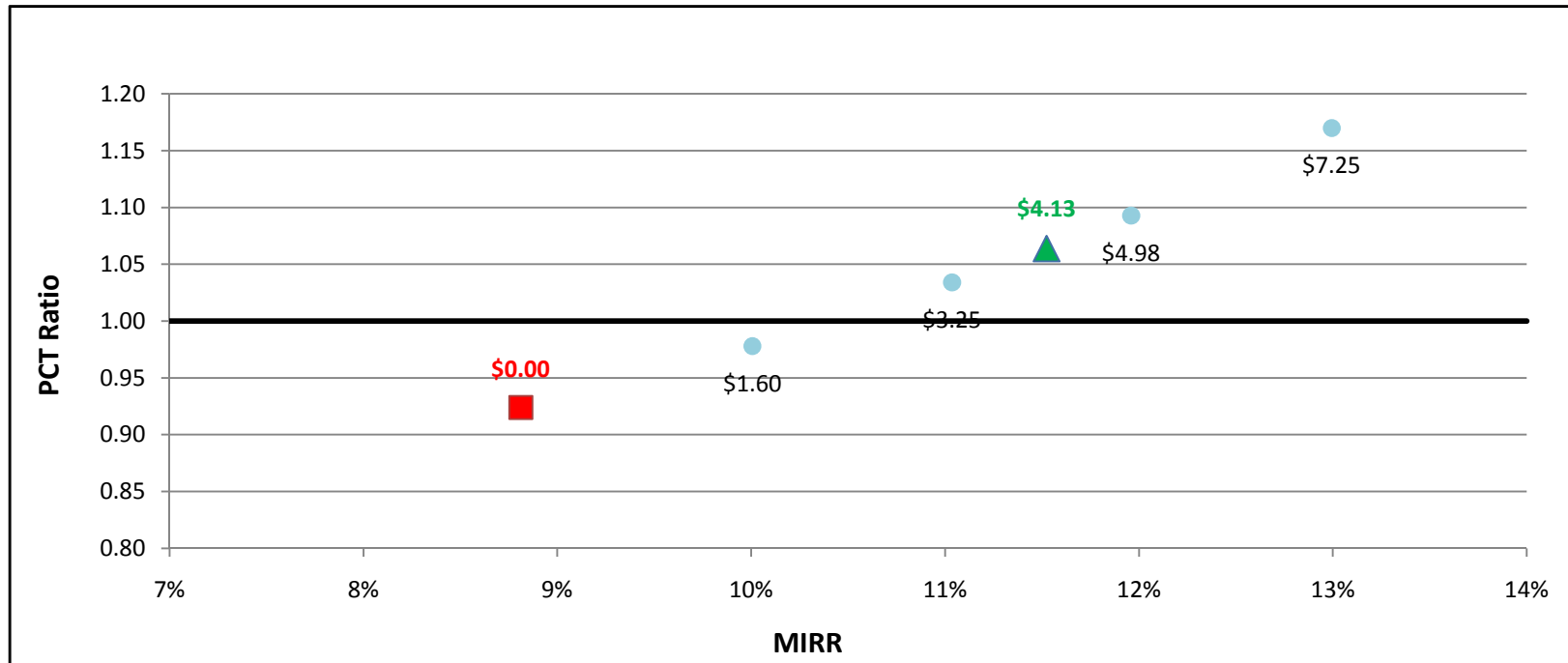

SGIP Cost Effectiveness Report
 Participant Test Results (PCT)
 MIRR Graphs

FC1200kWe w/ Directed BioGas - Commercial - SCE

	Rebate	MIRR	PCT-2010
▲ Actual Rebate - 2010	\$4.13	11.3%	1.05
■ No Rebate	\$0.00	8.5%	0.91
● Rebate to Reach MIRR of 10%	\$1.89	9.9%	0.97
● Rebate to Reach MIRR of 11%	\$3.66	11.0%	1.03
● Rebate to Reach MIRR of 12%	\$5.51	12.0%	1.10
● Rebate to Reach MIRR of 13%	\$7.77	13.0%	1.17
● Rebate to Reach MIRR of 14%	\$0.00	0.0%	0.00
● Rebate to Reach MIRR of 15%	\$0.00	0.0%	0.00

System Cost per Watt: \$8.57

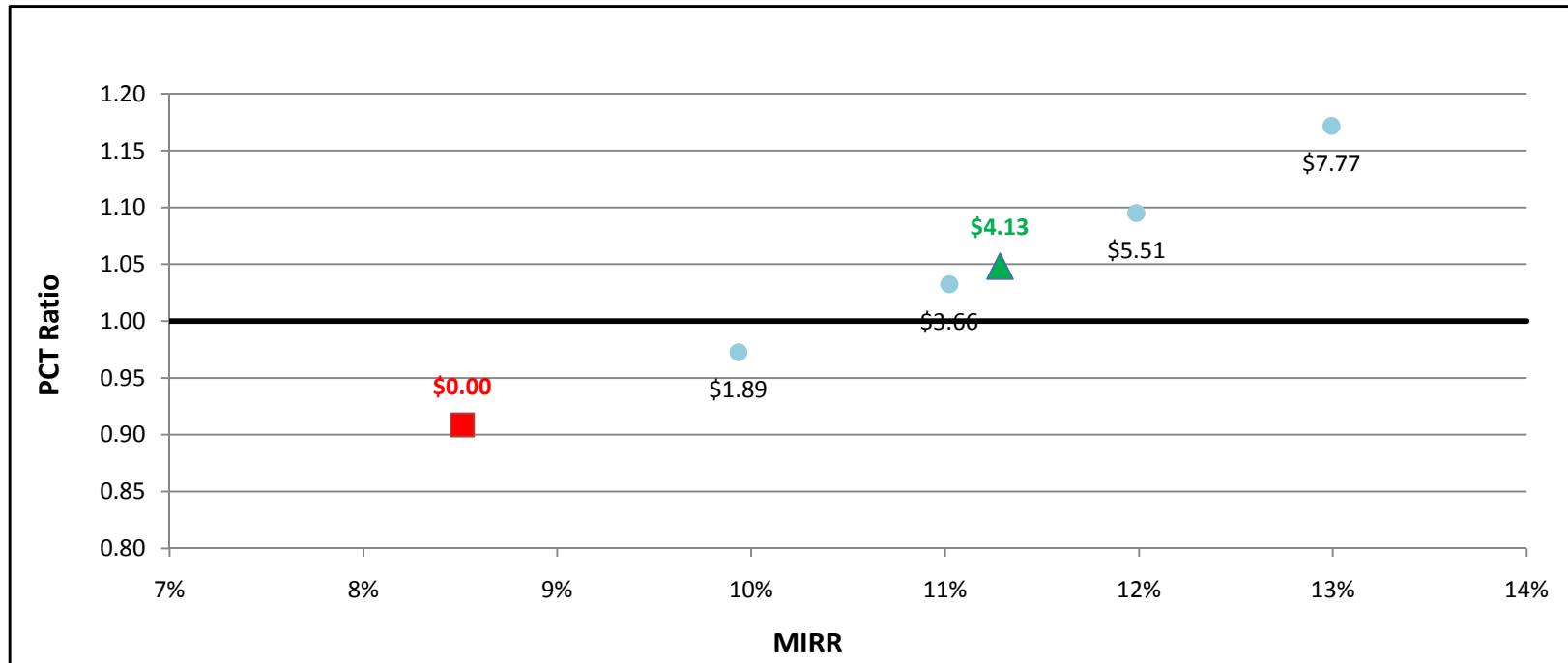

SGIP Cost Effectiveness Report
Participant Test Results (PCT)
MIRR Graphs

FC1200kWe w/ Directed BioGas - Commercial - SDG&E

	Rebate	MIRR	PCT-2010
▲ Actual Rebate - 2010	\$4.13	9.8%	0.95
■ No Rebate	\$0.00	6.6%	0.82
● Rebate to Reach MIRR of 10%	\$4.48	10.0%	0.97
● Rebate to Reach MIRR of 11%	\$6.24	10.9%	1.02
● Rebate to Reach MIRR of 12%	\$0.00	0.0%	0.00
● Rebate to Reach MIRR of 13%	\$0.00	0.0%	0.00
● Rebate to Reach MIRR of 14%	\$0.00	0.0%	0.00
● Rebate to Reach MIRR of 15%	\$0.00	0.0%	0.00

System Cost per Watt: \$8.57

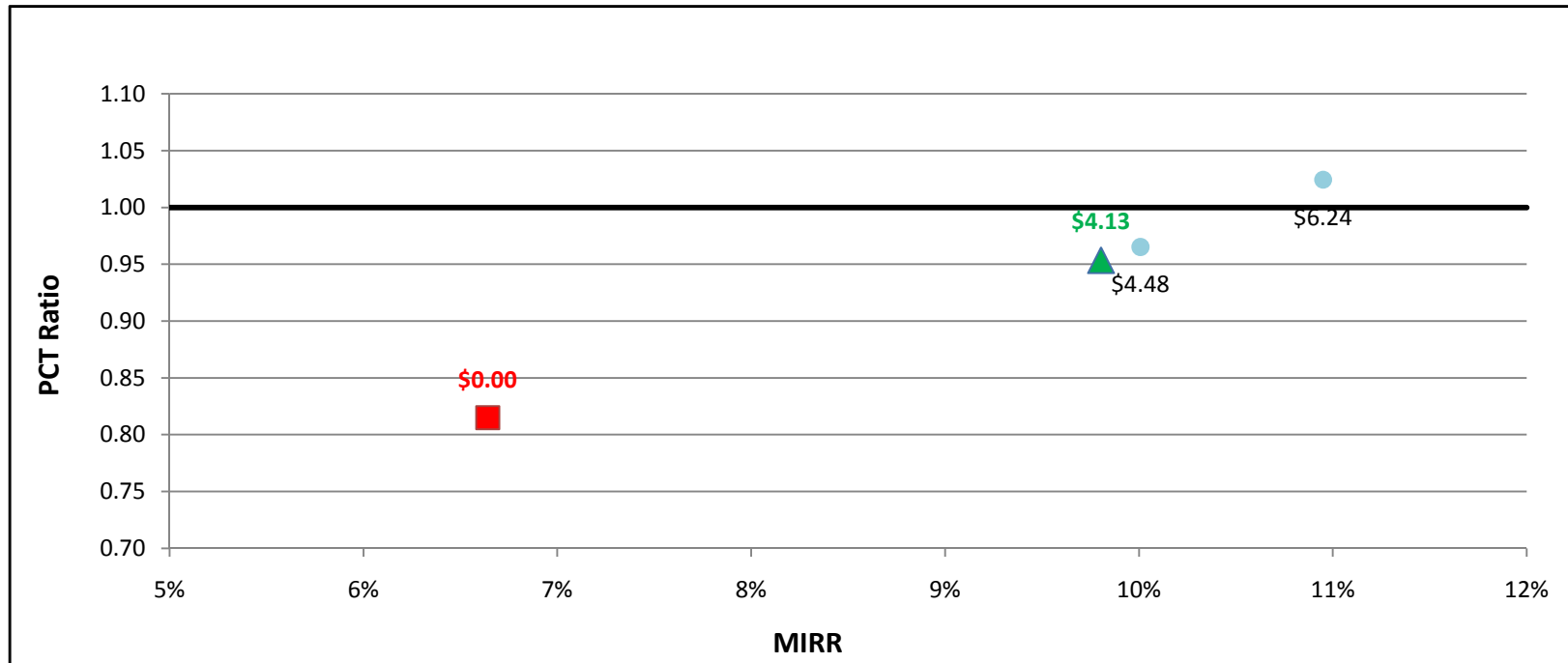

SGIP Cost Effectiveness Report
 Participant Test Results (PCT)
 MIRR Graphs

FC1200kWe w/ Natural Gas - Commercial - PG&E

	Rebate	MIRR	PCT-2010
▲ Actual Rebate - 2010	\$2.29	11.0%	1.04
■ No Rebate	\$0.00	9.4%	0.95
● Rebate to Reach MIRR of 10%	\$0.82	10.0%	0.98
● Rebate to Reach MIRR of 11%	\$2.48	11.1%	1.05
● Rebate to Reach MIRR of 12%	\$4.18	12.0%	1.11
● Rebate to Reach MIRR of 13%	\$6.23	13.0%	1.19
● Rebate to Reach MIRR of 14%	\$0.00	0.0%	0.00
● Rebate to Reach MIRR of 15%	\$0.00	0.0%	0.00

System Cost per Watt: \$8.57

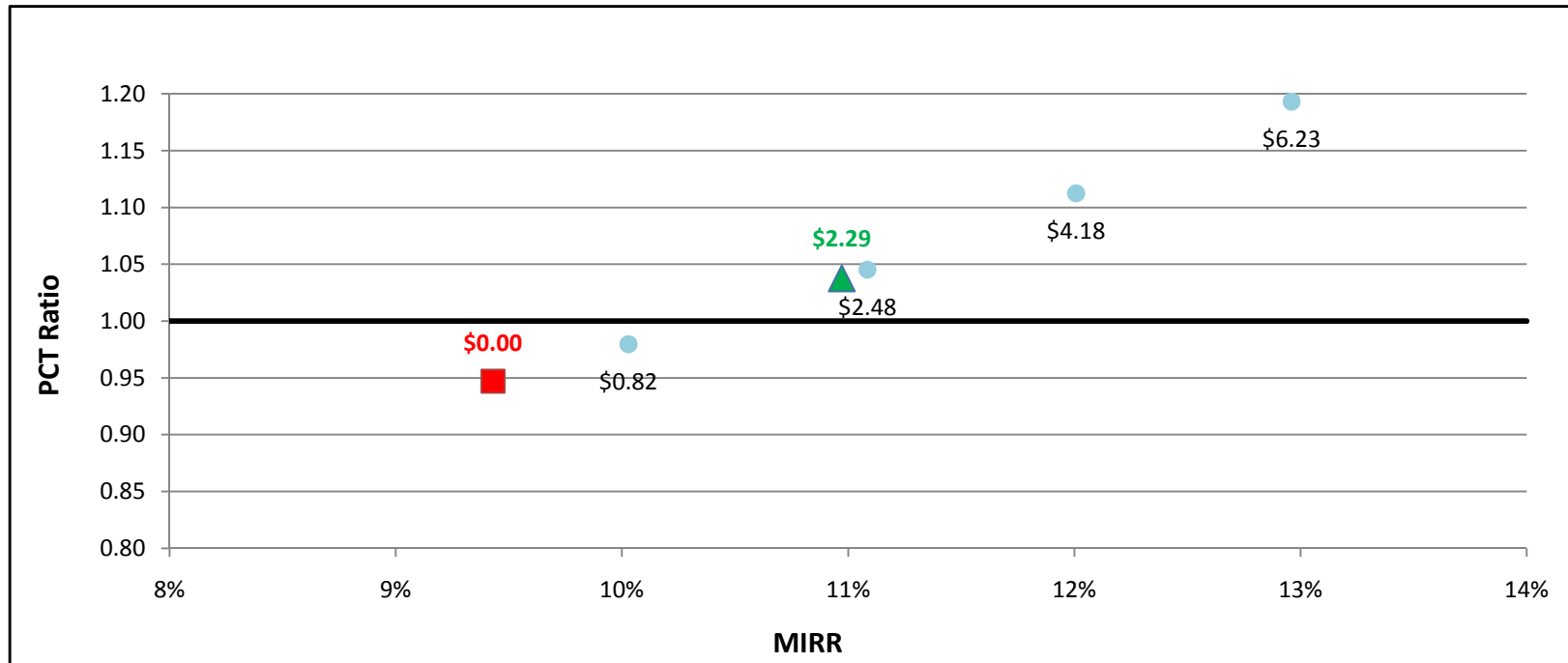

SGIP Cost Effectiveness Report
Participant Test Results (PCT)
MIRR Graphs

FC1200kWe w/ Natural Gas - Commercial - SCE

	Rebate	MIRR	PCT-2010
▲ Actual Rebate - 2010	\$2.29	10.7%	1.02
■ No Rebate	\$0.00	9.1%	0.93
● Rebate to Reach MIRR of 10%	\$1.20	10.0%	0.98
● Rebate to Reach MIRR of 11%	\$2.81	11.0%	1.04
● Rebate to Reach MIRR of 12%	\$4.50	11.9%	1.11
● Rebate to Reach MIRR of 13%	\$6.80	13.0%	1.20
● Rebate to Reach MIRR of 14%	\$0.00	0.0%	0.00
● Rebate to Reach MIRR of 15%	\$0.00	0.0%	0.00

System Cost per Watt: \$8.57

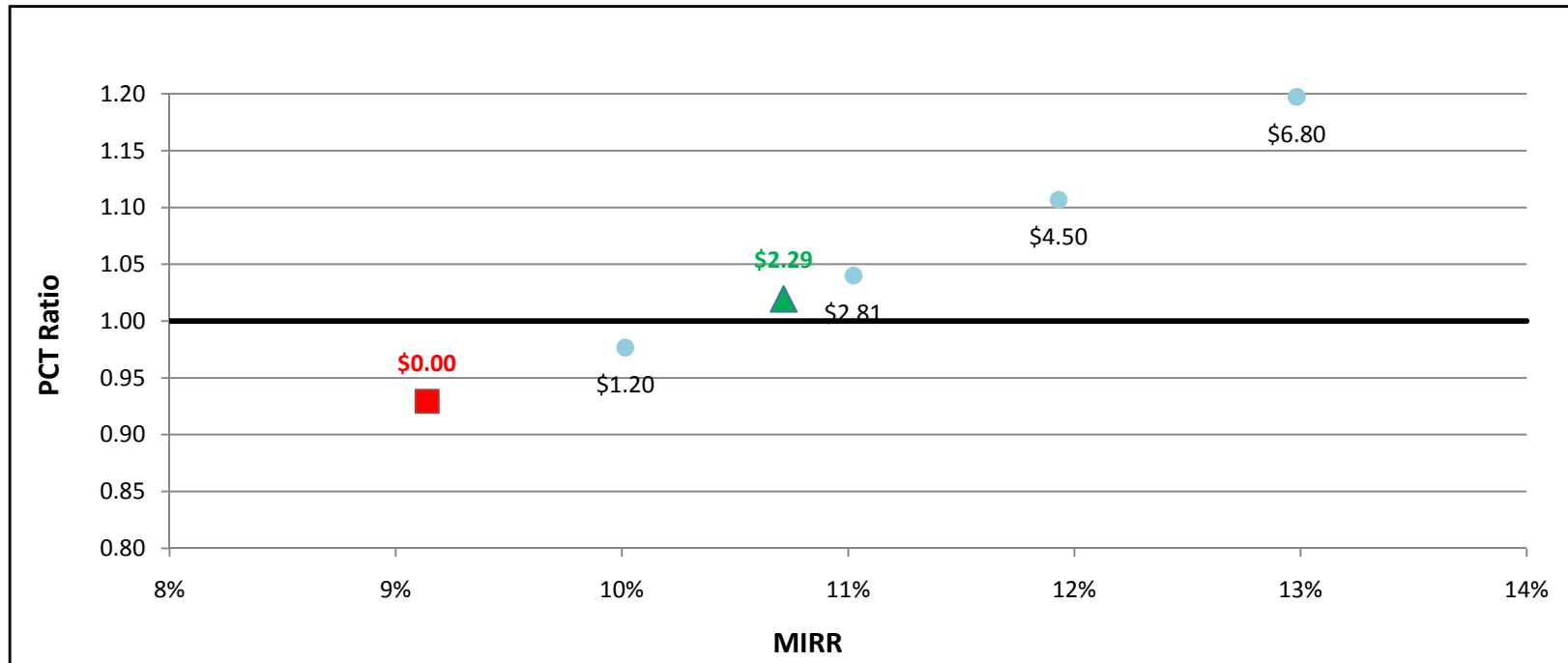

SGIP Cost Effectiveness Report
Participant Test Results (PCT)
MIRR Graphs

FC1200kWe w/ Natural Gas - Commercial - SDG&E

	Rebate	MIRR	PCT-2010
▲ Actual Rebate - 2010	\$2.29	9.1%	0.91
■ No Rebate	\$0.00	7.3%	0.82
● Rebate to Reach MIRR of 10%	\$3.68	10.0%	0.96
● Rebate to Reach MIRR of 11%	\$5.44	11.0%	1.03
● Rebate to Reach MIRR of 12%	\$7.62	12.0%	1.12
● Rebate to Reach MIRR of 13%	\$0.00	0.0%	0.00
● Rebate to Reach MIRR of 14%	\$0.00	0.0%	0.00
● Rebate to Reach MIRR of 15%	\$0.00	0.0%	0.00

System Cost per Watt: \$8.57

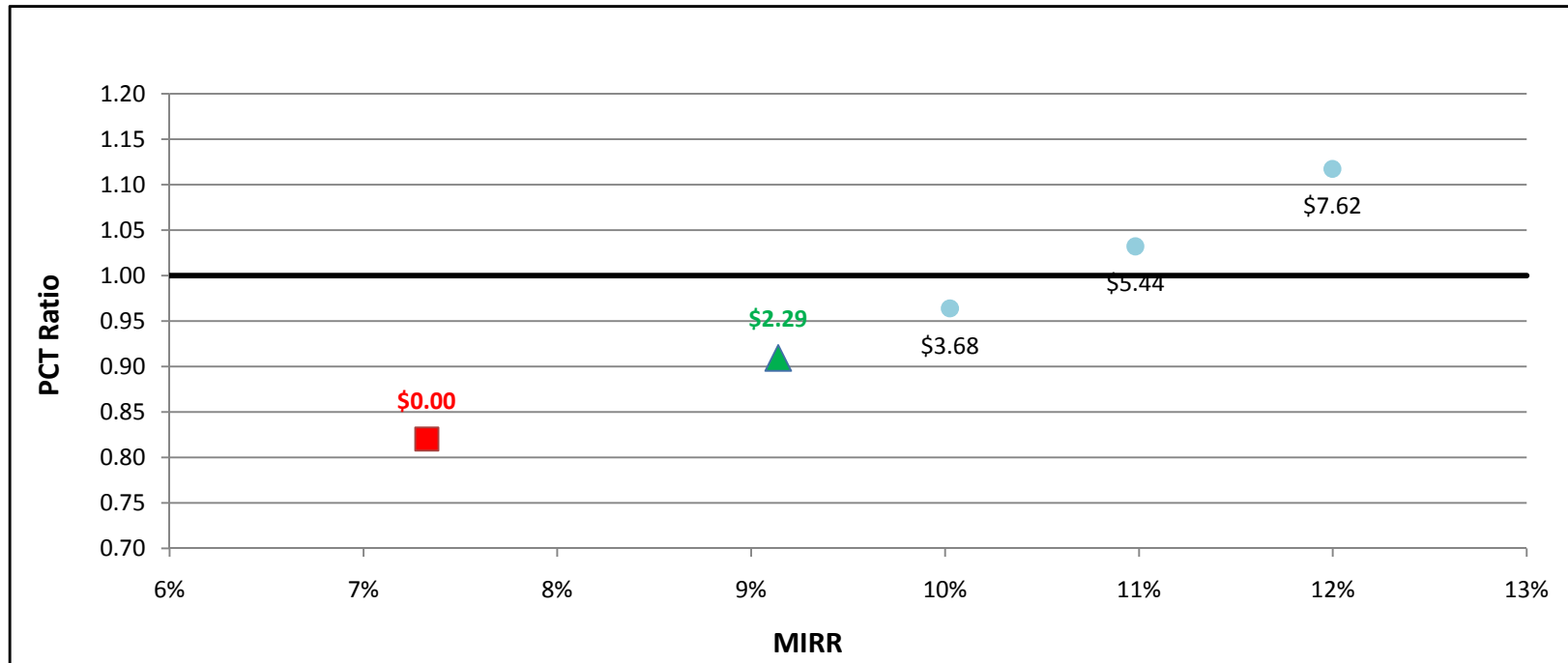

SGIP Cost Effectiveness Report
Participant Test Results (PCT)
MIRR Graphs

FC1200kWe w/ On-Site BioGas - Commercial - PG&E

	Rebate	MIRR	PCT-2010
▲ Actual Rebate - 2010	\$4.13	12.2%	1.15
■ No Rebate	\$0.00	10.3%	1.00
● Rebate to Reach MIRR of 10%	\$0.00	0.0%	0.00
● Rebate to Reach MIRR of 11%	\$1.20	10.9%	1.05
● Rebate to Reach MIRR of 12%	\$3.61	12.0%	1.13
● Rebate to Reach MIRR of 13%	\$6.05	13.0%	1.22
● Rebate to Reach MIRR of 14%	\$0.00	0.0%	0.00
● Rebate to Reach MIRR of 15%	\$0.00	0.0%	0.00

System Cost per Watt: \$8.79

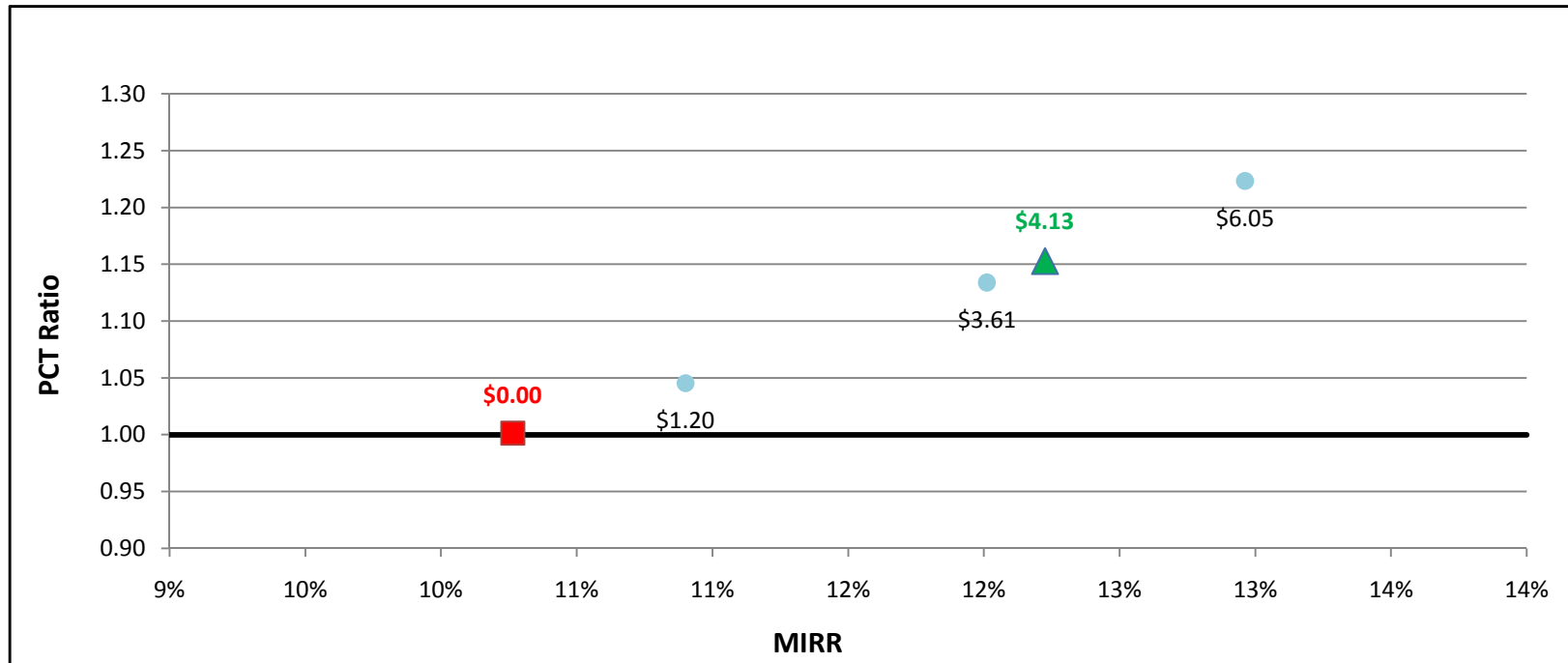

SGIP Cost Effectiveness Report
 Participant Test Results (PCT)
 MIRR Graphs

FC1200kWe w/ On-Site BioGas - Commercial - SCE

	Rebate	MIRR	PCT-2010
▲ Actual Rebate - 2010	\$4.13	12.1%	1.14
■ No Rebate	\$0.00	10.1%	0.99
● Rebate to Reach MIRR of 10%	\$0.00	0.0%	0.00
● Rebate to Reach MIRR of 11%	\$1.61	10.9%	1.05
● Rebate to Reach MIRR of 12%	\$3.95	12.0%	1.13
● Rebate to Reach MIRR of 13%	\$6.42	13.0%	1.22
● Rebate to Reach MIRR of 14%	\$0.00	0.0%	0.00
● Rebate to Reach MIRR of 15%	\$0.00	0.0%	0.00

System Cost per Watt: \$8.79

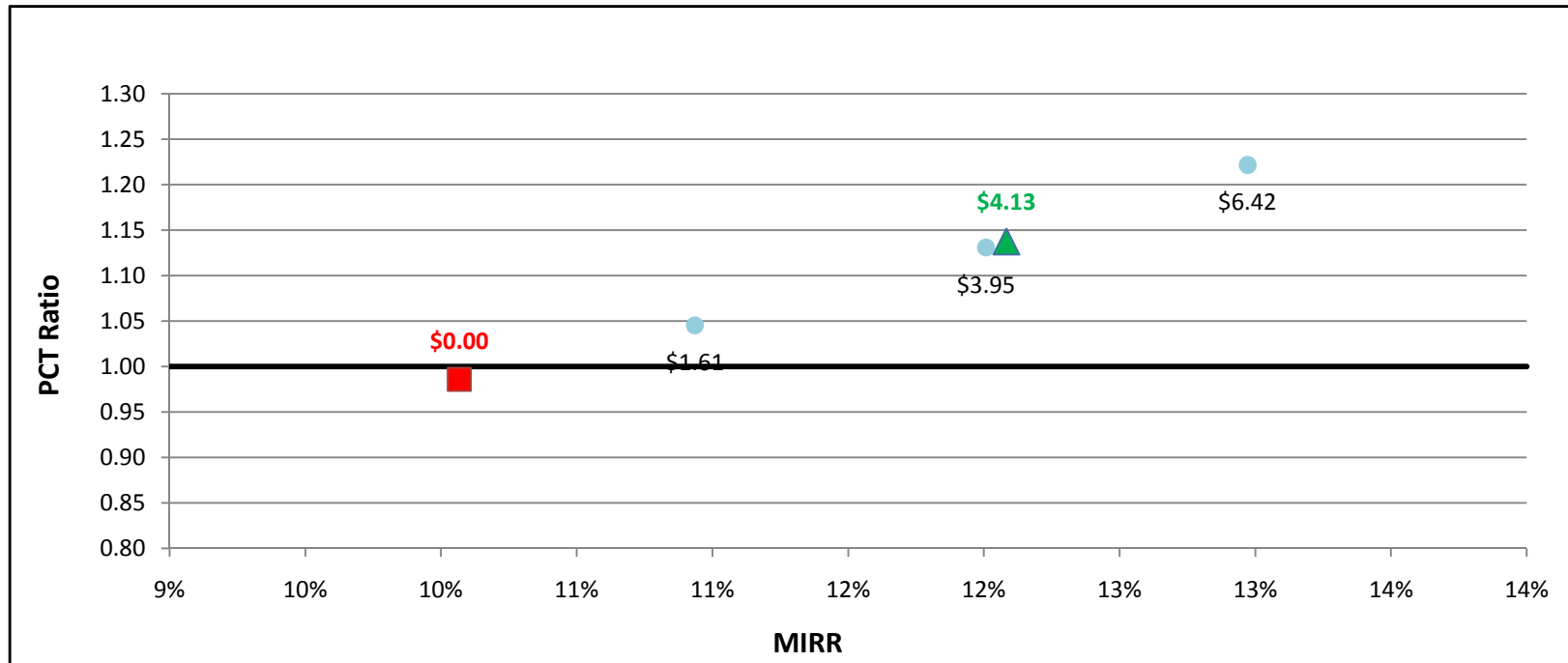

SGIP Cost Effectiveness Report
 Participant Test Results (PCT)
 MIRR Graphs

FC1200kWe w/ On-Site BioGas - Commercial - SDG&E

	Rebate	MIRR	PCT-2010
▲ Actual Rebate - 2010	\$4.13	10.9%	1.04
■ No Rebate	\$0.00	8.7%	0.89
● Rebate to Reach MIRR of 10%	\$2.16	10.0%	0.97
● Rebate to Reach MIRR of 11%	\$4.05	10.9%	1.04
● Rebate to Reach MIRR of 12%	\$6.62	12.0%	1.13
● Rebate to Reach MIRR of 13%	\$0.00	0.0%	0.00
● Rebate to Reach MIRR of 14%	\$0.00	0.0%	0.00
● Rebate to Reach MIRR of 15%	\$0.00	0.0%	0.00

System Cost per Watt: \$8.79

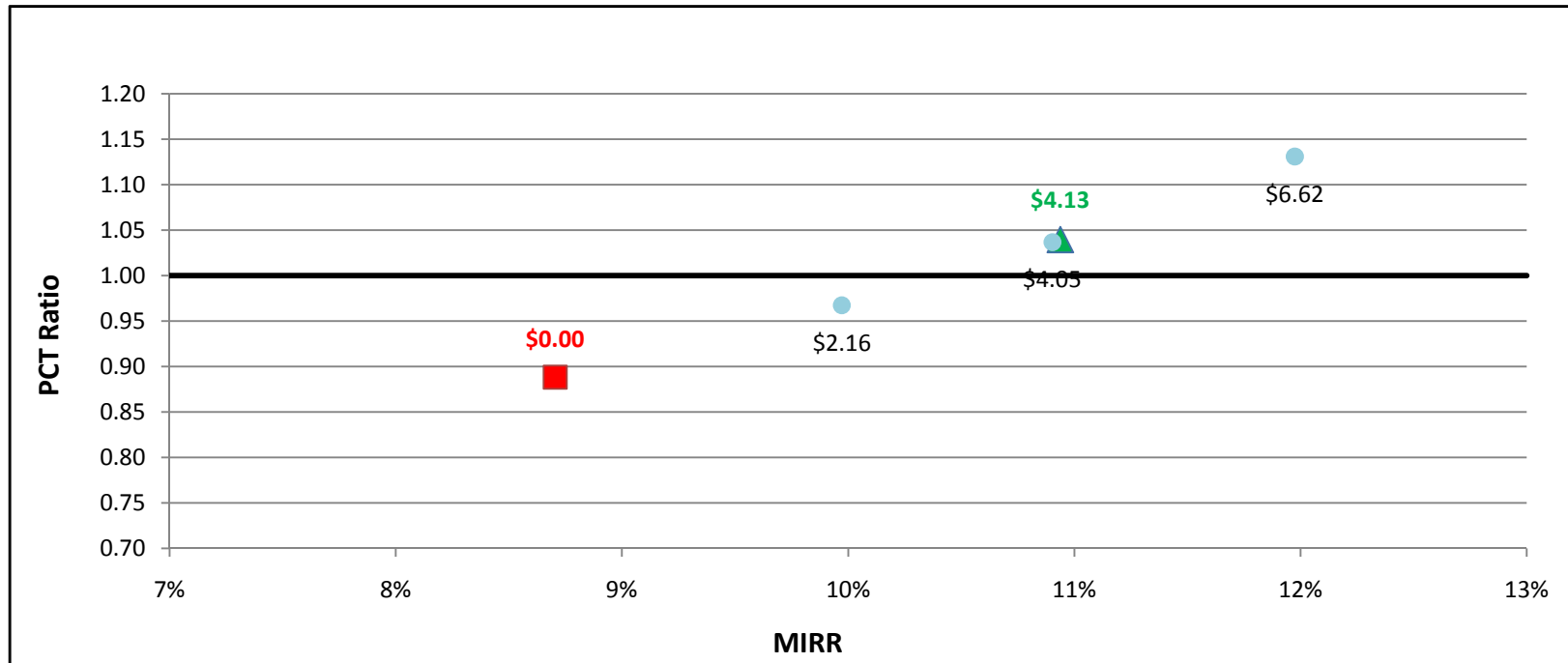

SGIP Cost Effectiveness Report
 Participant Test Results (PCT)
 MIRR Graphs

GTg2to5MW w/ Directed BioGas - Government/Non-Profit - PG&E

	Rebate	MIRR	PCT-2010
▲ Actual Rebate - 2010	\$0.00	5.9%	1.02
■ No Rebate	\$0.00	5.9%	1.02
● Rebate to Reach MIRR of 10%	\$0.79	10.0%	1.07
● Rebate to Reach MIRR of 11%	\$0.95	11.0%	1.08
● Rebate to Reach MIRR of 12%	\$1.10	12.0%	1.08
● Rebate to Reach MIRR of 13%	\$1.24	13.0%	1.09
● Rebate to Reach MIRR of 14%	\$1.38	14.0%	1.10
● Rebate to Reach MIRR of 15%	\$1.50	15.0%	1.11

System Cost per Watt: \$2.34

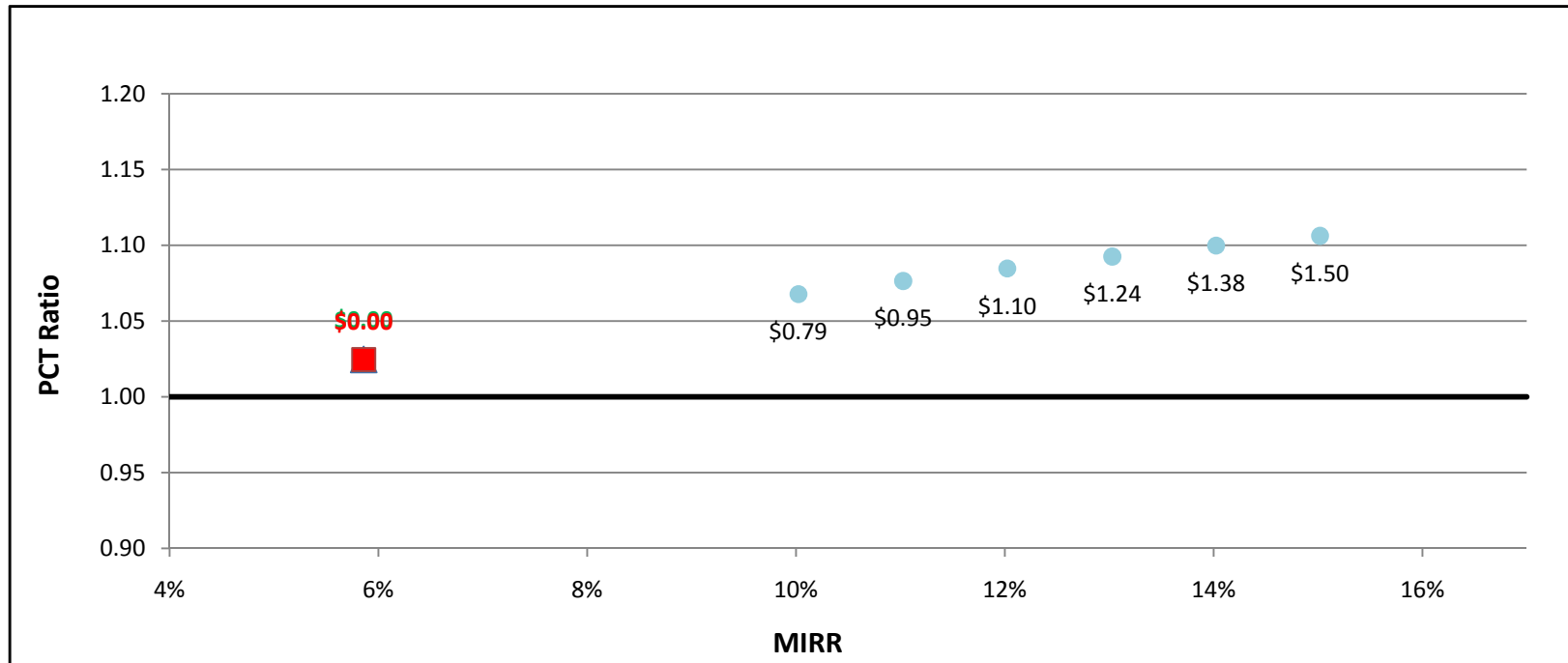

SGIP Cost Effectiveness Report
 Participant Test Results (PCT)
 MIRR Graphs

GTg2to5MW w/ Directed BioGas - Government/Non-Profit - SCE

	Rebate	MIRR	PCT-2010
▲ Actual Rebate - 2010	\$0.00	3.6%	1.00
■ No Rebate	\$0.00	3.6%	1.00
● Rebate to Reach MIRR of 10%	\$1.10	10.0%	1.06
● Rebate to Reach MIRR of 11%	\$1.23	11.0%	1.06
● Rebate to Reach MIRR of 12%	\$1.35	12.0%	1.07
● Rebate to Reach MIRR of 13%	\$1.46	13.0%	1.08
● Rebate to Reach MIRR of 14%	\$1.56	14.0%	1.08
● Rebate to Reach MIRR of 15%	\$1.65	15.0%	1.09

System Cost per Watt: \$2.34

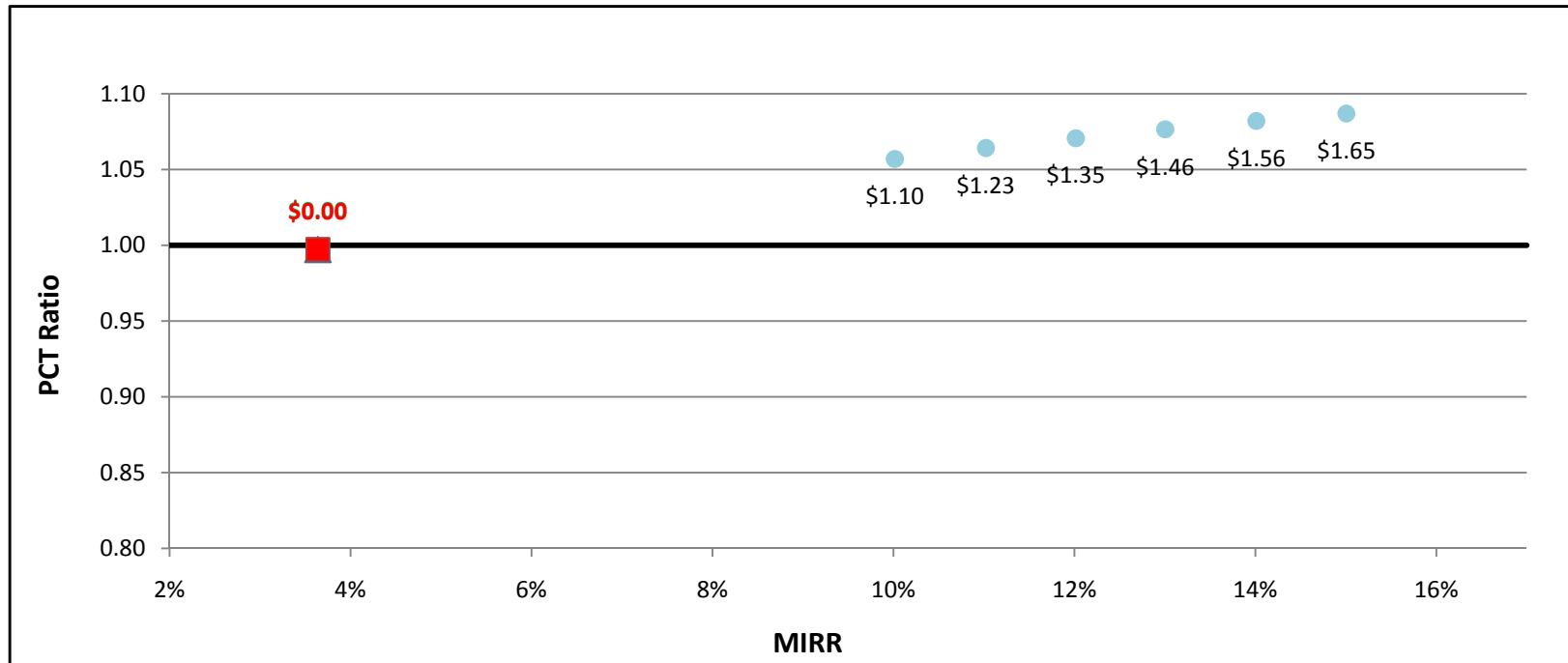

SGIP Cost Effectiveness Report
Participant Test Results (PCT)
MIRR Graphs

GTg2to5MW w/ Directed BioGas - Government/Non-Profit - SDG&E

	Rebate	MIRR	PCT-2010
▲ Actual Rebate - 2010	\$0.00	-100.0%	0.78
■ No Rebate	\$0.00	-100.0%	0.78
● Rebate to Reach MIRR of 10%	\$0.00	0.0%	0.00
● Rebate to Reach MIRR of 11%	\$0.00	0.0%	0.00
● Rebate to Reach MIRR of 12%	\$0.00	0.0%	0.00
● Rebate to Reach MIRR of 13%	\$0.00	0.0%	0.00
● Rebate to Reach MIRR of 14%	\$0.00	0.0%	0.00
● Rebate to Reach MIRR of 15%	\$0.00	0.0%	0.00

System Cost per Watt: \$2.34

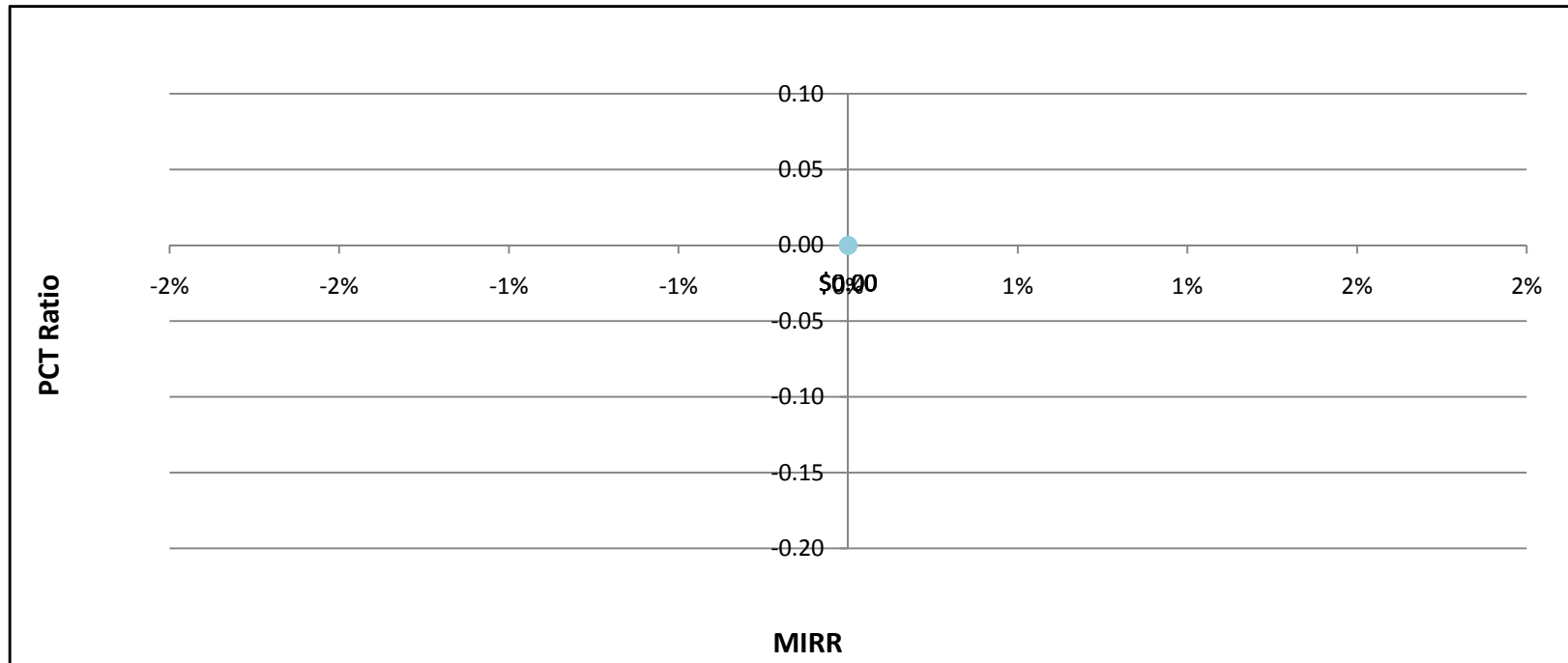

SGIP Cost Effectiveness Report
Participant Test Results (PCT)
MIRR Graphs

GTg2to5MW w/ Natural Gas - Government/Non-Profit - PG&E

	Rebate	MIRR	PCT-2010
▲ Actual Rebate - 2010	\$0.00	13.0%	1.28
■ No Rebate	\$0.00	13.0%	1.28
● Rebate to Reach MIRR of 10%	\$0.00	0.0%	0.00
● Rebate to Reach MIRR of 11%	\$0.00	0.0%	0.00
● Rebate to Reach MIRR of 12%	\$0.00	0.0%	0.00
● Rebate to Reach MIRR of 13%	\$0.01	13.0%	1.28
● Rebate to Reach MIRR of 14%	\$0.29	14.0%	1.31
● Rebate to Reach MIRR of 15%	\$0.54	15.0%	1.33

System Cost per Watt: \$2.34

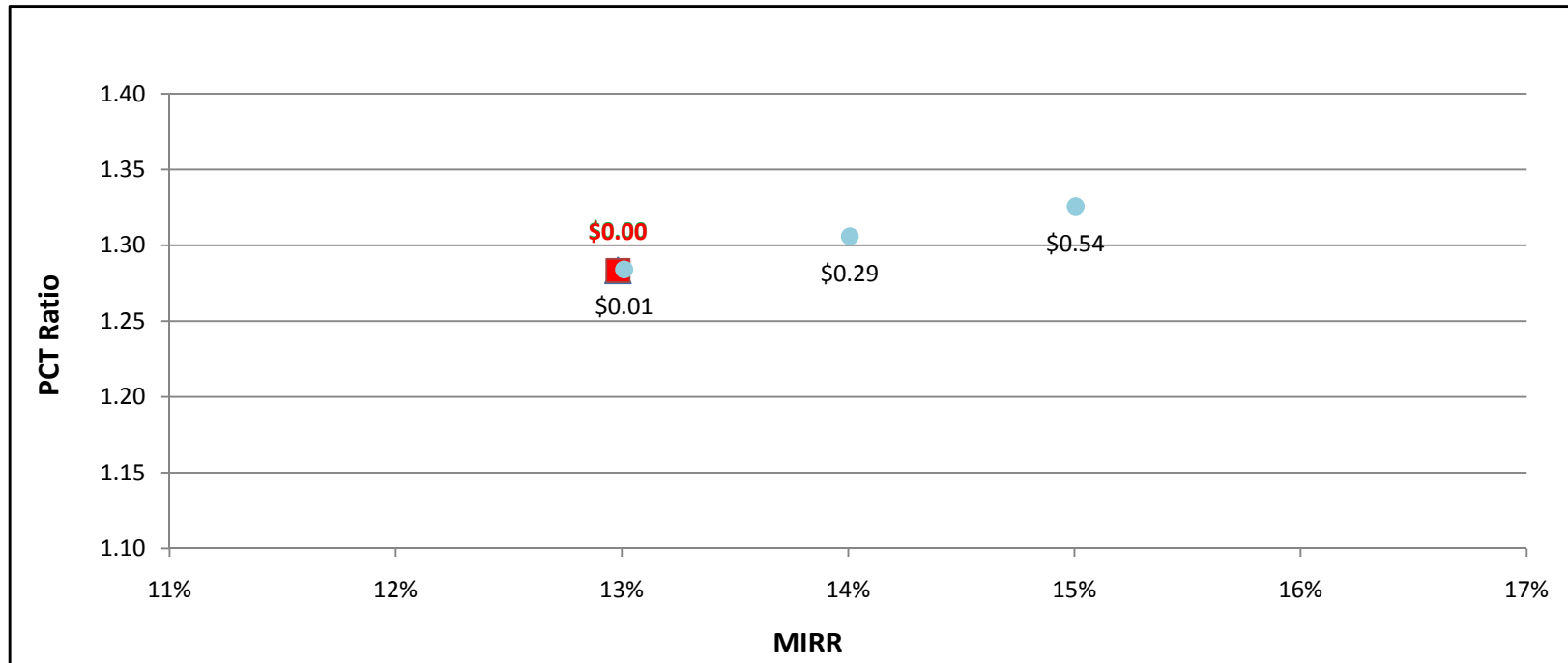

SGIP Cost Effectiveness Report
Participant Test Results (PCT)
MIRR Graphs

GTg2to5MW w/ Natural Gas - Government/Non-Profit - SCE

	Rebate	MIRR	PCT-2010
▲ Actual Rebate - 2010	\$0.00	12.3%	1.24
■ No Rebate	\$0.00	12.3%	1.24
● Rebate to Reach MIRR of 10%	\$0.00	0.0%	0.00
● Rebate to Reach MIRR of 11%	\$0.00	0.0%	0.00
● Rebate to Reach MIRR of 12%	\$0.00	0.0%	0.00
● Rebate to Reach MIRR of 13%	\$0.20	13.0%	1.26
● Rebate to Reach MIRR of 14%	\$0.46	14.0%	1.28
● Rebate to Reach MIRR of 15%	\$0.69	15.0%	1.30

System Cost per Watt: \$2.34

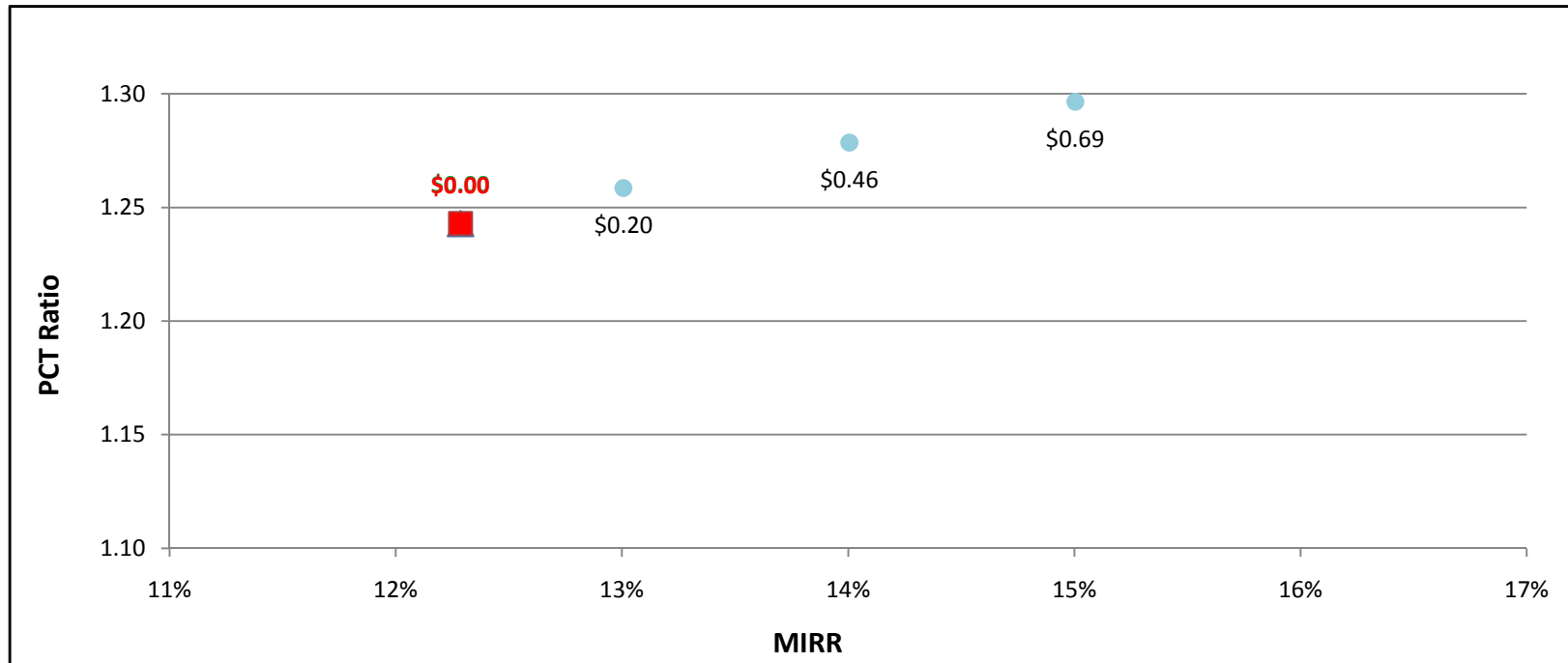

SGIP Cost Effectiveness Report
Participant Test Results (PCT)
MIRR Graphs

GTg2to5MW w/ Natural Gas - Government/Non-Profit - SDG&E

	Rebate	MIRR	PCT-2010
▲ Actual Rebate - 2010	\$0.00	-6.4%	0.93
■ No Rebate	\$0.00	-6.4%	0.93
● Rebate to Reach MIRR of 10%	\$1.57	10.0%	1.04
● Rebate to Reach MIRR of 11%	\$1.66	11.0%	1.05
● Rebate to Reach MIRR of 12%	\$1.74	12.1%	1.06
● Rebate to Reach MIRR of 13%	\$1.81	13.1%	1.06
● Rebate to Reach MIRR of 14%	\$1.87	14.1%	1.07
● Rebate to Reach MIRR of 15%	\$1.93	15.0%	1.07

System Cost per Watt: \$2.34

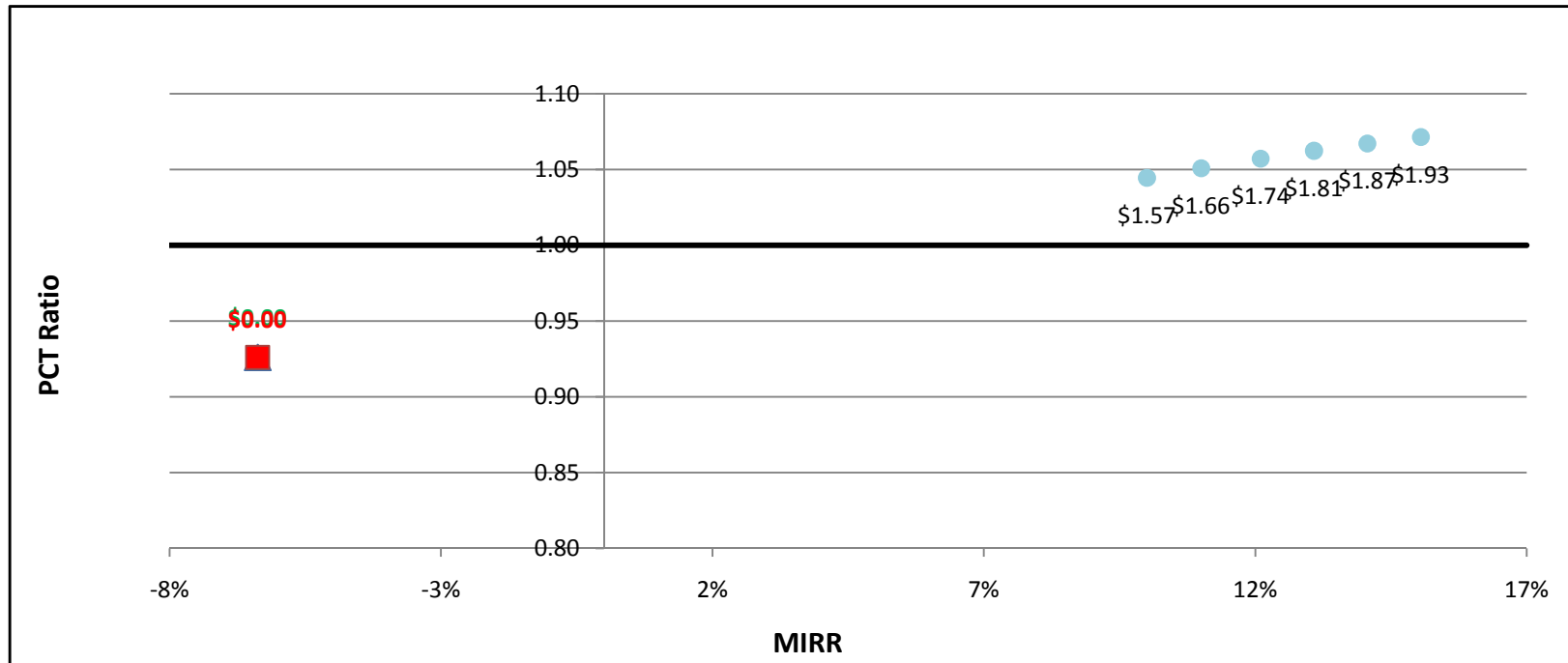

SGIP Cost Effectiveness Report
Participant Test Results (PCT)
MIRR Graphs

GTg2to5MW w/ On-Site BioGas - Government/Non-Profit - PG&E

	Rebate	MIRR	PCT-2010
▲ Actual Rebate - 2010	\$0.00	15.7%	2.06
■ No Rebate	\$0.00	15.7%	2.06
● Rebate to Reach MIRR of 10%	\$0.00	0.0%	0.00
● Rebate to Reach MIRR of 11%	\$0.00	0.0%	0.00
● Rebate to Reach MIRR of 12%	\$0.00	0.0%	0.00
● Rebate to Reach MIRR of 13%	\$0.00	0.0%	0.00
● Rebate to Reach MIRR of 14%	\$0.00	0.0%	0.00
● Rebate to Reach MIRR of 15%	\$0.00	0.0%	0.00

System Cost per Watt: \$2.52

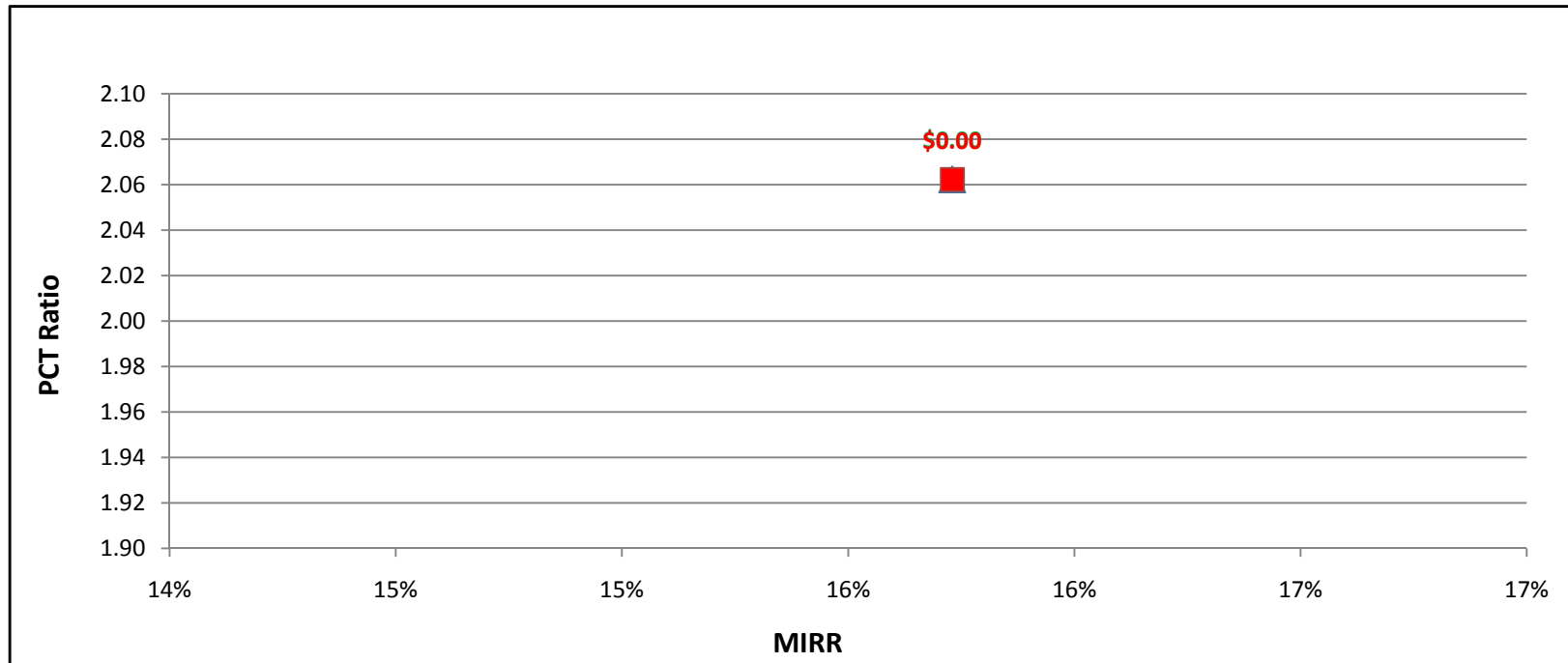

SGIP Cost Effectiveness Report
Participant Test Results (PCT)
MIRR Graphs

GTg2to5MW w/ On-Site BioGas - Government/Non-Profit - SCE

	Rebate	MIRR	PCT-2010
▲ Actual Rebate - 2010	\$0.00	15.5%	2.02
■ No Rebate	\$0.00	15.5%	2.02
● Rebate to Reach MIRR of 10%	\$0.00	0.0%	0.00
● Rebate to Reach MIRR of 11%	\$0.00	0.0%	0.00
● Rebate to Reach MIRR of 12%	\$0.00	0.0%	0.00
● Rebate to Reach MIRR of 13%	\$0.00	0.0%	0.00
● Rebate to Reach MIRR of 14%	\$0.00	0.0%	0.00
● Rebate to Reach MIRR of 15%	\$0.00	0.0%	0.00

System Cost per Watt: \$2.52

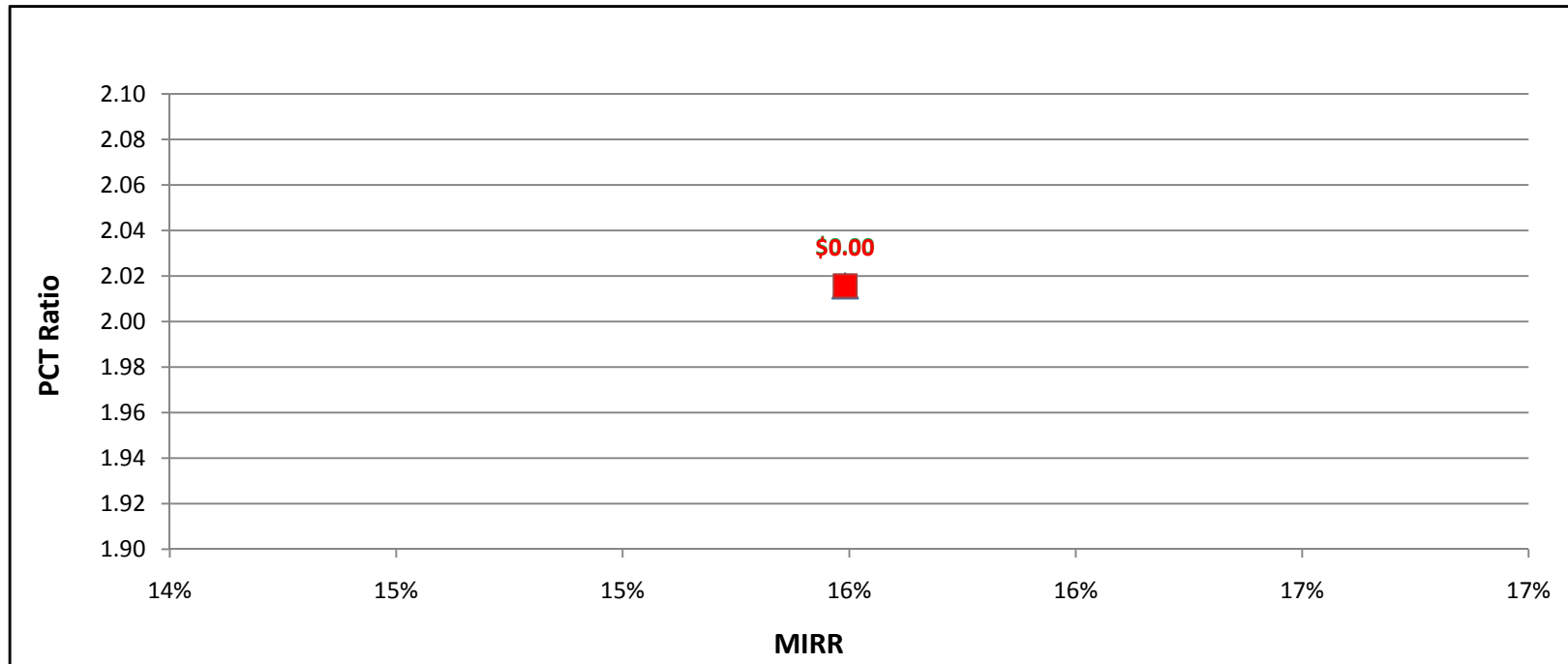

SGIP Cost Effectiveness Report
Participant Test Results (PCT)
MIRR Graphs

GTg2to5MW w/ On-Site BioGas - Government/Non-Profit - SDG&E

	Rebate	MIRR	PCT-2010
▲ Actual Rebate - 2010	\$0.00	12.8%	1.60
■ No Rebate	\$0.00	12.8%	1.60
● Rebate to Reach MIRR of 10%	\$0.00	0.0%	0.00
● Rebate to Reach MIRR of 11%	\$0.00	0.0%	0.00
● Rebate to Reach MIRR of 12%	\$0.00	0.0%	0.00
● Rebate to Reach MIRR of 13%	\$0.10	13.0%	1.61
● Rebate to Reach MIRR of 14%	\$0.52	14.0%	1.65
● Rebate to Reach MIRR of 15%	\$0.93	15.1%	1.70

System Cost per Watt: \$2.52

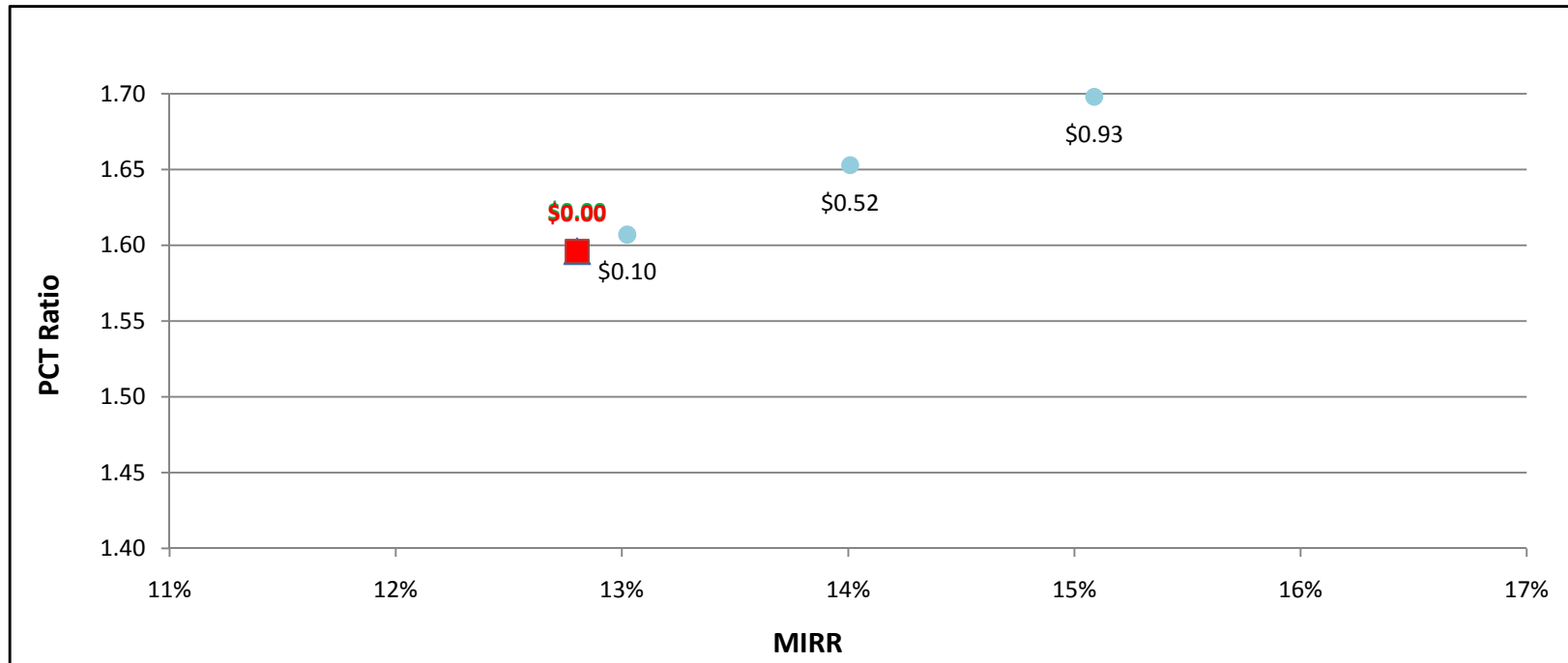

SGIP Cost Effectiveness Report
Participant Test Results (PCT)
MIRR Graphs

GTg2to5MW w/ Directed BioGas - Commercial - PG&E

	Rebate	MIRR	PCT-2010
▲ Actual Rebate - 2010	\$0.00	6.8%	0.95
■ No Rebate	\$0.00	6.8%	0.95
● Rebate to Reach MIRR of 10%	\$0.96	10.1%	0.99
● Rebate to Reach MIRR of 11%	\$1.32	10.9%	1.01
● Rebate to Reach MIRR of 12%	\$1.82	12.0%	1.03
● Rebate to Reach MIRR of 13%	\$0.00	0.0%	0.00
● Rebate to Reach MIRR of 14%	\$0.00	0.0%	0.00
● Rebate to Reach MIRR of 15%	\$0.00	0.0%	0.00

System Cost per Watt: \$2.34

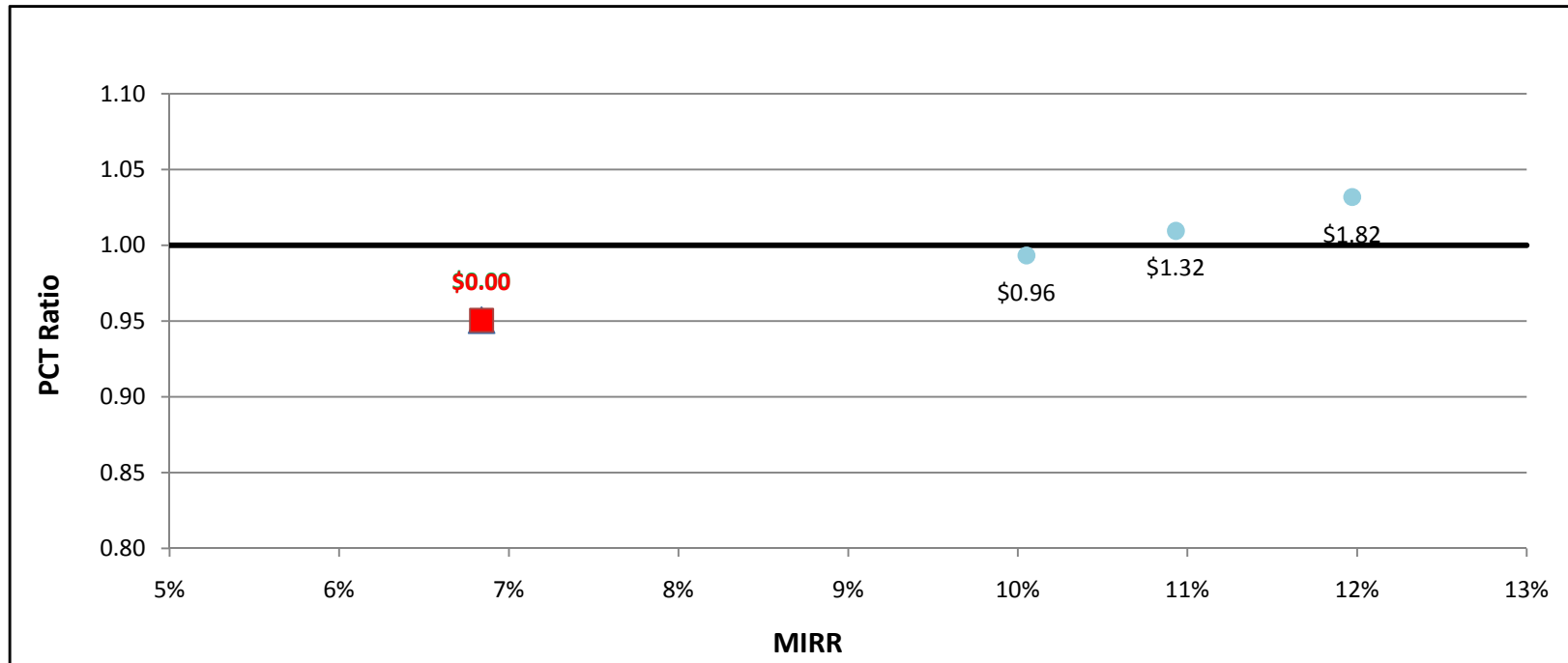

SGIP Cost Effectiveness Report
 Participant Test Results (PCT)
 MIRR Graphs

GTg2to5MW w/ Directed BioGas - Commercial - SCE

	Rebate	MIRR	PCT-2010
▲ Actual Rebate - 2010	\$0.00	5.8%	0.94
■ No Rebate	\$0.00	5.8%	0.94
● Rebate to Reach MIRR of 10%	\$1.23	10.0%	0.99
● Rebate to Reach MIRR of 11%	\$1.63	10.9%	1.01
● Rebate to Reach MIRR of 12%	\$2.18	12.0%	1.03
● Rebate to Reach MIRR of 13%	\$0.00	0.0%	0.00
● Rebate to Reach MIRR of 14%	\$0.00	0.0%	0.00
● Rebate to Reach MIRR of 15%	\$0.00	0.0%	0.00

System Cost per Watt: \$2.34

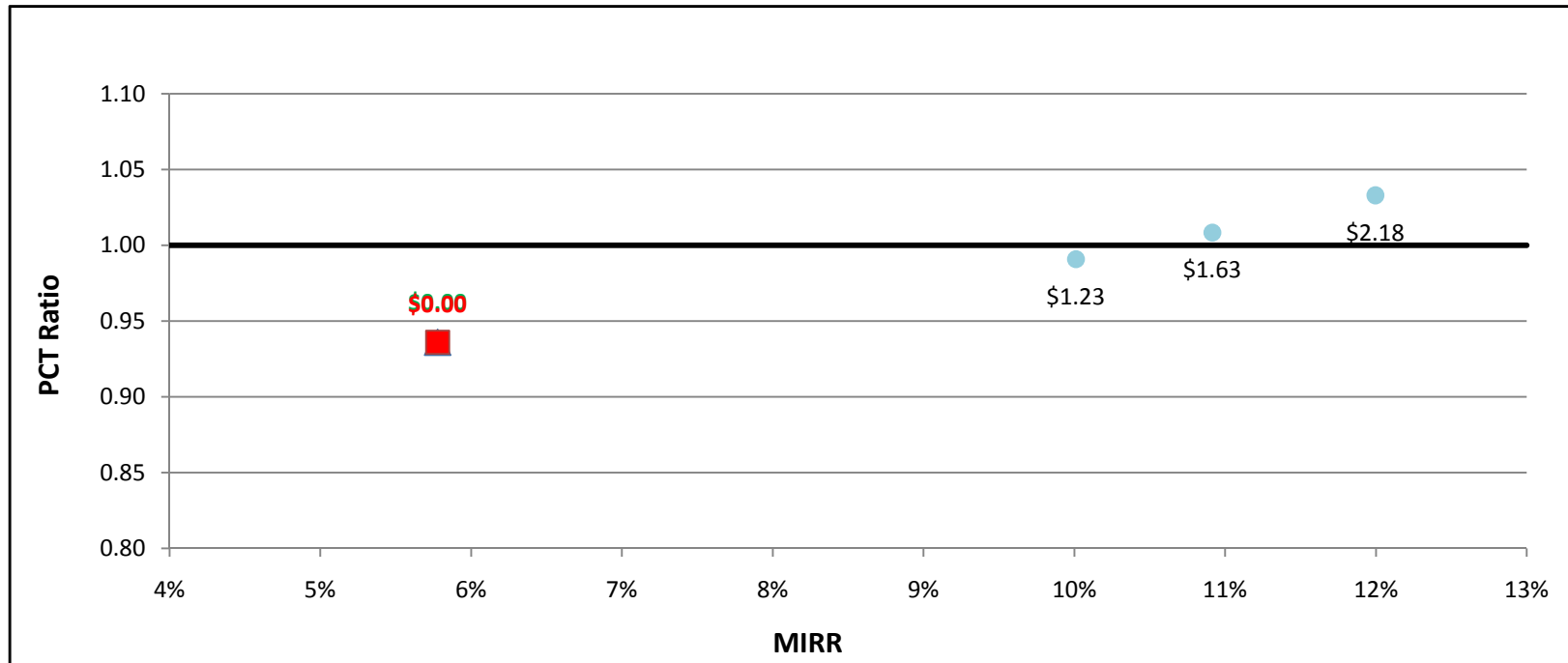

SGIP Cost Effectiveness Report
Participant Test Results (PCT)
MIRR Graphs

GTg2to5MW w/ Directed BioGas - Commercial - SDG&E

	Rebate	MIRR	PCT-2010
▲ Actual Rebate - 2010	\$0.00	-3.9%	0.81
■ No Rebate	\$0.00	-3.9%	0.81
● Rebate to Reach MIRR of 10%	\$0.00	0.0%	0.00
● Rebate to Reach MIRR of 11%	\$0.00	0.0%	0.00
● Rebate to Reach MIRR of 12%	\$0.00	0.0%	0.00
● Rebate to Reach MIRR of 13%	\$0.00	0.0%	0.00
● Rebate to Reach MIRR of 14%	\$0.00	0.0%	0.00
● Rebate to Reach MIRR of 15%	\$0.00	0.0%	0.00

System Cost per Watt: \$2.34

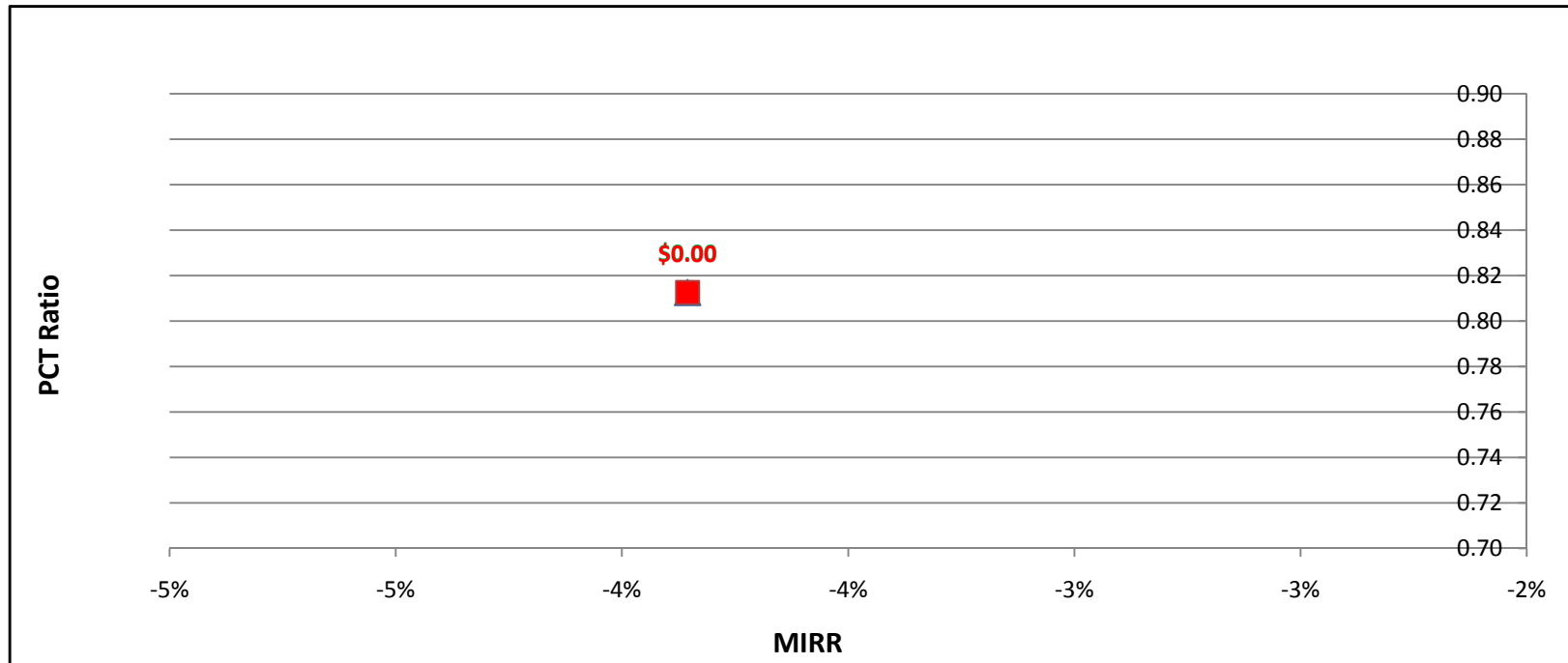

SGIP Cost Effectiveness Report
Participant Test Results (PCT)
MIRR Graphs

GTg2to5MW w/ Natural Gas - Commercial - PG&E

	Rebate	MIRR	PCT-2010
▲ Actual Rebate - 2010	\$0.00	12.2%	1.07
■ No Rebate	\$0.00	12.2%	1.07
● Rebate to Reach MIRR of 10%	\$0.00	0.0%	0.00
● Rebate to Reach MIRR of 11%	\$0.00	0.0%	0.00
● Rebate to Reach MIRR of 12%	\$0.00	0.0%	0.00
● Rebate to Reach MIRR of 13%	\$0.41	12.9%	1.10
● Rebate to Reach MIRR of 14%	\$1.03	13.9%	1.14
● Rebate to Reach MIRR of 15%	\$1.83	15.0%	1.19

System Cost per Watt: \$2.34

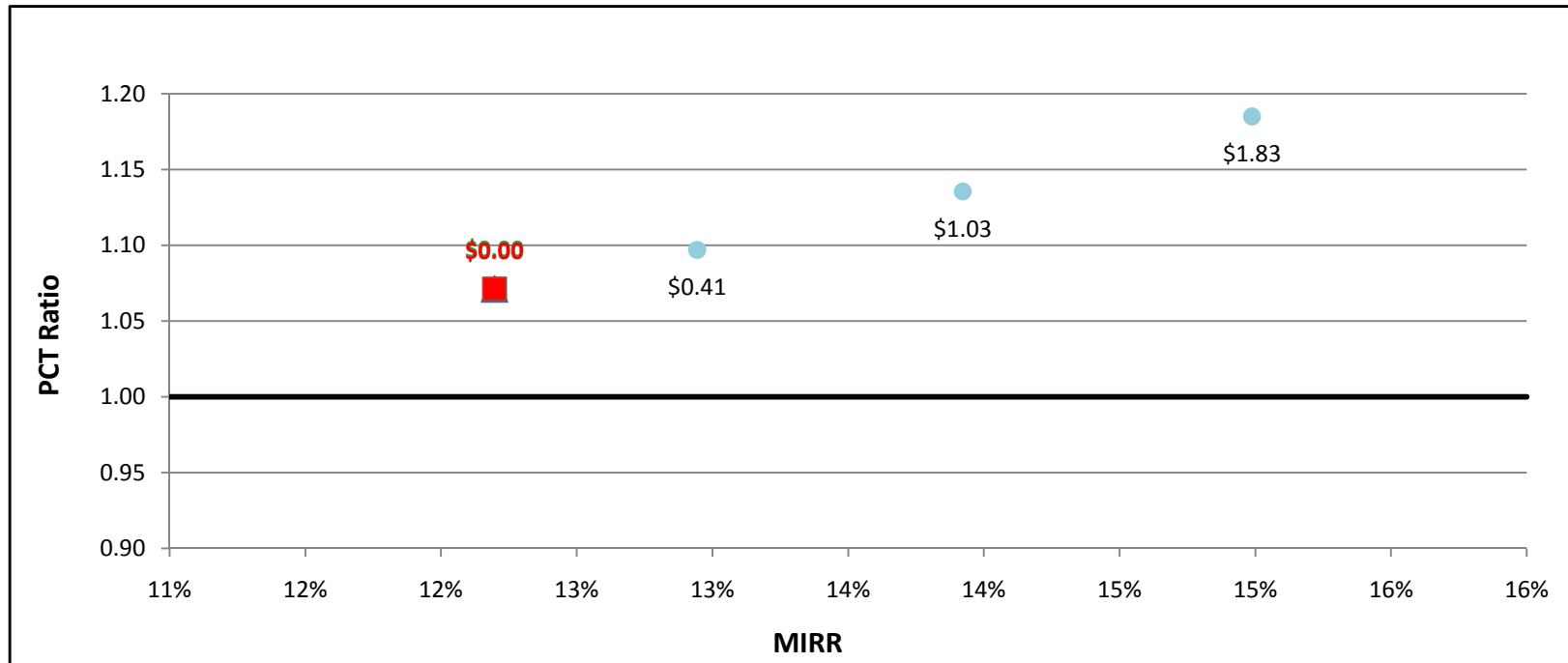

SGIP Cost Effectiveness Report
Participant Test Results (PCT)
MIRR Graphs

GTg2to5MW w/ Natural Gas - Commercial - SCE

	Rebate	MIRR	PCT-2010
▲ Actual Rebate - 2010	\$0.00	11.6%	1.05
■ No Rebate	\$0.00	11.6%	1.05
● Rebate to Reach MIRR of 10%	\$0.00	0.0%	0.00
● Rebate to Reach MIRR of 11%	\$0.00	0.0%	0.00
● Rebate to Reach MIRR of 12%	\$0.18	12.0%	1.06
● Rebate to Reach MIRR of 13%	\$0.67	12.9%	1.09
● Rebate to Reach MIRR of 14%	\$1.34	14.0%	1.13
● Rebate to Reach MIRR of 15%	\$2.11	15.0%	1.18

System Cost per Watt: \$2.34

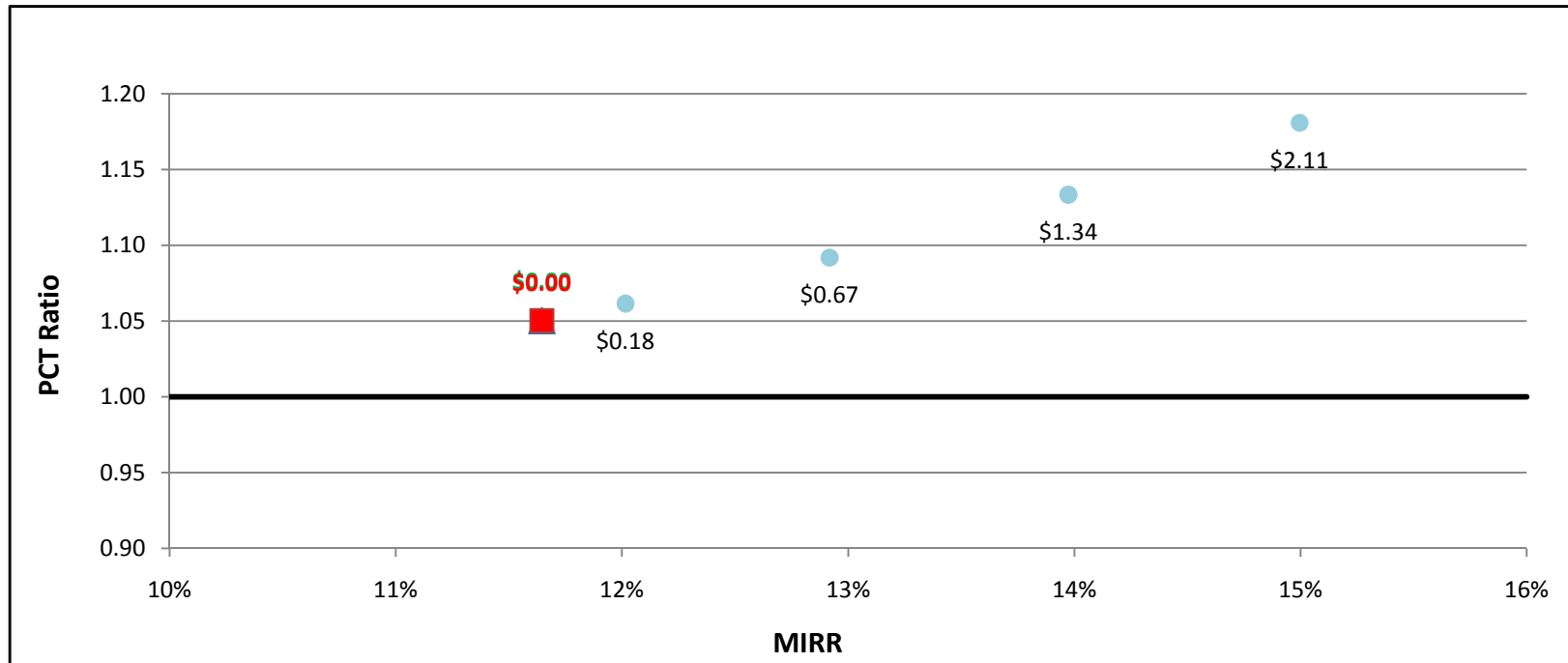

SGIP Cost Effectiveness Report
Participant Test Results (PCT)
MIRR Graphs

GTg2to5MW w/ Natural Gas - Commercial - SDG&E

	Rebate	MIRR	PCT-2010
▲ Actual Rebate - 2010	\$0.00	4.5%	0.88
■ No Rebate	\$0.00	4.5%	0.88
● Rebate to Reach MIRR of 10%	\$1.72	9.9%	0.98
● Rebate to Reach MIRR of 11%	\$2.32	11.1%	1.02
● Rebate to Reach MIRR of 12%	\$0.00	0.0%	0.00
● Rebate to Reach MIRR of 13%	\$0.00	0.0%	0.00
● Rebate to Reach MIRR of 14%	\$0.00	0.0%	0.00
● Rebate to Reach MIRR of 15%	\$0.00	0.0%	0.00

System Cost per Watt: \$2.34

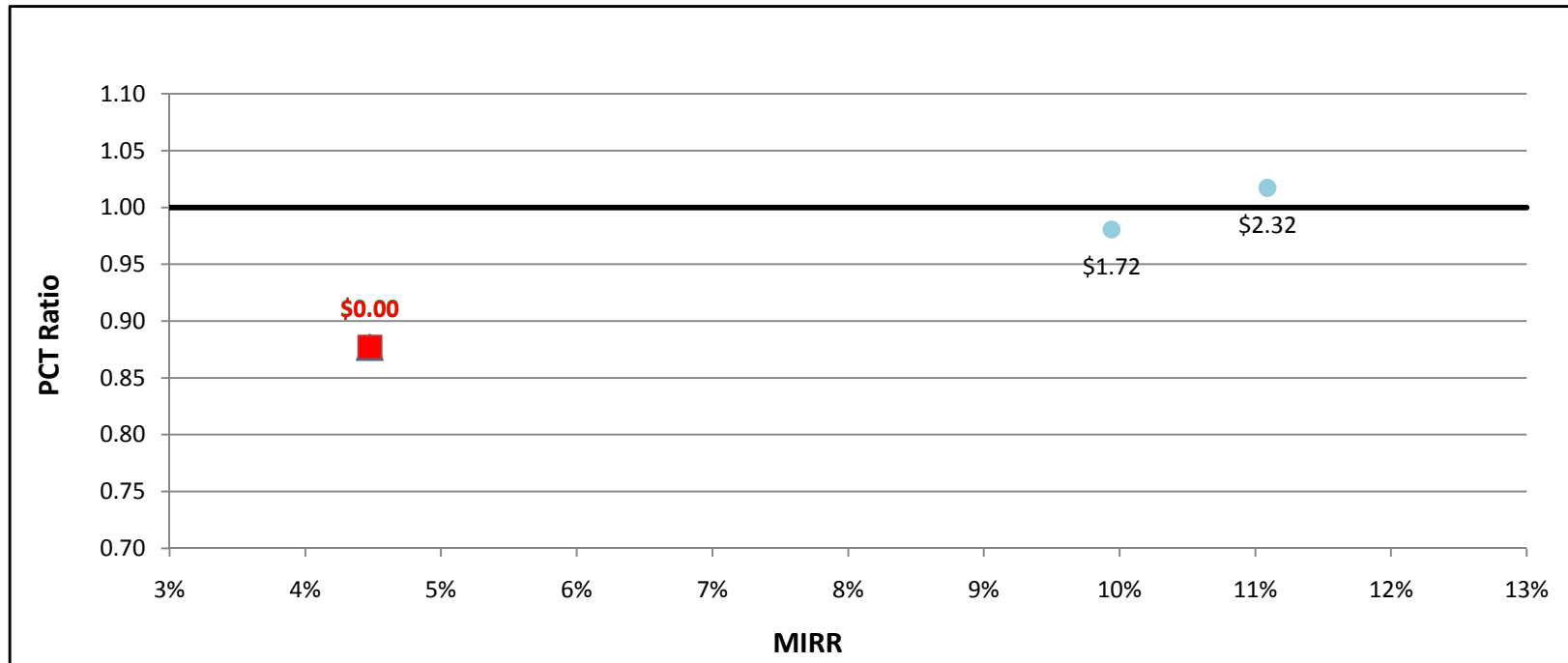

SGIP Cost Effectiveness Report
Participant Test Results (PCT)
MIRR Graphs

GTg2to5MW w/ On-Site BioGas - Commercial - PG&E

	Rebate	MIRR	PCT-2010
▲ Actual Rebate - 2010	\$0.00	14.8%	1.40
■ No Rebate	\$0.00	14.8%	1.40
● Rebate to Reach MIRR of 10%	\$0.00	0.0%	0.00
● Rebate to Reach MIRR of 11%	\$0.00	0.0%	0.00
● Rebate to Reach MIRR of 12%	\$0.00	0.0%	0.00
● Rebate to Reach MIRR of 13%	\$0.00	0.0%	0.00
● Rebate to Reach MIRR of 14%	\$0.00	0.0%	0.00
● Rebate to Reach MIRR of 15%	\$0.18	15.0%	1.42

System Cost per Watt: \$2.52

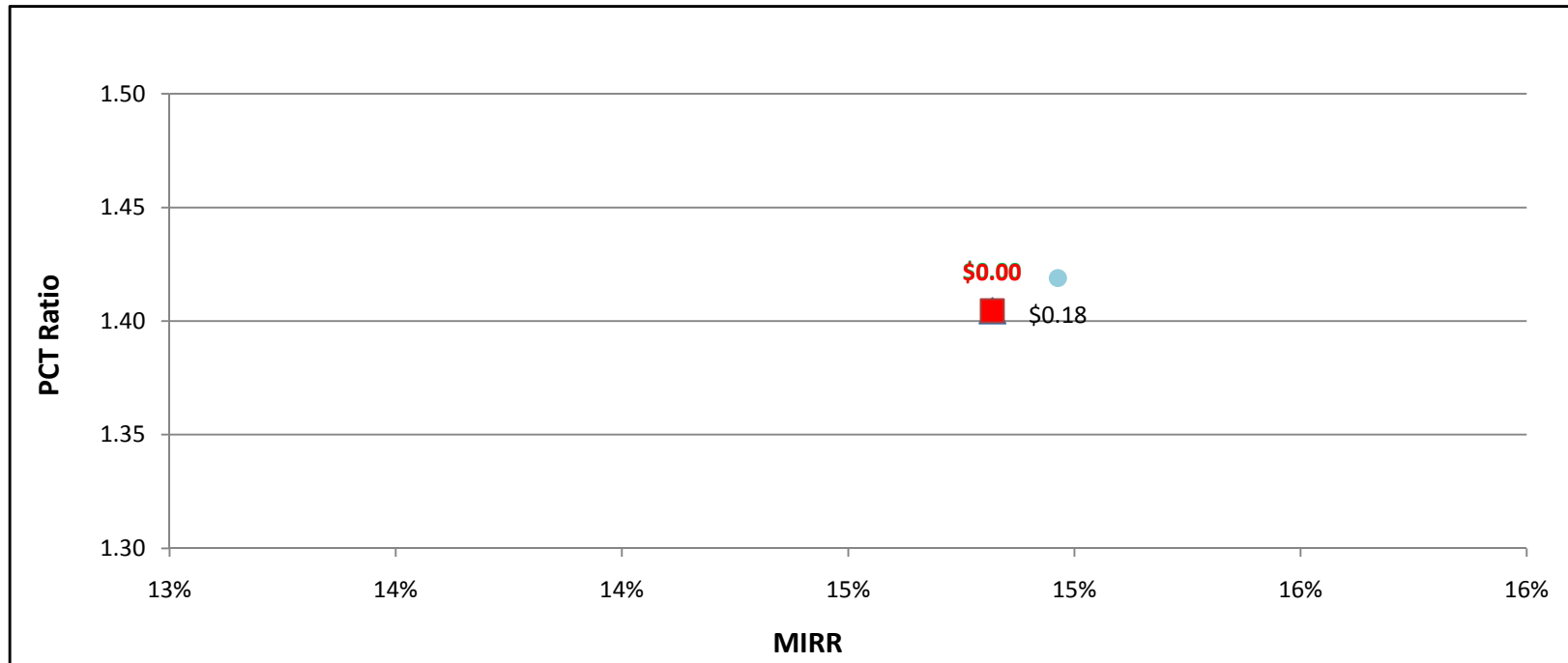

SGIP Cost Effectiveness Report
Participant Test Results (PCT)
MIRR Graphs

GTg2to5MW w/ On-Site BioGas - Commercial - SCE

	Rebate	MIRR	PCT-2010
▲ Actual Rebate - 2010	\$0.00	14.6%	1.38
■ No Rebate	\$0.00	14.6%	1.38
● Rebate to Reach MIRR of 10%	\$0.00	0.0%	0.00
● Rebate to Reach MIRR of 11%	\$0.00	0.0%	0.00
● Rebate to Reach MIRR of 12%	\$0.00	0.0%	0.00
● Rebate to Reach MIRR of 13%	\$0.00	0.0%	0.00
● Rebate to Reach MIRR of 14%	\$0.00	0.0%	0.00
● Rebate to Reach MIRR of 15%	\$0.43	15.0%	1.42

System Cost per Watt: \$2.52

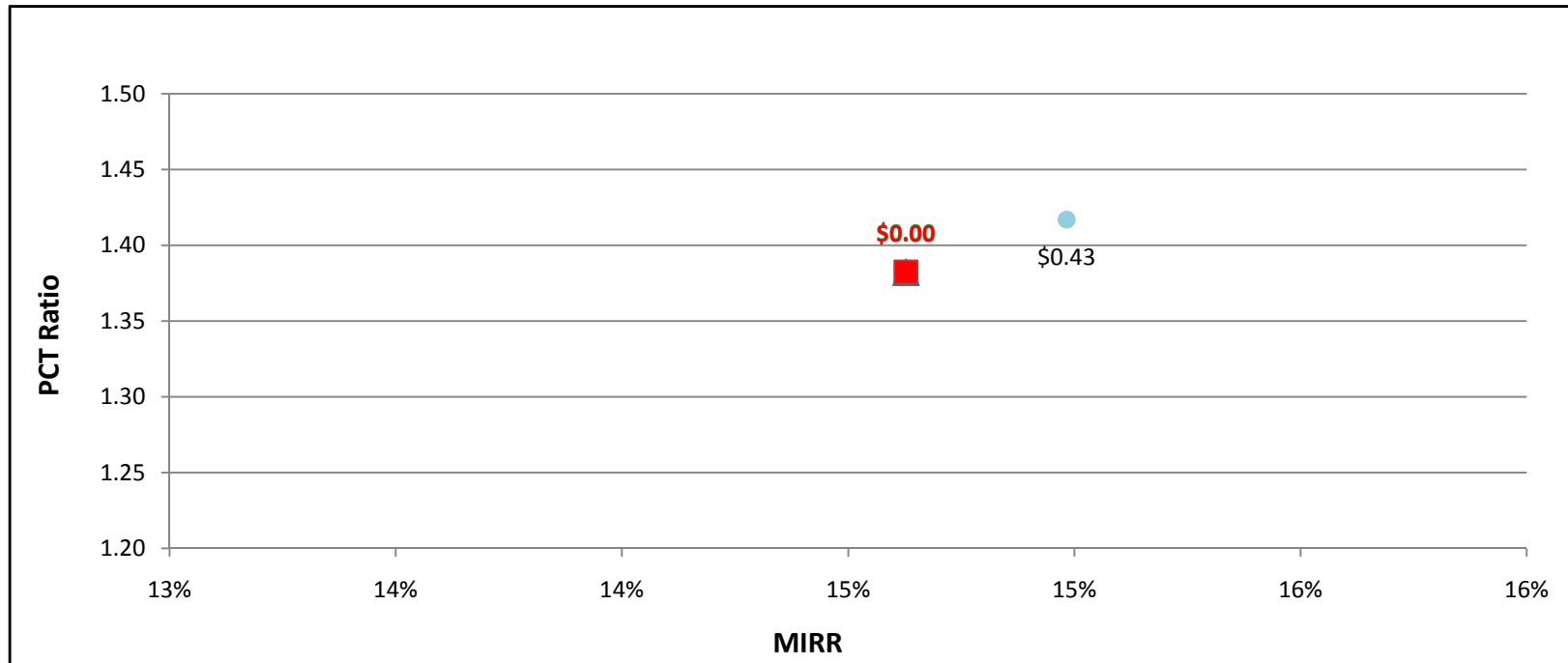

SGIP Cost Effectiveness Report
 Participant Test Results (PCT)
 MIRR Graphs

GTg2to5MW w/ On-Site BioGas - Commercial - SDG&E

	Rebate	MIRR	PCT-2010
▲ Actual Rebate - 2010	\$0.00	12.4%	1.17
■ No Rebate	\$0.00	12.4%	1.17
● Rebate to Reach MIRR of 10%	\$0.00	0.0%	0.00
● Rebate to Reach MIRR of 11%	\$0.00	0.0%	0.00
● Rebate to Reach MIRR of 12%	\$0.00	0.0%	0.00
● Rebate to Reach MIRR of 13%	\$0.46	13.0%	1.21
● Rebate to Reach MIRR of 14%	\$1.46	14.0%	1.29
● Rebate to Reach MIRR of 15%	\$0.00	0.0%	0.00

System Cost per Watt: \$2.52

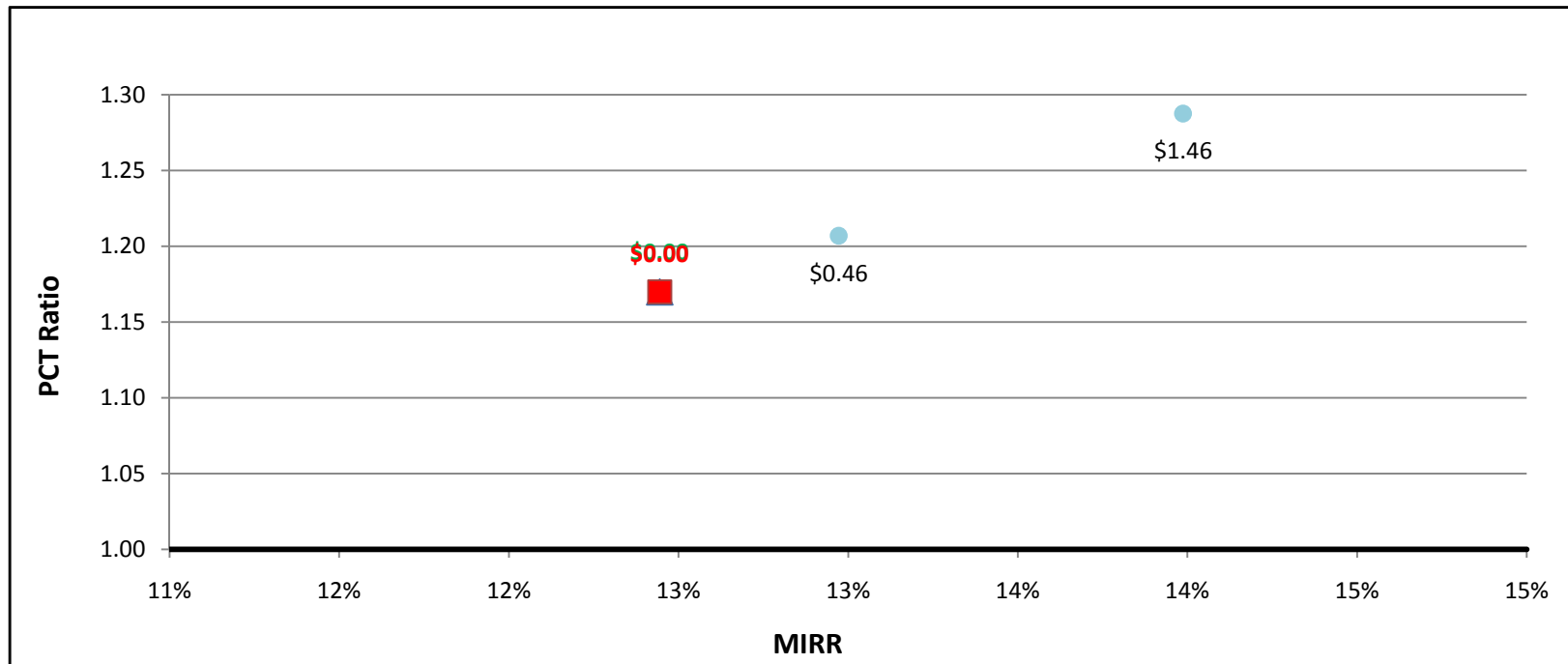

SGIP Cost Effectiveness Report
Participant Test Results (PCT)
MIRR Graphs

GTle2MW w/ Directed BioGas - Government/Non-Profit - PG&E

	Rebate	MIRR	PCT-2010
▲ Actual Rebate - 2010	\$0.00	-100.0%	0.76
■ No Rebate	\$0.00	-100.0%	0.76
● Rebate to Reach MIRR of 10%	\$0.00	0.0%	0.00
● Rebate to Reach MIRR of 11%	\$0.00	0.0%	0.00
● Rebate to Reach MIRR of 12%	\$0.00	0.0%	0.00
● Rebate to Reach MIRR of 13%	\$0.00	0.0%	0.00
● Rebate to Reach MIRR of 14%	\$0.00	0.0%	0.00
● Rebate to Reach MIRR of 15%	\$0.00	0.0%	0.00

System Cost per Watt: \$4.20

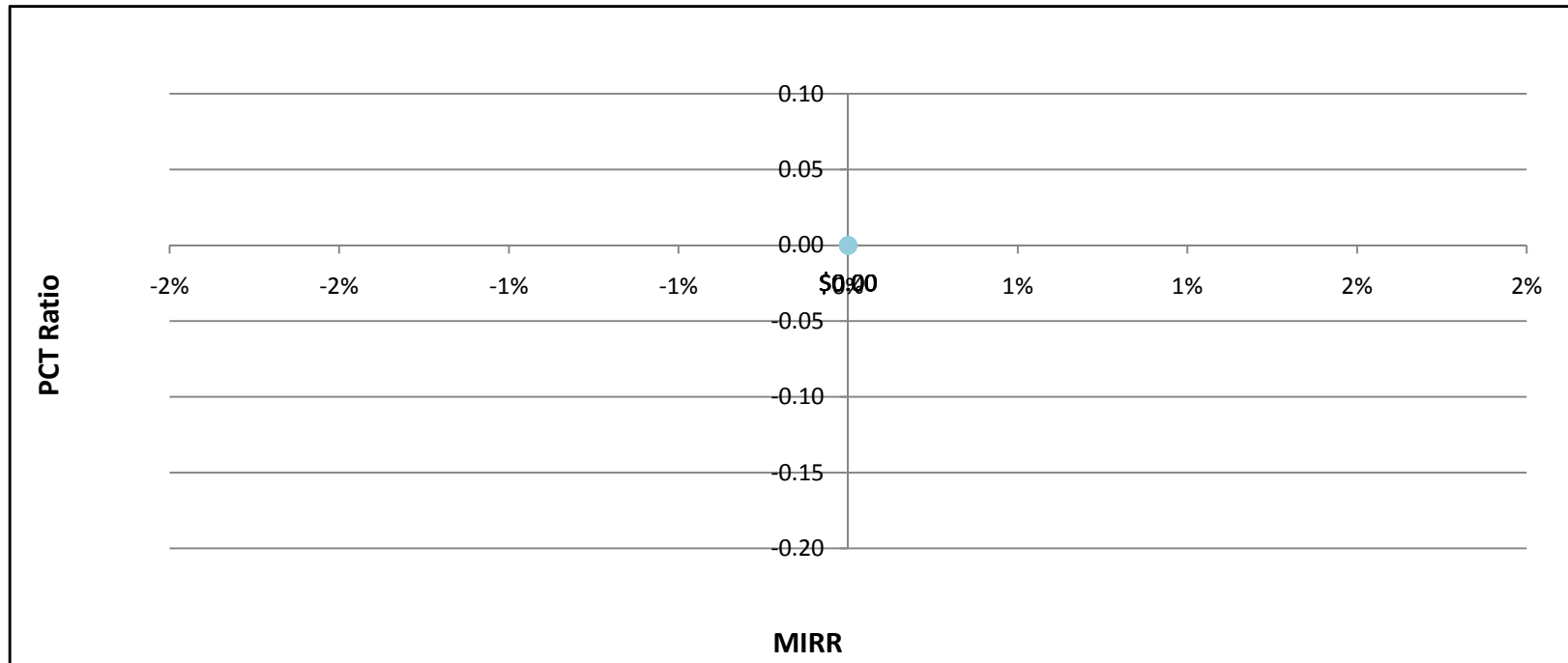

SGIP Cost Effectiveness Report
Participant Test Results (PCT)
MIRR Graphs

GTle2MW w/ Directed BioGas - Government/Non-Profit - SCE

	Rebate	MIRR	PCT-2010
▲ Actual Rebate - 2010	\$0.00	-100.0%	0.74
■ No Rebate	\$0.00	-100.0%	0.74
● Rebate to Reach MIRR of 10%	\$0.00	0.0%	0.00
● Rebate to Reach MIRR of 11%	\$0.00	0.0%	0.00
● Rebate to Reach MIRR of 12%	\$0.00	0.0%	0.00
● Rebate to Reach MIRR of 13%	\$0.00	0.0%	0.00
● Rebate to Reach MIRR of 14%	\$0.00	0.0%	0.00
● Rebate to Reach MIRR of 15%	\$0.00	0.0%	0.00

System Cost per Watt: \$4.20

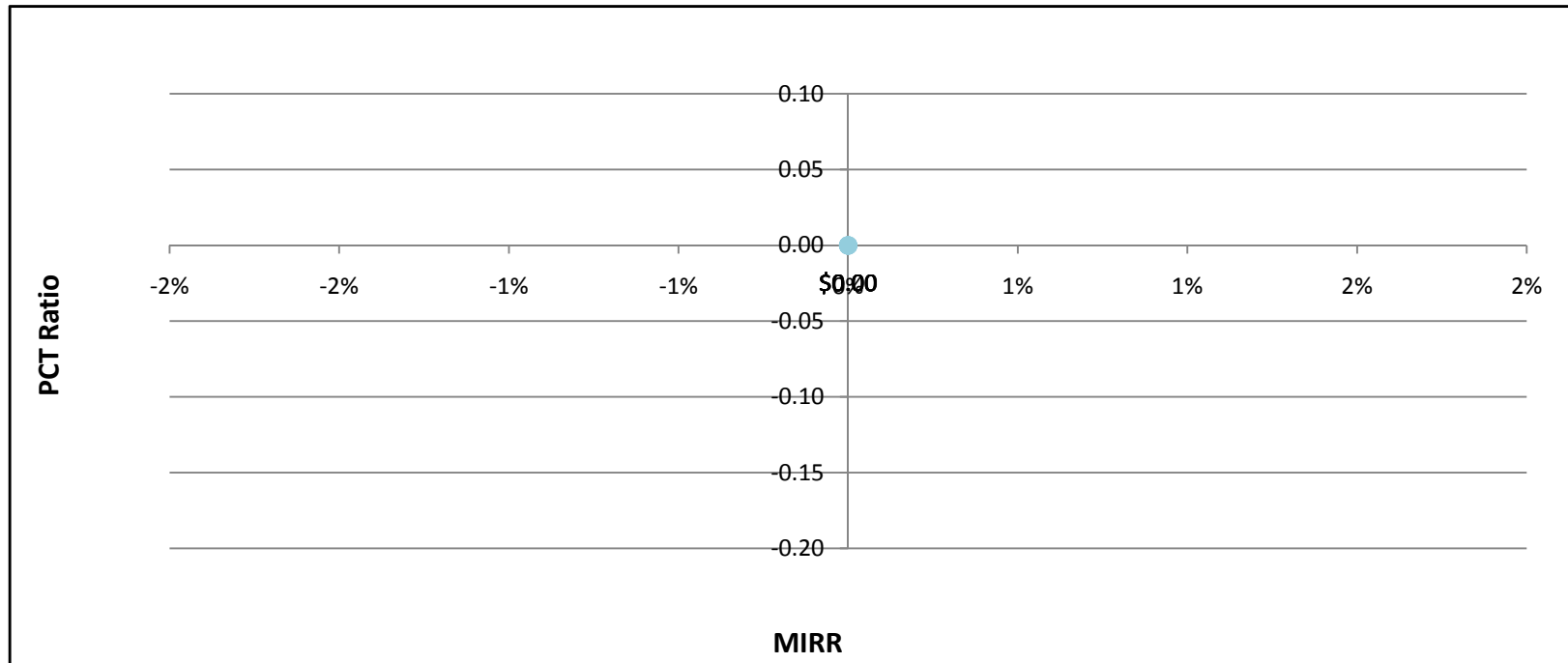

SGIP Cost Effectiveness Report
 Participant Test Results (PCT)
 MIRR Graphs

GTle2MW w/ Directed BioGas - Government/Non-Profit - SDG&E

	Rebate	MIRR	PCT-2010
▲ Actual Rebate - 2010	\$0.00	-100.0%	0.57
■ No Rebate	\$0.00	-100.0%	0.57
● Rebate to Reach MIRR of 10%	\$0.00	0.0%	0.00
● Rebate to Reach MIRR of 11%	\$0.00	0.0%	0.00
● Rebate to Reach MIRR of 12%	\$0.00	0.0%	0.00
● Rebate to Reach MIRR of 13%	\$0.00	0.0%	0.00
● Rebate to Reach MIRR of 14%	\$0.00	0.0%	0.00
● Rebate to Reach MIRR of 15%	\$0.00	0.0%	0.00

System Cost per Watt: \$4.20

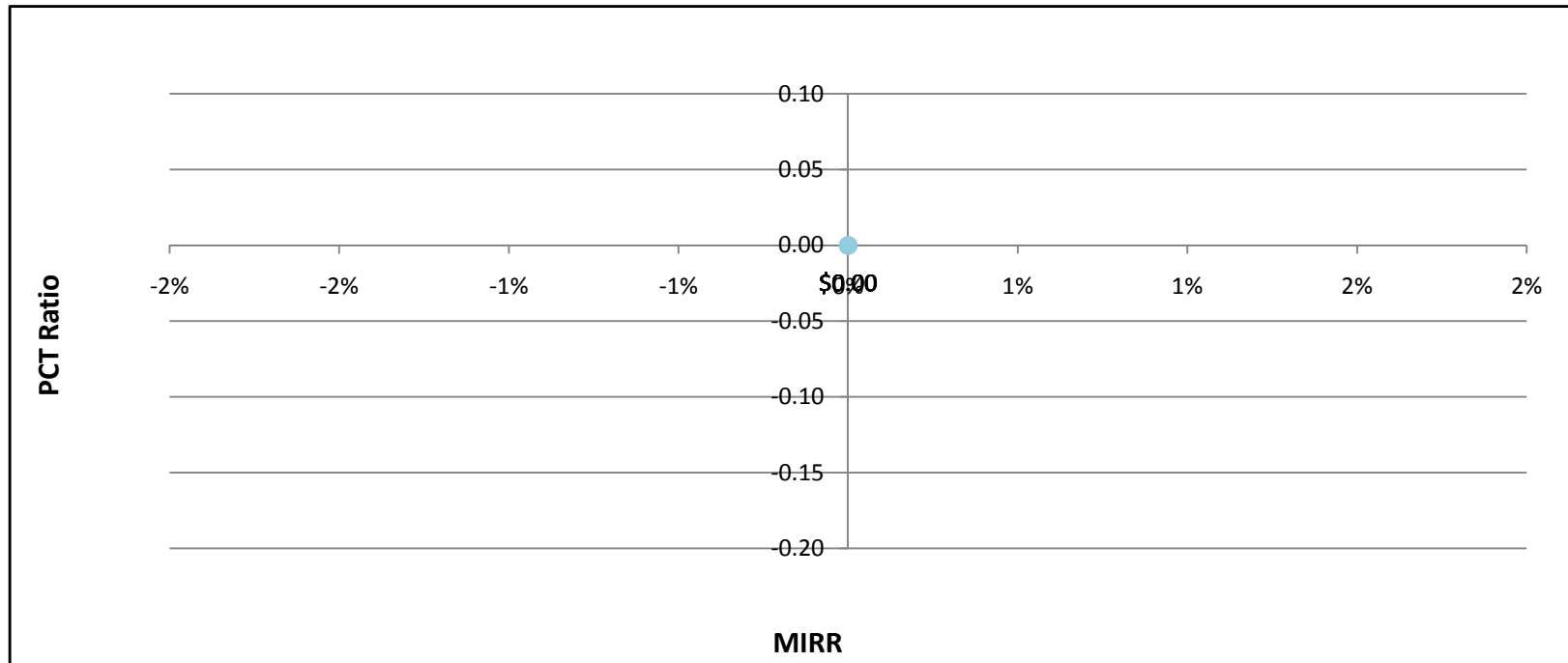

SGIP Cost Effectiveness Report
 Participant Test Results (PCT)
 MIRR Graphs

GTle2MW w/ Natural Gas - Government/Non-Profit - PG&E

	Rebate	MIRR	PCT-2010
▲ Actual Rebate - 2010	\$0.00	-2.8%	0.93
■ No Rebate	\$0.00	-2.8%	0.93
● Rebate to Reach MIRR of 10%	\$2.52	10.0%	1.07
● Rebate to Reach MIRR of 11%	\$2.70	11.0%	1.08
● Rebate to Reach MIRR of 12%	\$2.87	12.0%	1.09
● Rebate to Reach MIRR of 13%	\$3.03	13.0%	1.10
● Rebate to Reach MIRR of 14%	\$3.17	14.0%	1.11
● Rebate to Reach MIRR of 15%	\$3.30	15.0%	1.12

System Cost per Watt: \$4.20

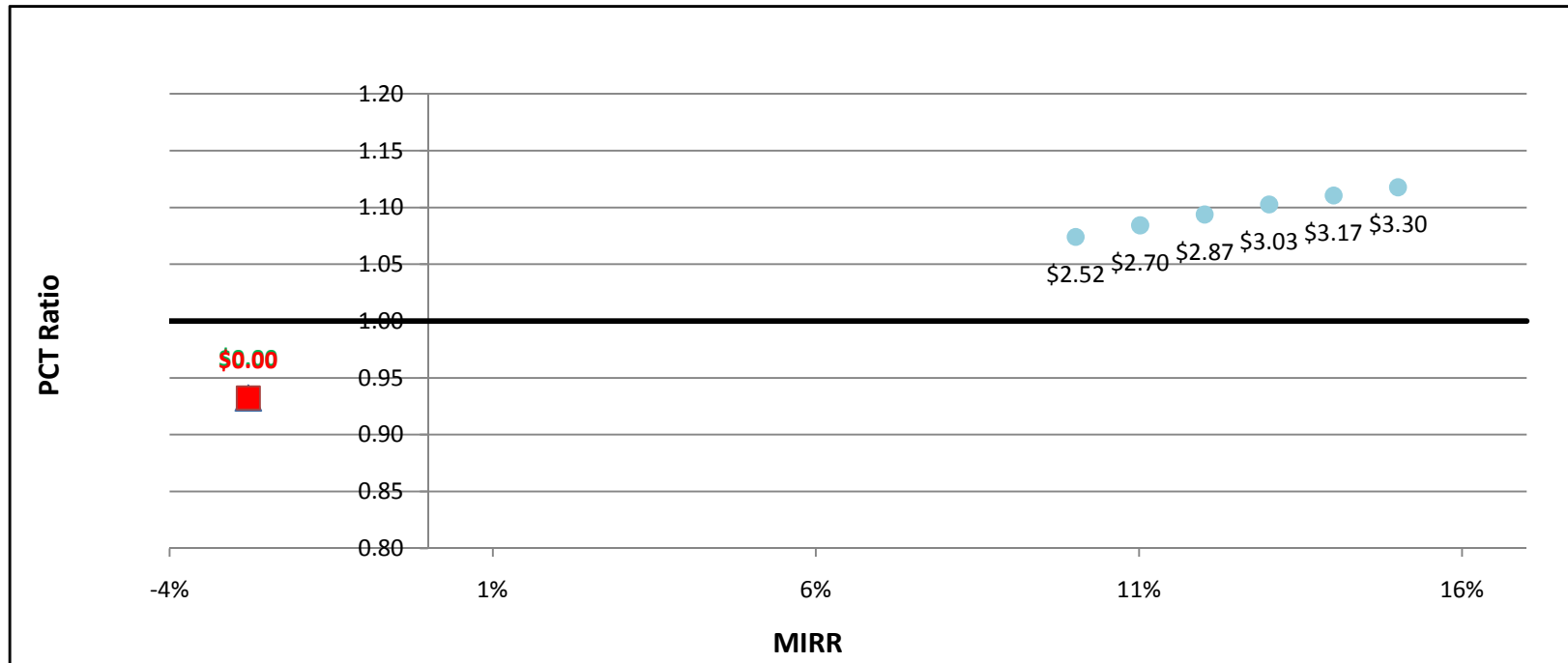

SGIP Cost Effectiveness Report
 Participant Test Results (PCT)
 MIRR Graphs

GTle2MW w/ Natural Gas - Government/Non-Profit - SCE

	Rebate	MIRR	PCT-2010
▲ Actual Rebate - 2010	\$0.00	-6.1%	0.90
■ No Rebate	\$0.00	-6.1%	0.90
● Rebate to Reach MIRR of 10%	\$2.81	10.0%	1.06
● Rebate to Reach MIRR of 11%	\$2.96	11.0%	1.07
● Rebate to Reach MIRR of 12%	\$3.10	12.0%	1.08
● Rebate to Reach MIRR of 13%	\$3.23	13.0%	1.08
● Rebate to Reach MIRR of 14%	\$3.35	14.0%	1.09
● Rebate to Reach MIRR of 15%	\$3.46	15.1%	1.10

System Cost per Watt: \$4.20

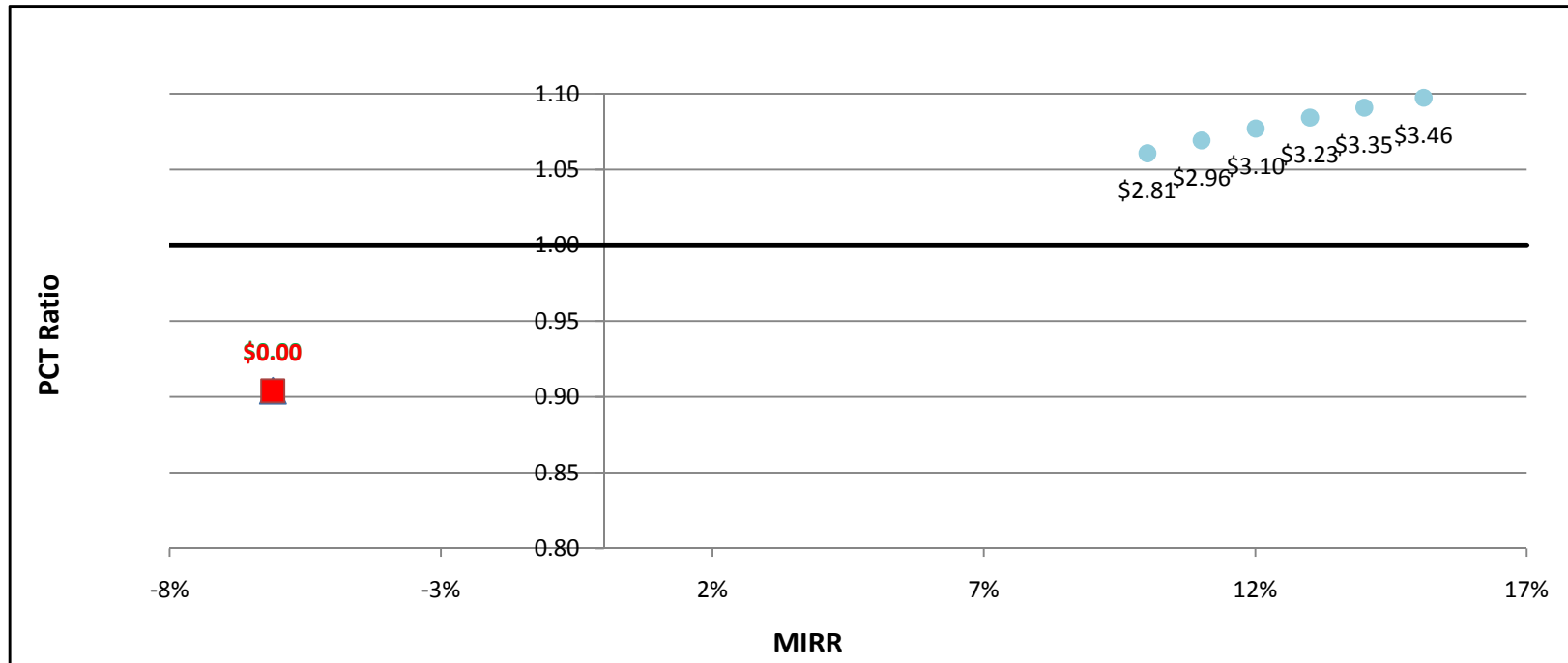

SGIP Cost Effectiveness Report
Participant Test Results (PCT)
MIRR Graphs

GTle2MW w/ Natural Gas - Government/Non-Profit - SDG&E

	Rebate	MIRR	PCT-2010
▲ Actual Rebate - 2010	\$0.00	-100.0%	0.67
■ No Rebate	\$0.00	-100.0%	0.67
● Rebate to Reach MIRR of 10%	\$0.00	0.0%	0.00
● Rebate to Reach MIRR of 11%	\$0.00	0.0%	0.00
● Rebate to Reach MIRR of 12%	\$0.00	0.0%	0.00
● Rebate to Reach MIRR of 13%	\$0.00	0.0%	0.00
● Rebate to Reach MIRR of 14%	\$0.00	0.0%	0.00
● Rebate to Reach MIRR of 15%	\$0.00	0.0%	0.00

System Cost per Watt: \$4.20

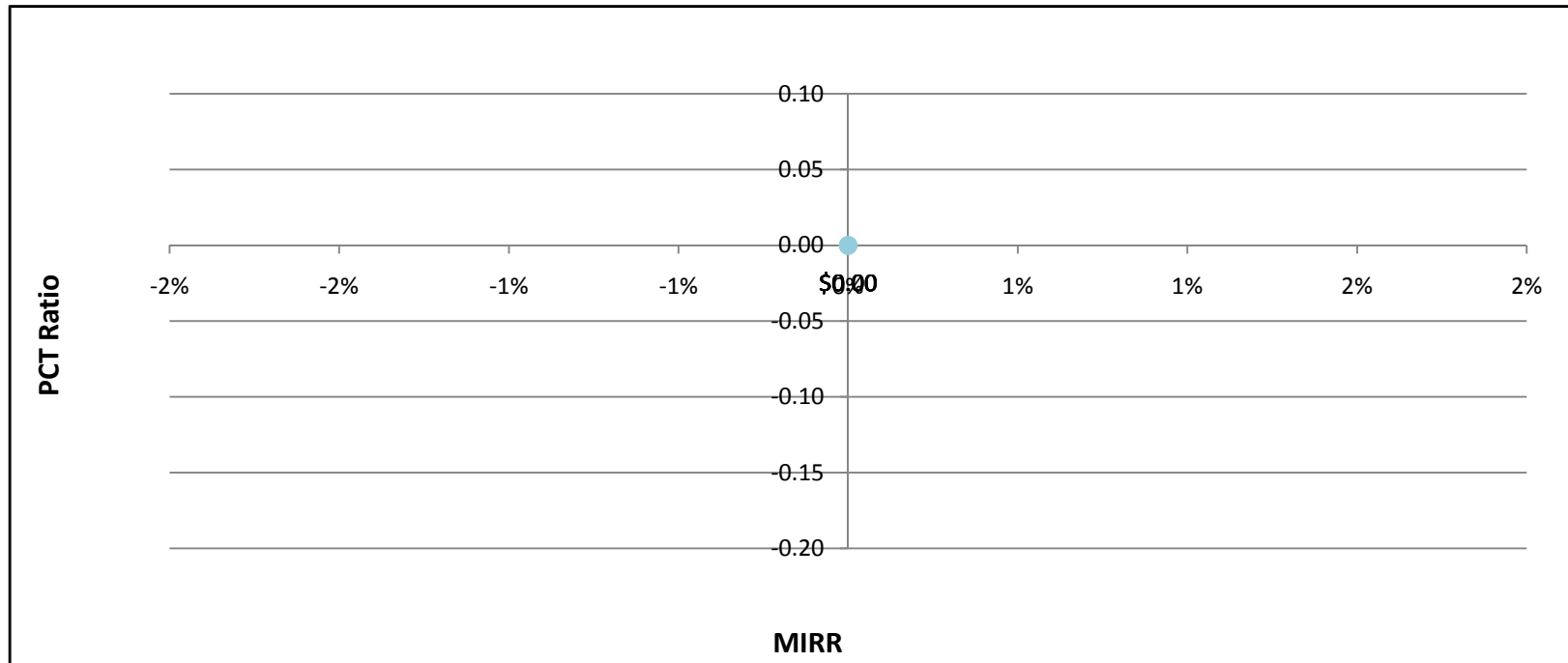

SGIP Cost Effectiveness Report
 Participant Test Results (PCT)
 MIRR Graphs

GTle2MW w/ On-Site BioGas - Government/Non-Profit - PG&E

	Rebate	MIRR	PCT-2010
▲ Actual Rebate - 2010	\$0.00	9.8%	1.34
■ No Rebate	\$0.00	9.8%	1.34
● Rebate to Reach MIRR of 10%	\$0.13	10.0%	1.35
● Rebate to Reach MIRR of 11%	\$0.79	11.0%	1.40
● Rebate to Reach MIRR of 12%	\$1.48	12.1%	1.45
● Rebate to Reach MIRR of 13%	\$2.02	13.0%	1.49
● Rebate to Reach MIRR of 14%	\$2.52	14.0%	1.52
● Rebate to Reach MIRR of 15%	\$3.02	15.1%	1.56

System Cost per Watt: \$4.43

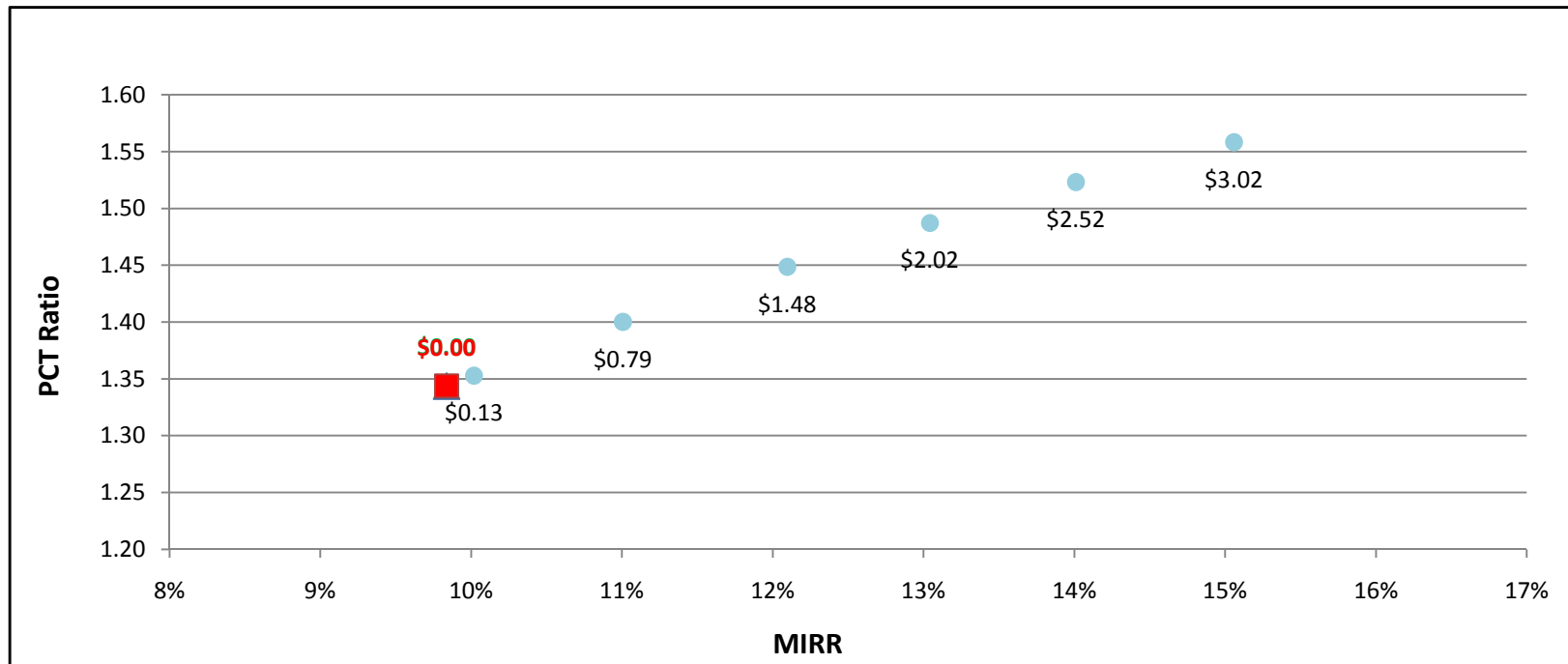

SGIP Cost Effectiveness Report
Participant Test Results (PCT)
MIRR Graphs

GTle2MW w/ On-Site BioGas - Government/Non-Profit - SCE

	Rebate	MIRR	PCT-2010
▲ Actual Rebate - 2010	\$0.00	9.5%	1.32
■ No Rebate	\$0.00	9.5%	1.32
● Rebate to Reach MIRR of 10%	\$0.35	10.0%	1.34
● Rebate to Reach MIRR of 11%	\$0.99	11.0%	1.39
● Rebate to Reach MIRR of 12%	\$1.64	12.1%	1.43
● Rebate to Reach MIRR of 13%	\$2.17	13.0%	1.47
● Rebate to Reach MIRR of 14%	\$2.66	14.0%	1.50
● Rebate to Reach MIRR of 15%	\$3.13	15.0%	1.54

System Cost per Watt: \$4.43

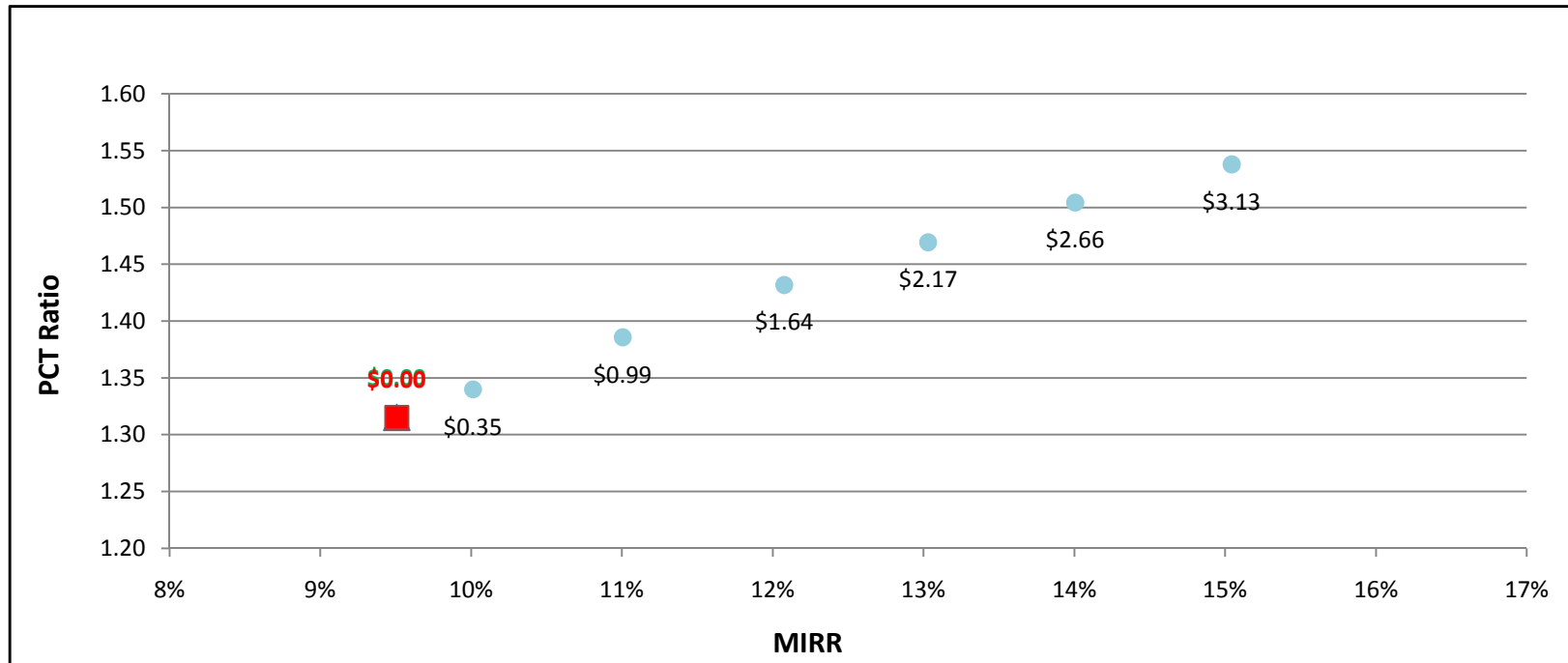

SGIP Cost Effectiveness Report
Participant Test Results (PCT)
MIRR Graphs

GTle2MW w/ On-Site BioGas - Government/Non-Profit - SDG&E

	Rebate	MIRR	PCT-2010
▲ Actual Rebate - 2010	\$0.00	4.6%	1.04
■ No Rebate	\$0.00	4.6%	1.04
● Rebate to Reach MIRR of 10%	\$2.53	10.0%	1.22
● Rebate to Reach MIRR of 11%	\$2.96	11.1%	1.25
● Rebate to Reach MIRR of 12%	\$3.33	12.0%	1.27
● Rebate to Reach MIRR of 13%	\$3.71	13.1%	1.30
● Rebate to Reach MIRR of 14%	\$4.03	14.1%	1.32
● Rebate to Reach MIRR of 15%	\$4.29	15.0%	1.34

System Cost per Watt: \$4.43

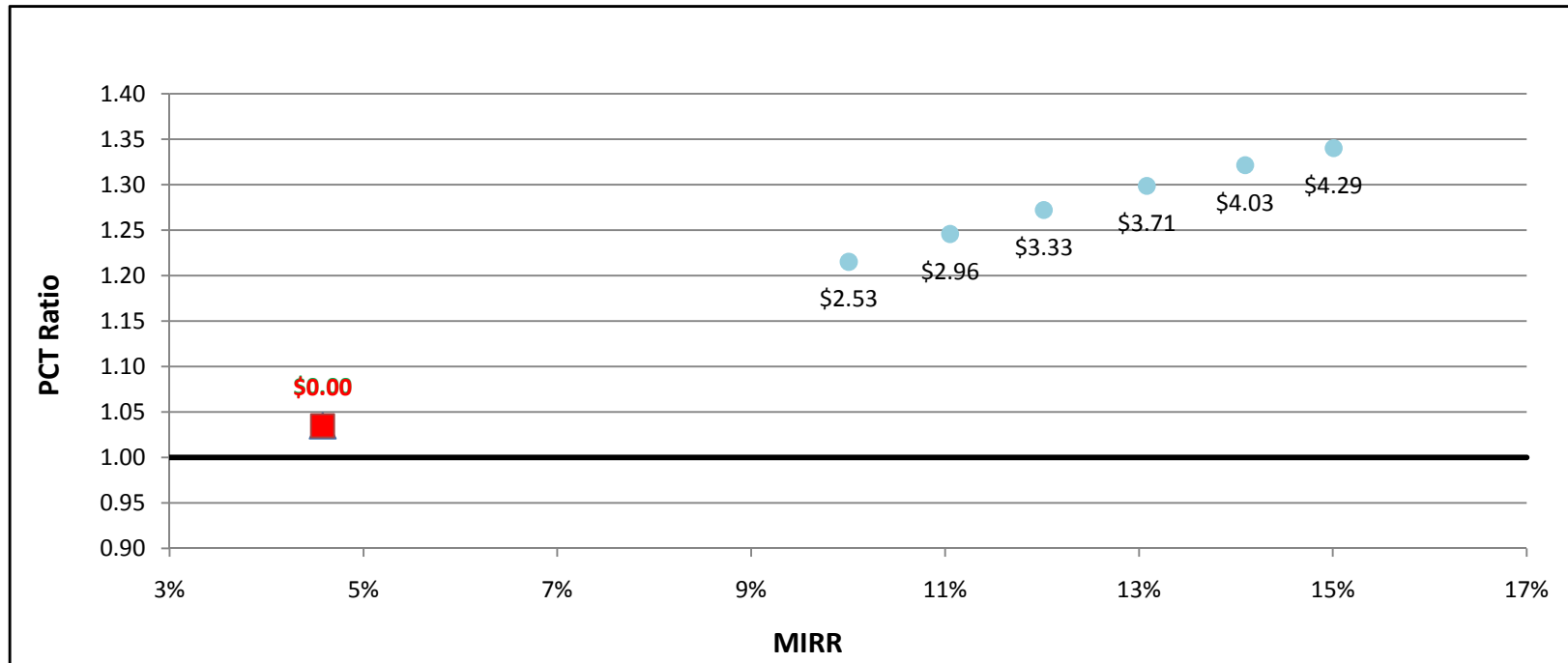

SGIP Cost Effectiveness Report
Participant Test Results (PCT)
MIRR Graphs

GTle2MW w/ Directed BioGas - Commercial - PG&E

	Rebate	MIRR	PCT-2010
▲ Actual Rebate - 2010	\$0.00	0.0%	0.81
■ No Rebate	\$0.00	0.0%	0.81
● Rebate to Reach MIRR of 10%	\$0.00	0.0%	0.00
● Rebate to Reach MIRR of 11%	\$0.00	0.0%	0.00
● Rebate to Reach MIRR of 12%	\$0.00	0.0%	0.00
● Rebate to Reach MIRR of 13%	\$0.00	0.0%	0.00
● Rebate to Reach MIRR of 14%	\$0.00	0.0%	0.00
● Rebate to Reach MIRR of 15%	\$0.00	0.0%	0.00

System Cost per Watt: \$4.20

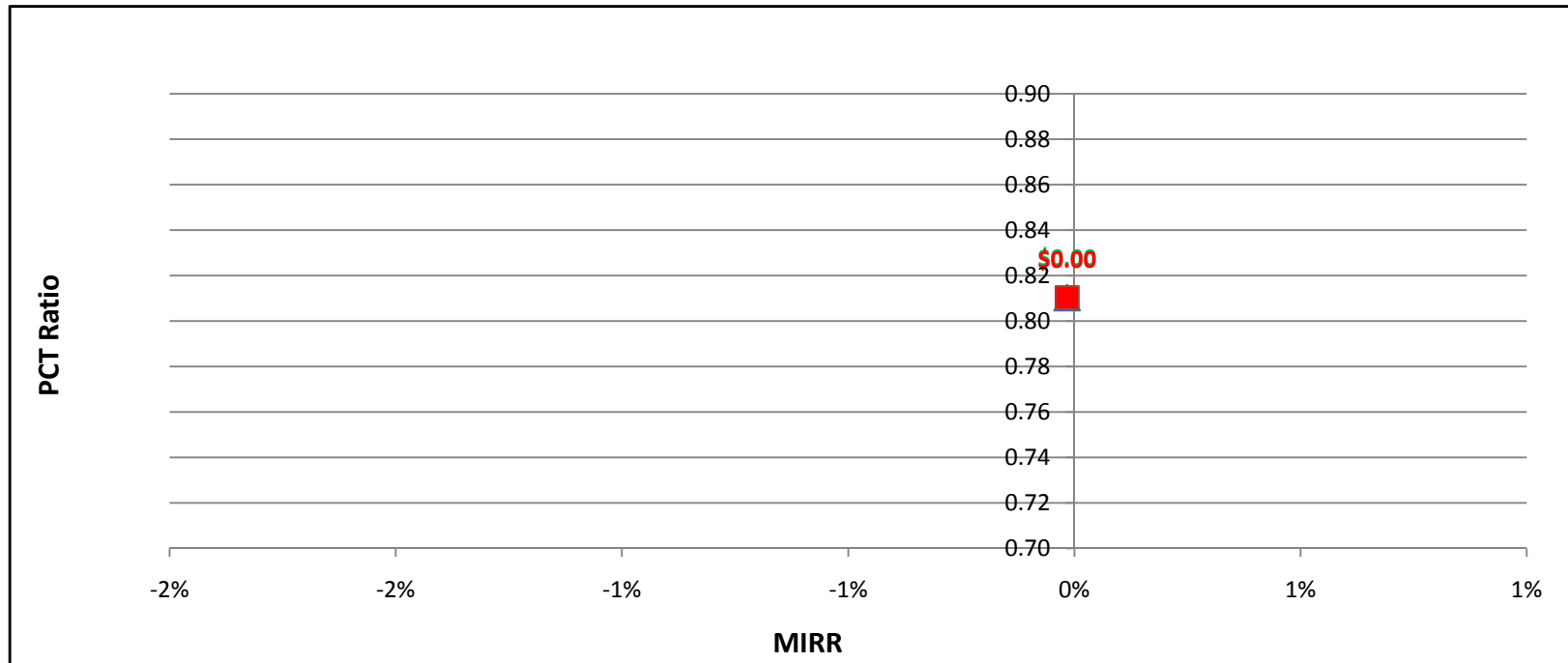

SGIP Cost Effectiveness Report
Participant Test Results (PCT)
MIRR Graphs

GTle2MW w/ Directed BioGas - Commercial - SCE

	Rebate	MIRR	PCT-2010
▲ Actual Rebate - 2010	\$0.00	-0.5%	0.80
■ No Rebate	\$0.00	-0.5%	0.80
● Rebate to Reach MIRR of 10%	\$0.00	0.0%	0.00
● Rebate to Reach MIRR of 11%	\$0.00	0.0%	0.00
● Rebate to Reach MIRR of 12%	\$0.00	0.0%	0.00
● Rebate to Reach MIRR of 13%	\$0.00	0.0%	0.00
● Rebate to Reach MIRR of 14%	\$0.00	0.0%	0.00
● Rebate to Reach MIRR of 15%	\$0.00	0.0%	0.00

System Cost per Watt: \$4.20

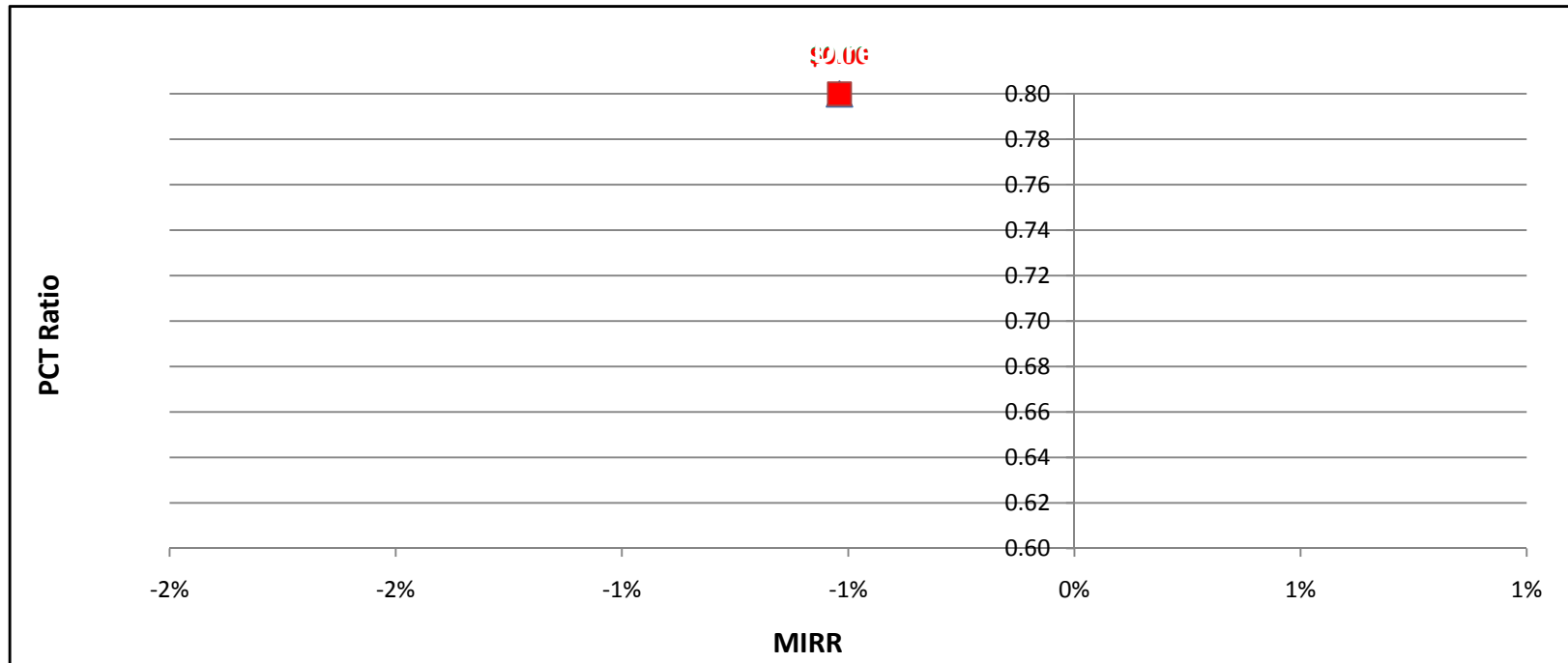

SGIP Cost Effectiveness Report
Participant Test Results (PCT)
MIRR Graphs

GTle2MW w/ Directed BioGas - Commercial - SDG&E

	Rebate	MIRR	PCT-2010
▲ Actual Rebate - 2010	\$0.00	-5.4%	0.71
■ No Rebate	\$0.00	-5.4%	0.71
● Rebate to Reach MIRR of 10%	\$0.00	0.0%	0.00
● Rebate to Reach MIRR of 11%	\$0.00	0.0%	0.00
● Rebate to Reach MIRR of 12%	\$0.00	0.0%	0.00
● Rebate to Reach MIRR of 13%	\$0.00	0.0%	0.00
● Rebate to Reach MIRR of 14%	\$0.00	0.0%	0.00
● Rebate to Reach MIRR of 15%	\$0.00	0.0%	0.00

System Cost per Watt: \$4.20

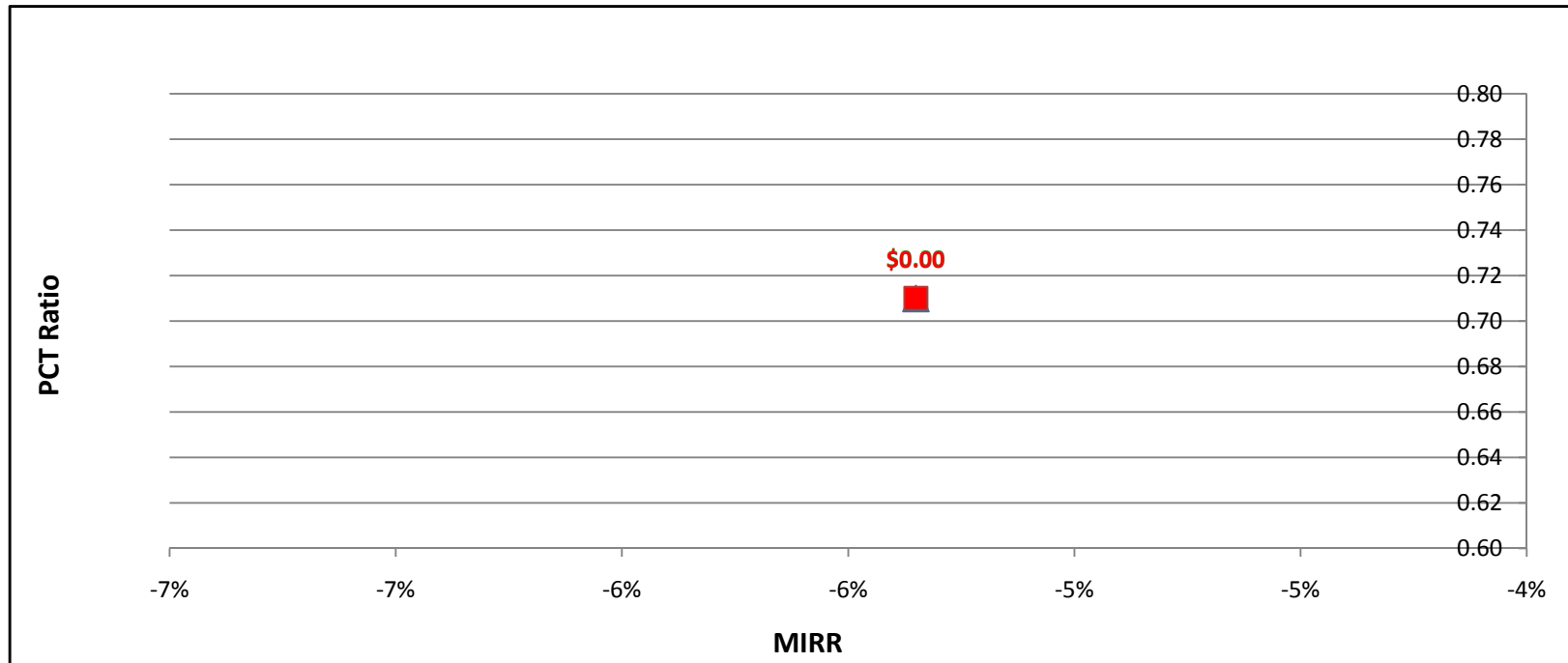

SGIP Cost Effectiveness Report
 Participant Test Results (PCT)
 MIRR Graphs

GTle2MW w/ Natural Gas - Commercial - PG&E

	Rebate	MIRR	PCT-2010
▲ Actual Rebate - 2010	\$0.00	6.3%	0.89
■ No Rebate	\$0.00	6.3%	0.89
● Rebate to Reach MIRR of 10%	\$2.12	10.0%	0.98
● Rebate to Reach MIRR of 11%	\$2.88	10.9%	1.02
● Rebate to Reach MIRR of 12%	\$3.91	12.0%	1.06
● Rebate to Reach MIRR of 13%	\$0.00	0.0%	0.00
● Rebate to Reach MIRR of 14%	\$0.00	0.0%	0.00
● Rebate to Reach MIRR of 15%	\$0.00	0.0%	0.00

System Cost per Watt: \$4.20

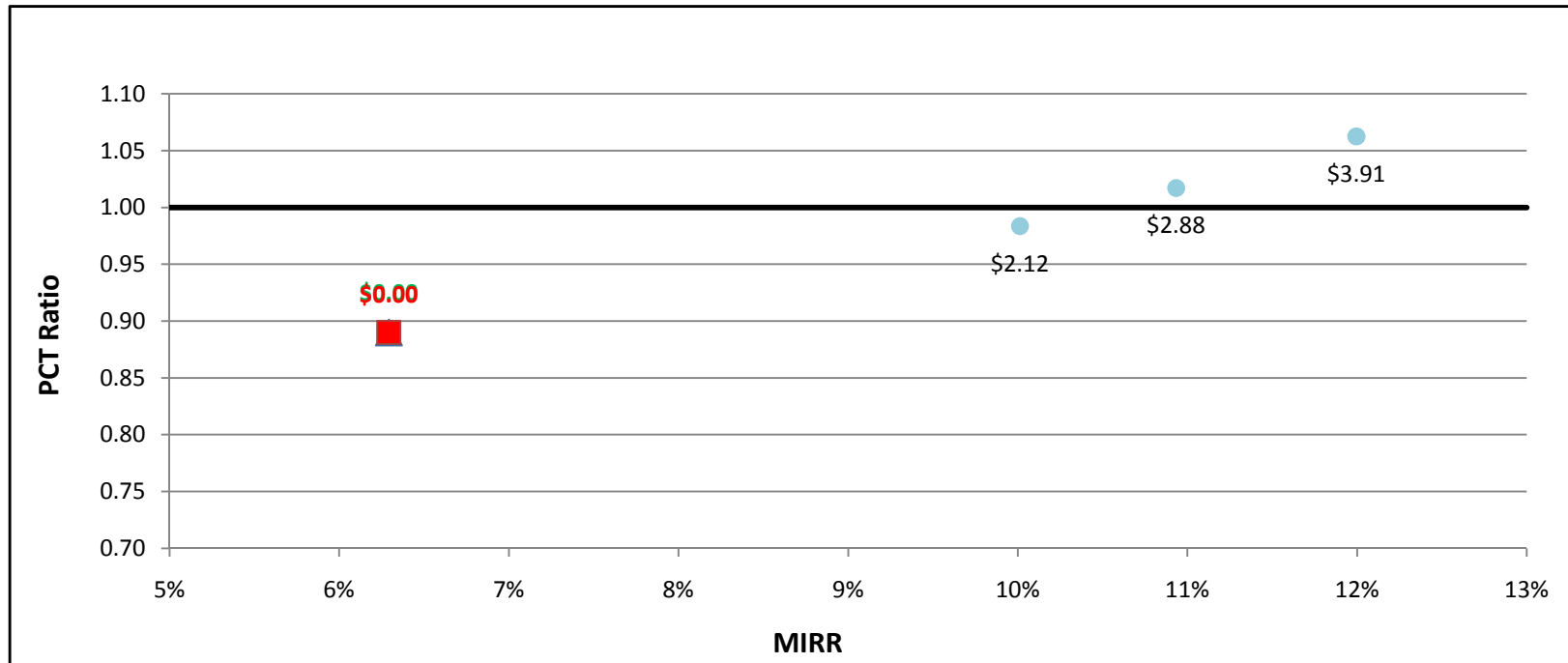

SGIP Cost Effectiveness Report
 Participant Test Results (PCT)
 MIRR Graphs

GTle2MW w/ Natural Gas - Commercial - SCE

	Rebate	MIRR	PCT-2010
▲ Actual Rebate - 2010	\$0.00	5.7%	0.88
■ No Rebate	\$0.00	5.7%	0.88
● Rebate to Reach MIRR of 10%	\$2.36	9.9%	0.98
● Rebate to Reach MIRR of 11%	\$3.25	11.0%	1.02
● Rebate to Reach MIRR of 12%	\$0.00	0.0%	0.00
● Rebate to Reach MIRR of 13%	\$0.00	0.0%	0.00
● Rebate to Reach MIRR of 14%	\$0.00	0.0%	0.00
● Rebate to Reach MIRR of 15%	\$0.00	0.0%	0.00

System Cost per Watt: \$4.20

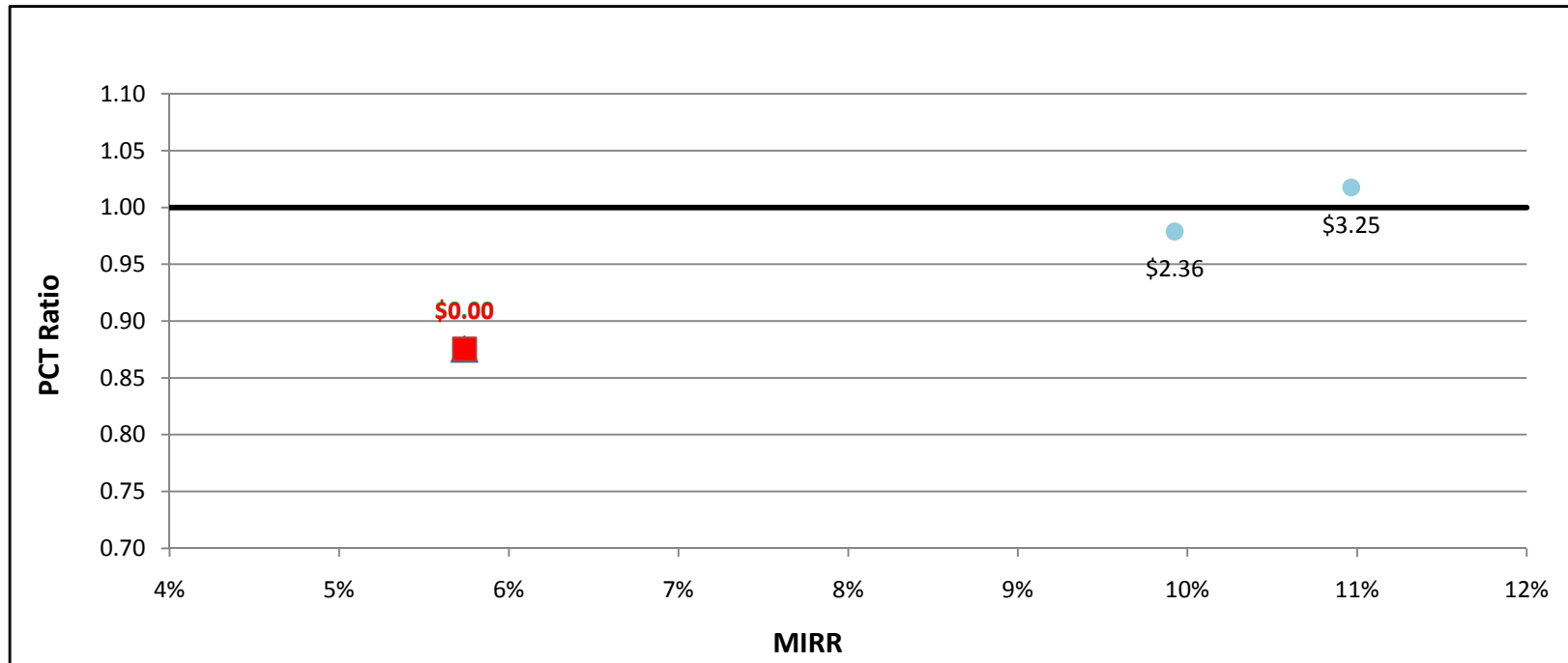

SGIP Cost Effectiveness Report
Participant Test Results (PCT)
MIRR Graphs

GTle2MW w/ Natural Gas - Commercial - SDG&E

	Rebate	MIRR	PCT-2010
▲ Actual Rebate - 2010	\$0.00	1.2%	0.75
■ No Rebate	\$0.00	1.2%	0.75
● Rebate to Reach MIRR of 10%	\$0.00	0.0%	0.00
● Rebate to Reach MIRR of 11%	\$0.00	0.0%	0.00
● Rebate to Reach MIRR of 12%	\$0.00	0.0%	0.00
● Rebate to Reach MIRR of 13%	\$0.00	0.0%	0.00
● Rebate to Reach MIRR of 14%	\$0.00	0.0%	0.00
● Rebate to Reach MIRR of 15%	\$0.00	0.0%	0.00

System Cost per Watt:	\$4.20
------------------------------	---------------

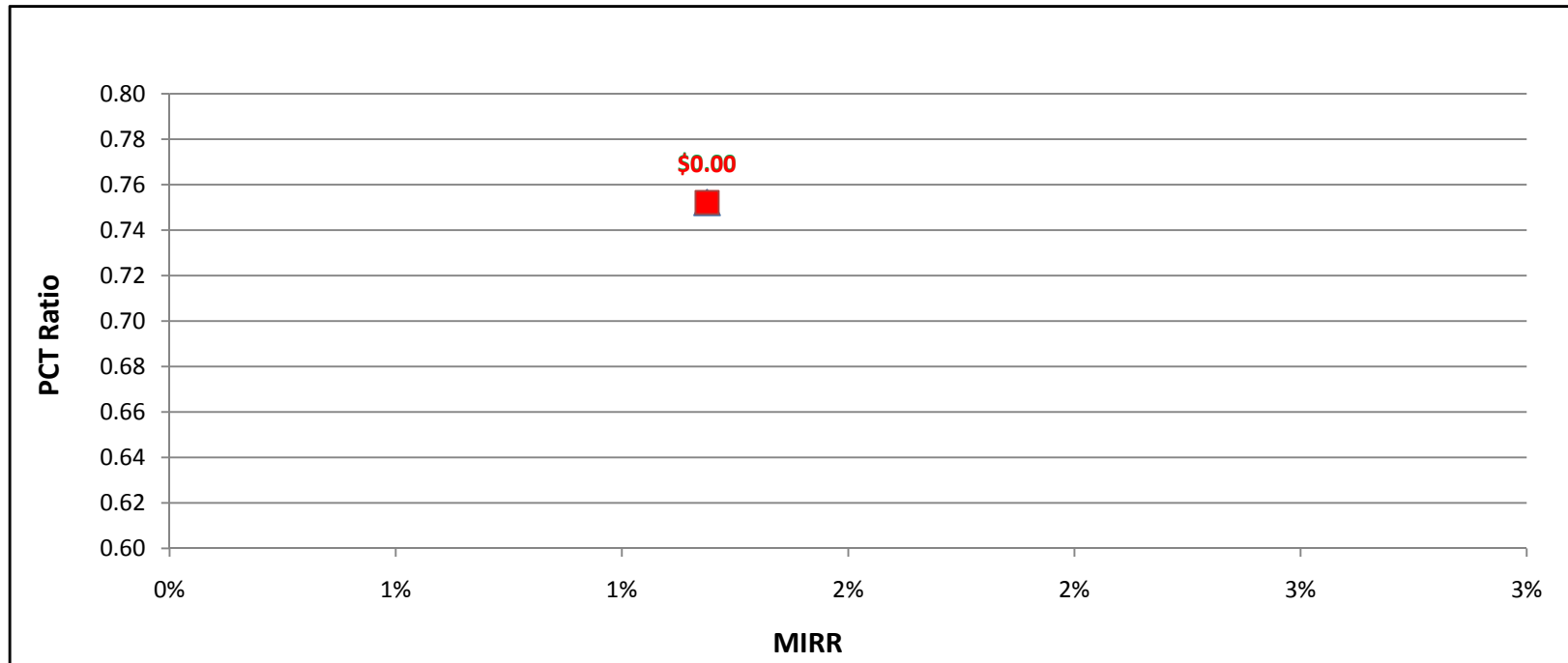

SGIP Cost Effectiveness Report
 Participant Test Results (PCT)
 MIRR Graphs

GTle2MW w/ On-Site BioGas - Commercial - PG&E

	Rebate	MIRR	PCT-2010
▲ Actual Rebate - 2010	\$0.00	10.9%	1.06
■ No Rebate	\$0.00	10.9%	1.06
● Rebate to Reach MIRR of 10%	\$0.00	0.0%	0.00
● Rebate to Reach MIRR of 11%	\$0.15	11.0%	1.07
● Rebate to Reach MIRR of 12%	\$1.28	11.9%	1.13
● Rebate to Reach MIRR of 13%	\$2.87	13.0%	1.21
● Rebate to Reach MIRR of 14%	\$0.00	0.0%	0.00
● Rebate to Reach MIRR of 15%	\$0.00	0.0%	0.00

System Cost per Watt: \$4.43

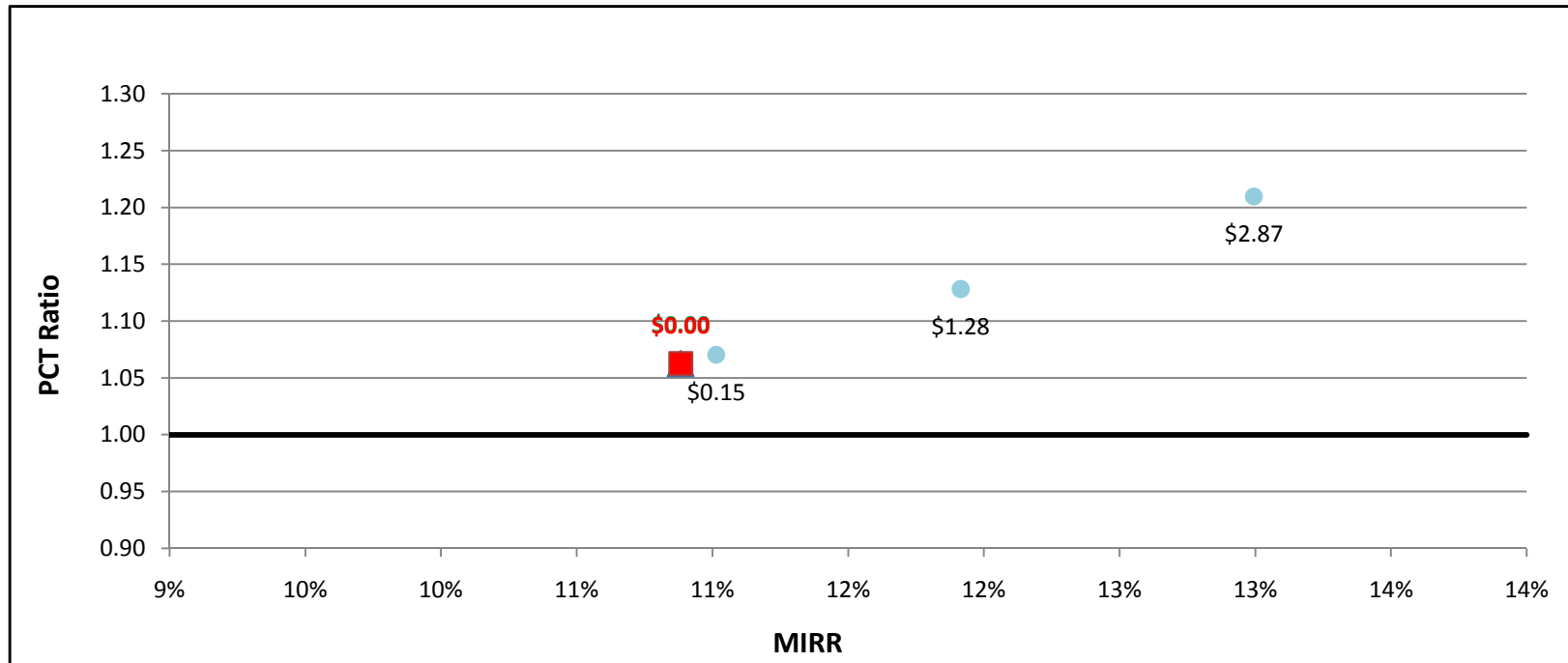

SGIP Cost Effectiveness Report
Participant Test Results (PCT)
MIRR Graphs

GTle2MW w/ On-Site BioGas - Commercial - SCE

	Rebate	MIRR	PCT-2010
▲ Actual Rebate - 2010	\$0.00	10.7%	1.05
■ No Rebate	\$0.00	10.7%	1.05
● Rebate to Reach MIRR of 10%	\$0.00	0.0%	0.00
● Rebate to Reach MIRR of 11%	\$0.37	11.0%	1.07
● Rebate to Reach MIRR of 12%	\$1.63	12.0%	1.13
● Rebate to Reach MIRR of 13%	\$3.05	13.0%	1.21
● Rebate to Reach MIRR of 14%	\$0.00	0.0%	0.00
● Rebate to Reach MIRR of 15%	\$0.00	0.0%	0.00

System Cost per Watt: \$4.43

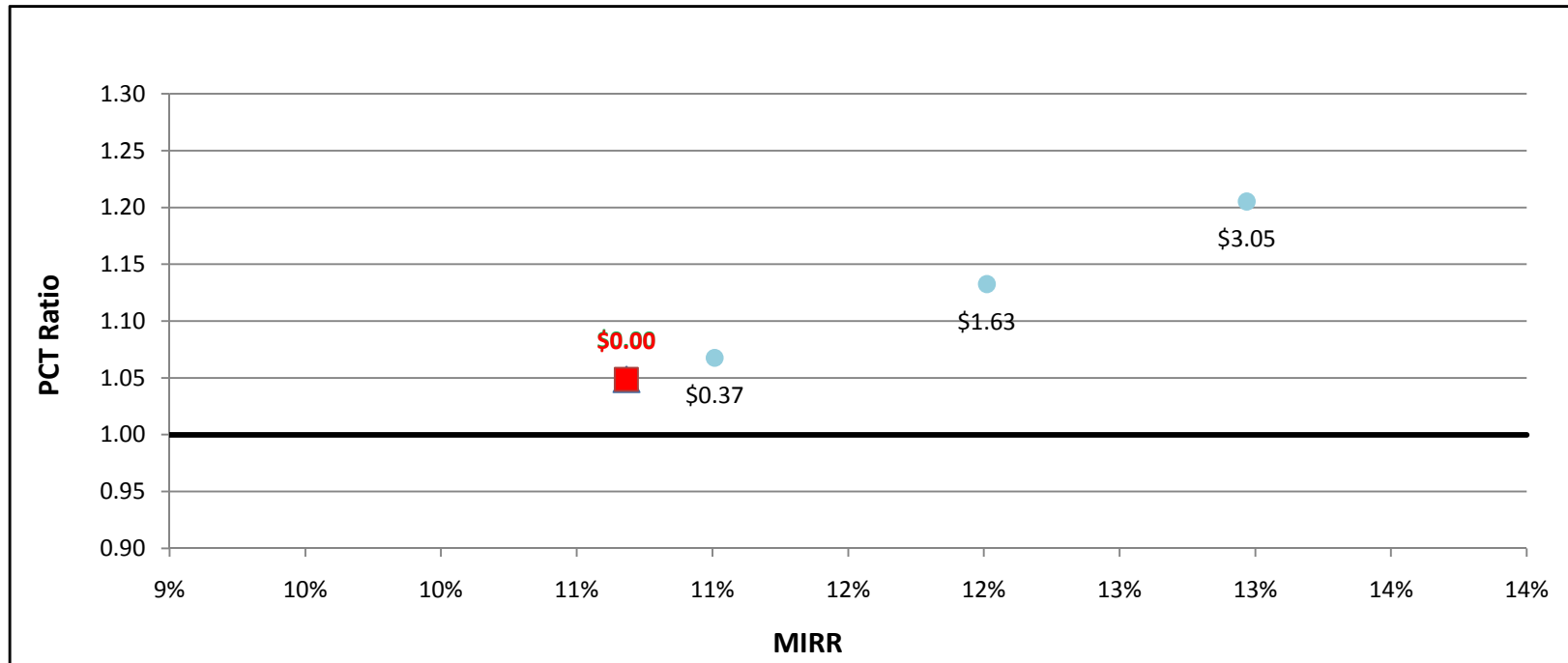

SGIP Cost Effectiveness Report
Participant Test Results (PCT)
MIRR Graphs

GTle2MW w/ On-Site BioGas - Commercial - SDG&E

	Rebate	MIRR	PCT-2010
▲ Actual Rebate - 2010	\$0.00	8.3%	0.91
■ No Rebate	\$0.00	8.3%	0.91
● Rebate to Reach MIRR of 10%	\$1.51	10.0%	0.99
● Rebate to Reach MIRR of 11%	\$2.51	11.0%	1.04
● Rebate to Reach MIRR of 12%	\$3.92	12.1%	1.11
● Rebate to Reach MIRR of 13%	\$0.00	0.0%	0.00
● Rebate to Reach MIRR of 14%	\$0.00	0.0%	0.00
● Rebate to Reach MIRR of 15%	\$0.00	0.0%	0.00

System Cost per Watt: \$4.43

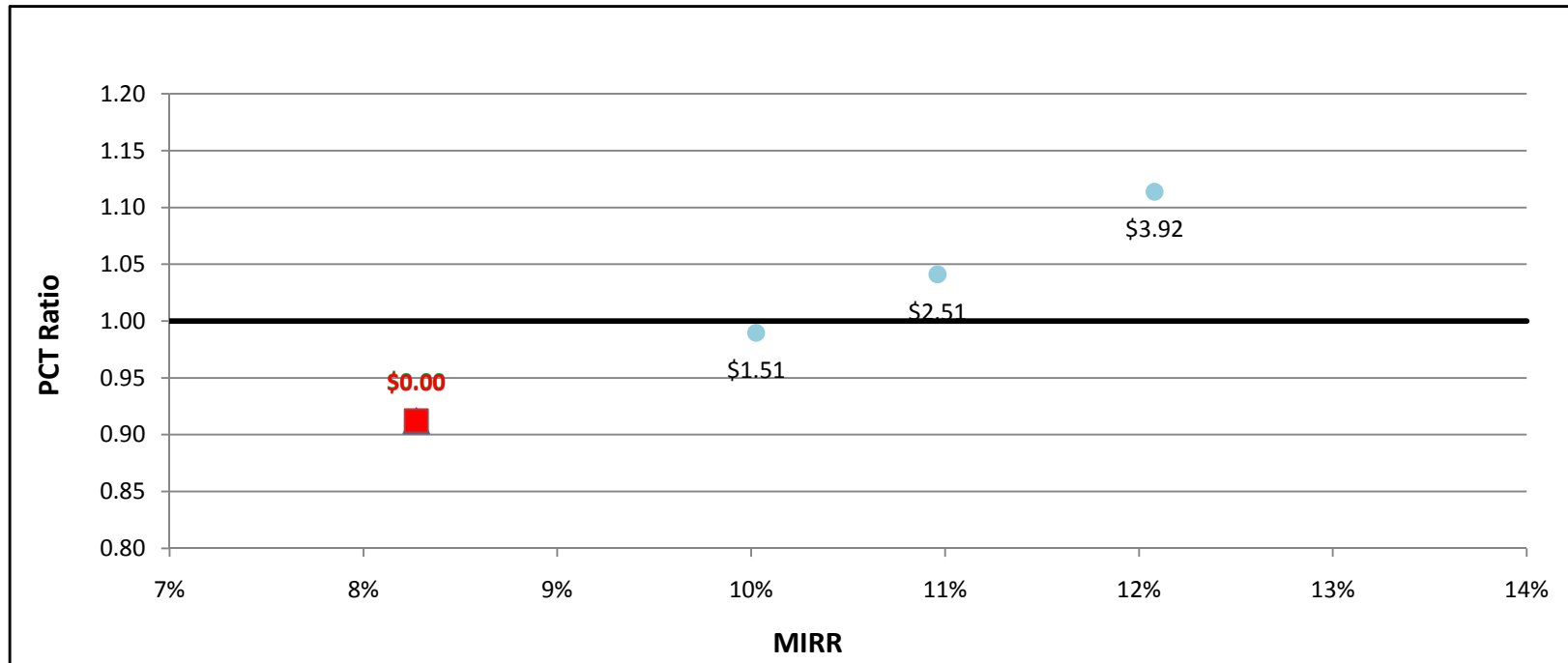

SGIP Cost Effectiveness Report
Participant Test Results (PCT)
MIRR Graphs

ICE1500kW w/ Directed BioGas - Government/Non-Profit - PG&E

	Rebate	MIRR	PCT-2010
▲ Actual Rebate - 2010	\$0.00	14.5%	1.23
■ No Rebate	\$0.00	14.5%	1.23
● Rebate to Reach MIRR of 10%	\$0.00	0.0%	0.00
● Rebate to Reach MIRR of 11%	\$0.00	0.0%	0.00
● Rebate to Reach MIRR of 12%	\$0.00	0.0%	0.00
● Rebate to Reach MIRR of 13%	\$0.00	0.0%	0.00
● Rebate to Reach MIRR of 14%	\$0.00	0.0%	0.00
● Rebate to Reach MIRR of 15%	\$0.12	15.0%	1.24

System Cost per Watt: \$1.81

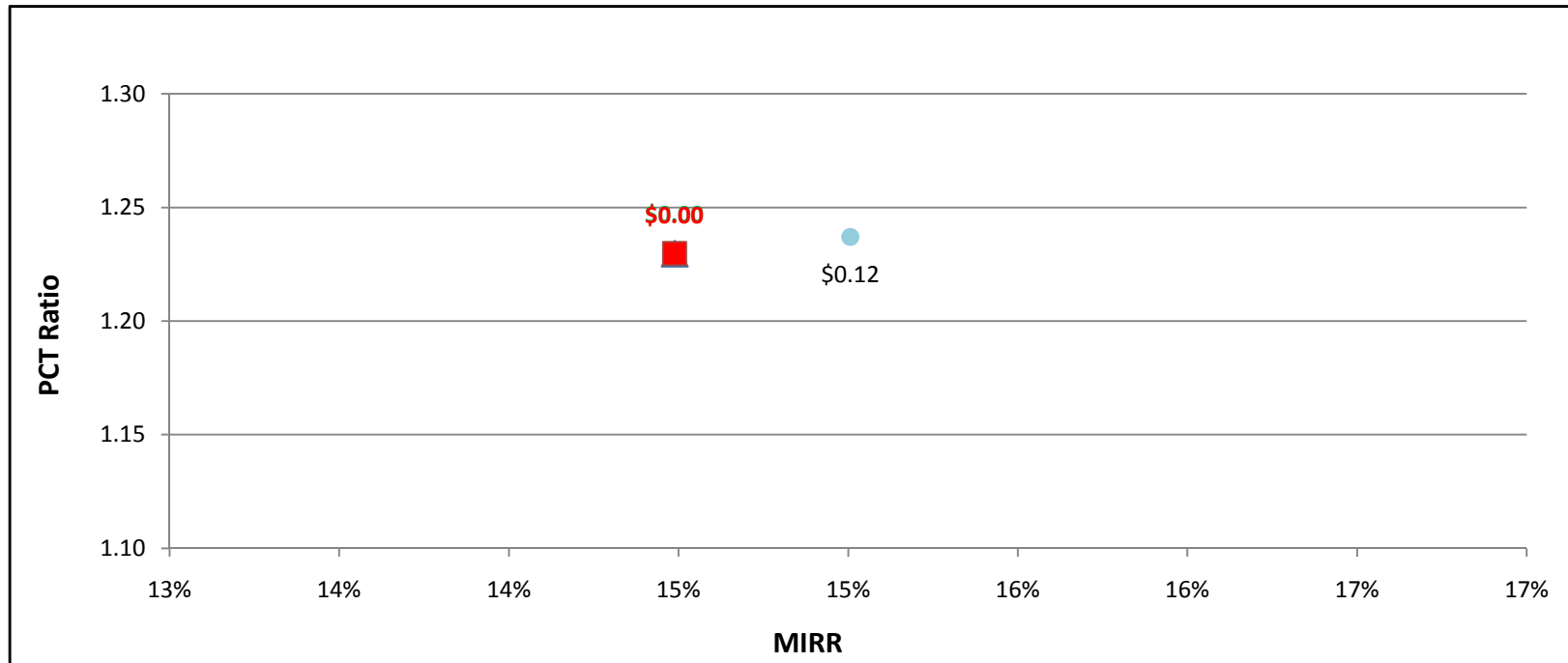

SGIP Cost Effectiveness Report
Participant Test Results (PCT)
MIRR Graphs

ICE1500kW w/ Directed BioGas - Government/Non-Profit - SCE

	Rebate	MIRR	PCT-2010
▲ Actual Rebate - 2010	\$0.00	14.5%	1.23
■ No Rebate	\$0.00	14.5%	1.23
● Rebate to Reach MIRR of 10%	\$0.00	0.0%	0.00
● Rebate to Reach MIRR of 11%	\$0.00	0.0%	0.00
● Rebate to Reach MIRR of 12%	\$0.00	0.0%	0.00
● Rebate to Reach MIRR of 13%	\$0.00	0.0%	0.00
● Rebate to Reach MIRR of 14%	\$0.00	0.0%	0.00
● Rebate to Reach MIRR of 15%	\$0.11	15.0%	1.24

System Cost per Watt: \$1.81

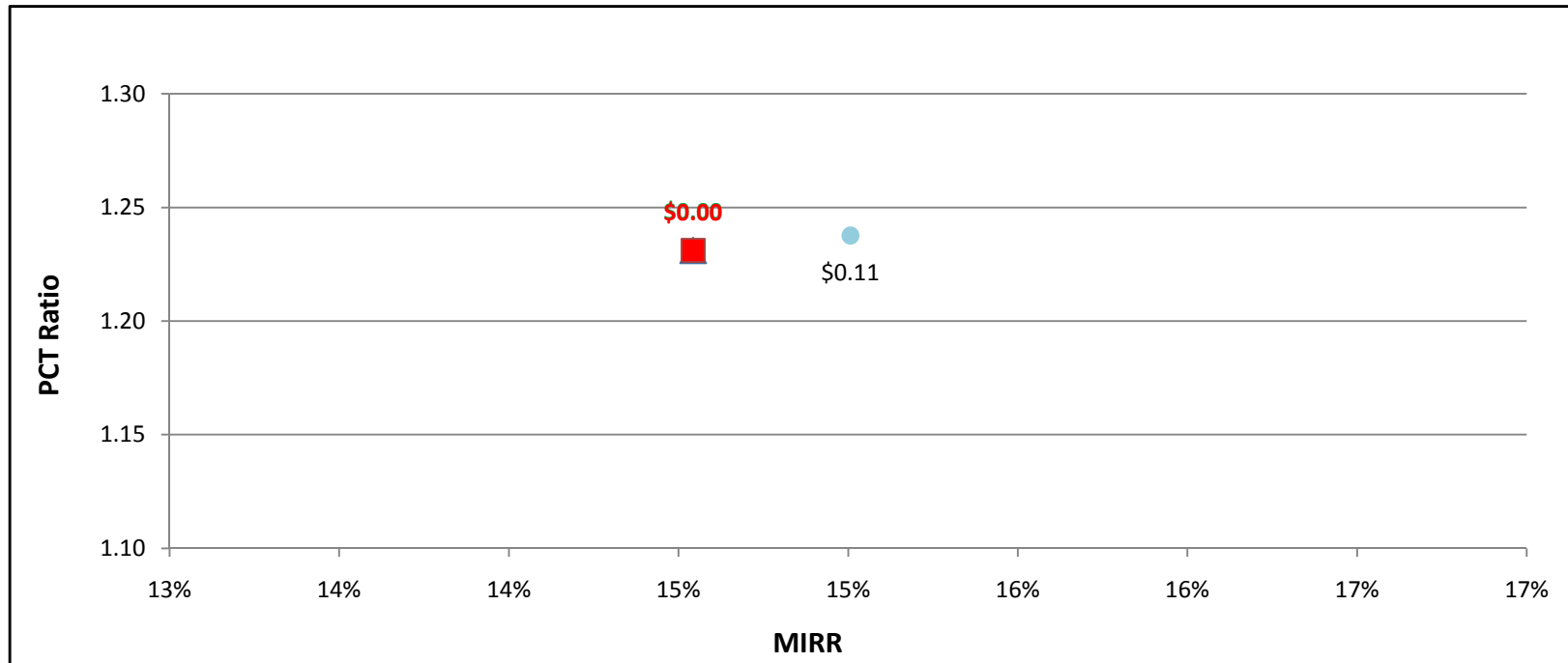

SGIP Cost Effectiveness Report
 Participant Test Results (PCT)
 MIRR Graphs

ICE1500kW w/ Directed BioGas - Government/Non-Profit - SDG&E

	Rebate	MIRR	PCT-2010
▲ Actual Rebate - 2010	\$0.00	2.0%	0.98
■ No Rebate	\$0.00	2.0%	0.98
● Rebate to Reach MIRR of 10%	\$1.08	10.0%	1.05
● Rebate to Reach MIRR of 11%	\$1.17	11.0%	1.05
● Rebate to Reach MIRR of 12%	\$1.26	12.0%	1.06
● Rebate to Reach MIRR of 13%	\$1.33	13.0%	1.06
● Rebate to Reach MIRR of 14%	\$1.40	14.1%	1.06
● Rebate to Reach MIRR of 15%	\$1.46	15.1%	1.07

System Cost per Watt: \$1.81

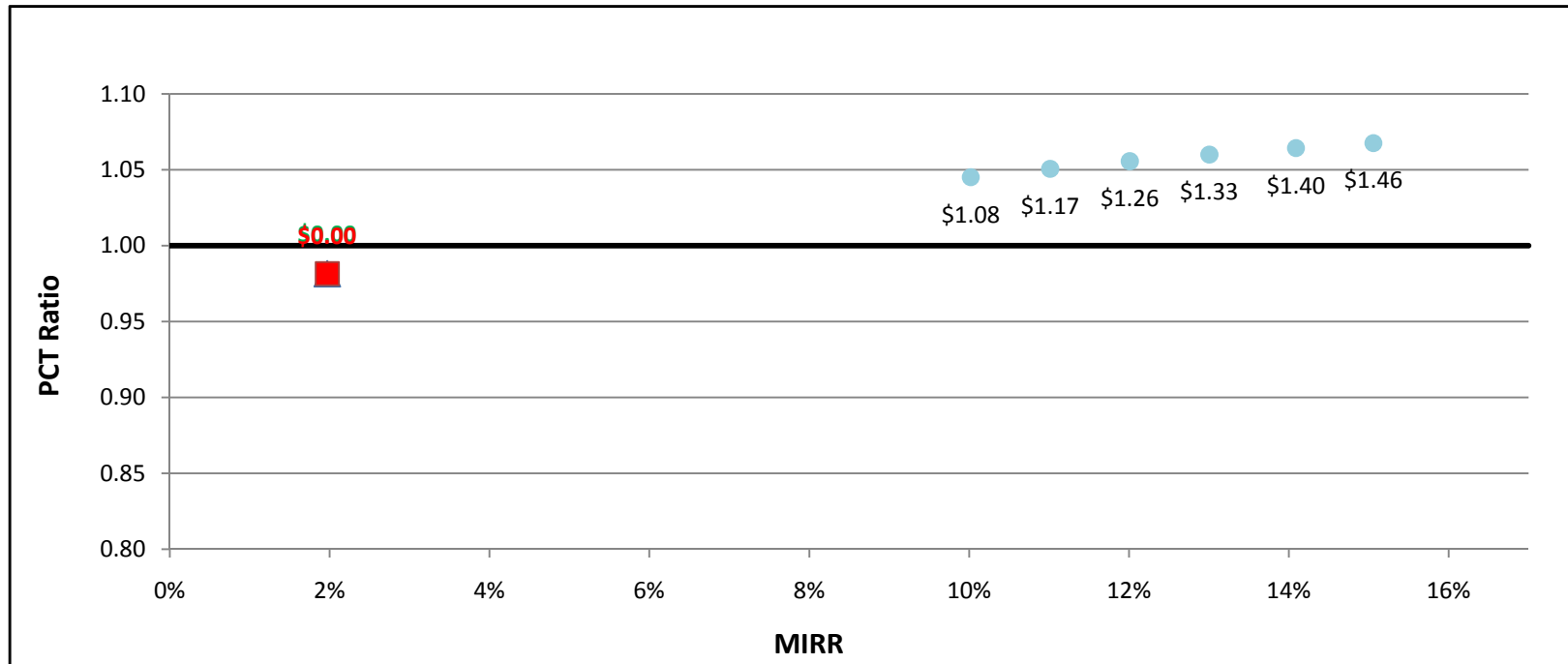

SGIP Cost Effectiveness Report
Participant Test Results (PCT)
MIRR Graphs

ICE1500kW w/ Natural Gas - Government/Non-Profit - PG&E

	Rebate	MIRR	PCT-2010
▲ Actual Rebate - 2010	\$0.00	17.7%	1.62
■ No Rebate	\$0.00	17.7%	1.62
● Rebate to Reach MIRR of 10%	\$0.00	0.0%	0.00
● Rebate to Reach MIRR of 11%	\$0.00	0.0%	0.00
● Rebate to Reach MIRR of 12%	\$0.00	0.0%	0.00
● Rebate to Reach MIRR of 13%	\$0.00	0.0%	0.00
● Rebate to Reach MIRR of 14%	\$0.00	0.0%	0.00
● Rebate to Reach MIRR of 15%	\$0.00	0.0%	0.00

System Cost per Watt: \$1.81

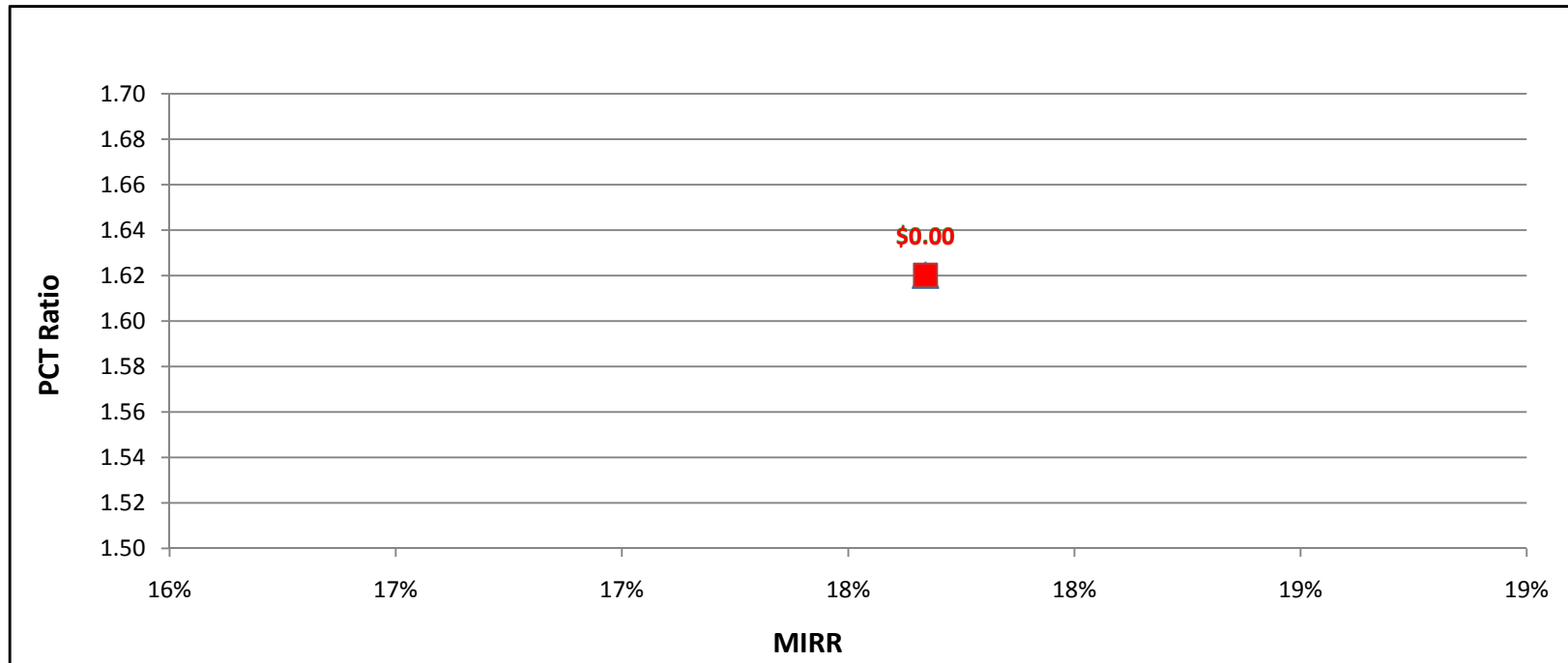

SGIP Cost Effectiveness Report
Participant Test Results (PCT)
MIRR Graphs

ICE1500kW w/ Natural Gas - Government/Non-Profit - SCE

	Rebate	MIRR	PCT-2010
▲ Actual Rebate - 2010	\$0.00	17.7%	1.62
■ No Rebate	\$0.00	17.7%	1.62
● Rebate to Reach MIRR of 10%	\$0.00	0.0%	0.00
● Rebate to Reach MIRR of 11%	\$0.00	0.0%	0.00
● Rebate to Reach MIRR of 12%	\$0.00	0.0%	0.00
● Rebate to Reach MIRR of 13%	\$0.00	0.0%	0.00
● Rebate to Reach MIRR of 14%	\$0.00	0.0%	0.00
● Rebate to Reach MIRR of 15%	\$0.00	0.0%	0.00

System Cost per Watt: \$1.81

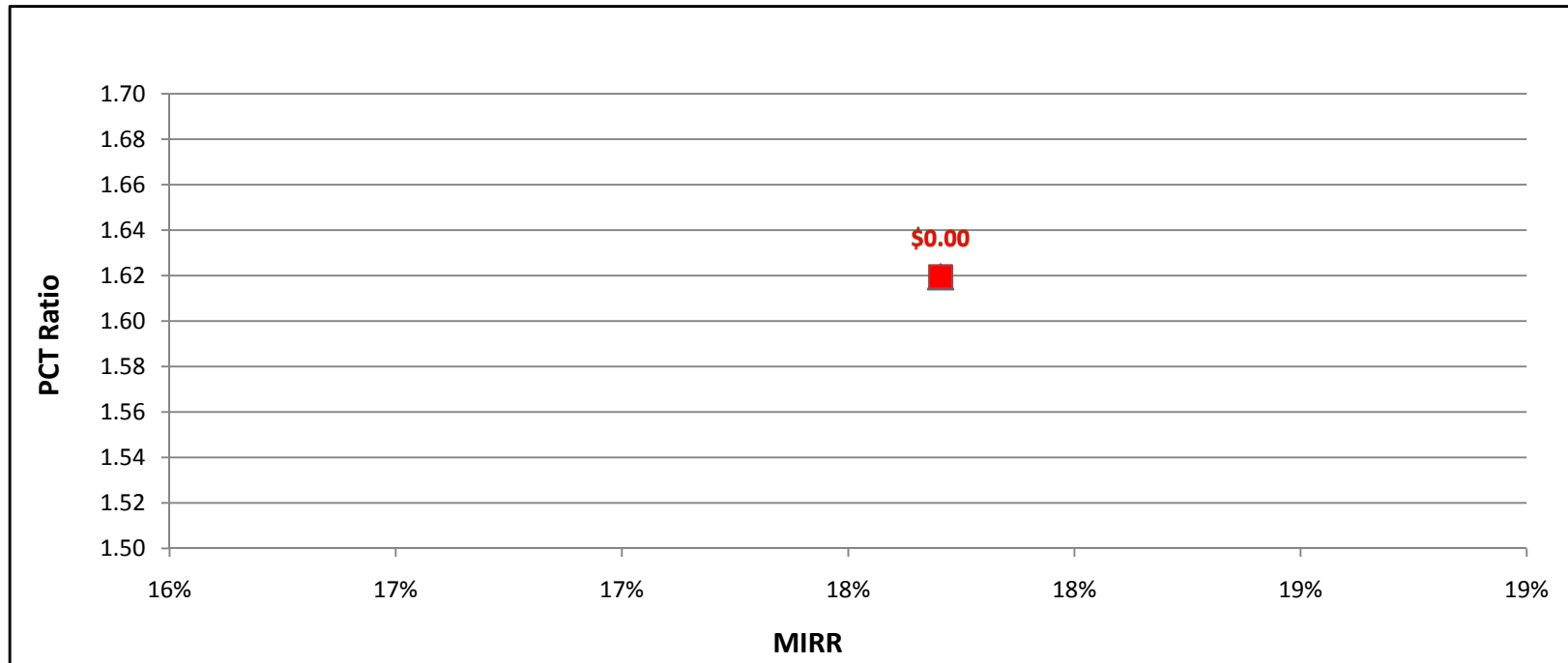

SGIP Cost Effectiveness Report
Participant Test Results (PCT)
MIRR Graphs

ICE1500kW w/ Natural Gas - Government/Non-Profit - SDG&E

	Rebate	MIRR	PCT-2010
▲ Actual Rebate - 2010	\$0.00	12.9%	1.24
■ No Rebate	\$0.00	12.9%	1.24
● Rebate to Reach MIRR of 10%	\$0.00	0.0%	0.00
● Rebate to Reach MIRR of 11%	\$0.00	0.0%	0.00
● Rebate to Reach MIRR of 12%	\$0.00	0.0%	0.00
● Rebate to Reach MIRR of 13%	\$0.01	13.0%	1.24
● Rebate to Reach MIRR of 14%	\$0.23	14.0%	1.26
● Rebate to Reach MIRR of 15%	\$0.44	15.1%	1.28

System Cost per Watt: \$1.81

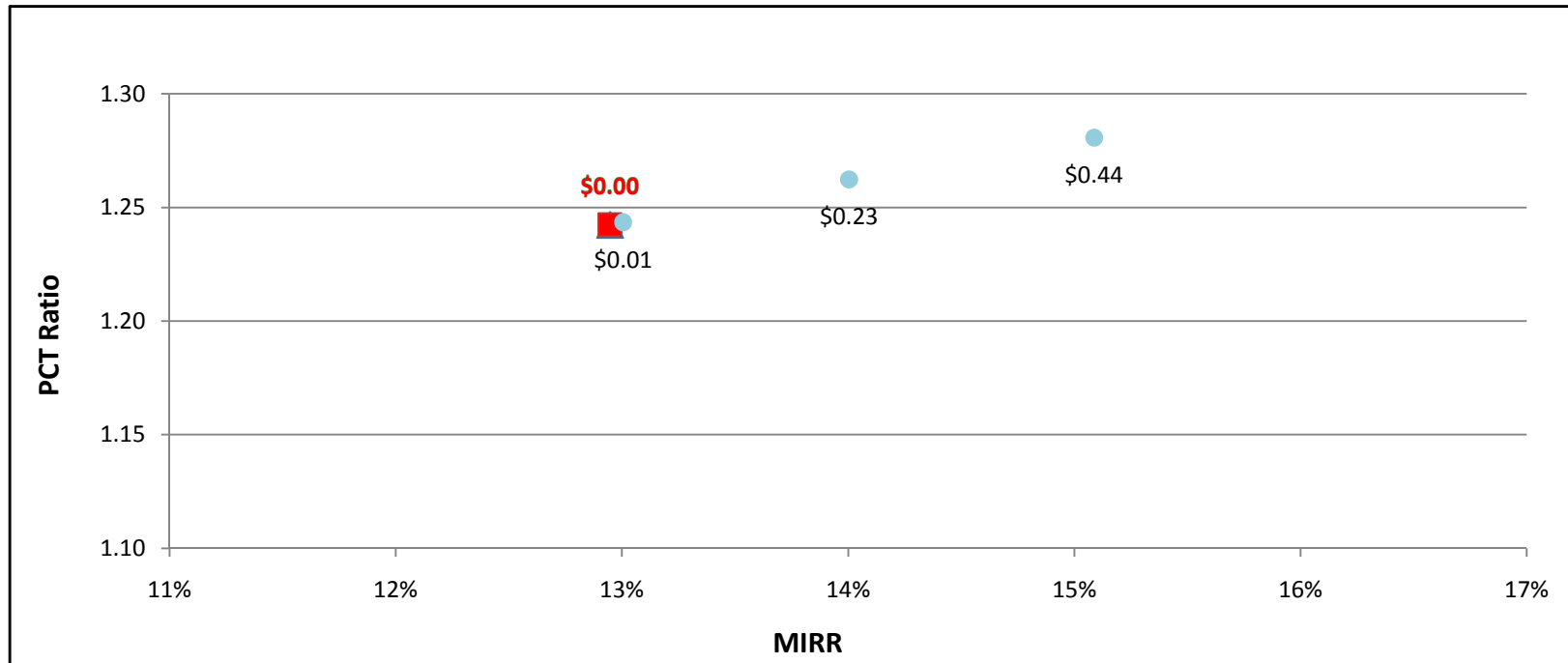

SGIP Cost Effectiveness Report
Participant Test Results (PCT)
MIRR Graphs

ICE1500kW w/ On-Site BioGas - Government/Non-Profit - PG&E

	Rebate	MIRR	PCT-2010
▲ Actual Rebate - 2010	\$0.00	19.0%	2.97
■ No Rebate	\$0.00	19.0%	2.97
● Rebate to Reach MIRR of 10%	\$0.00	0.0%	0.00
● Rebate to Reach MIRR of 11%	\$0.00	0.0%	0.00
● Rebate to Reach MIRR of 12%	\$0.00	0.0%	0.00
● Rebate to Reach MIRR of 13%	\$0.00	0.0%	0.00
● Rebate to Reach MIRR of 14%	\$0.00	0.0%	0.00
● Rebate to Reach MIRR of 15%	\$0.00	0.0%	0.00

System Cost per Watt: \$1.96

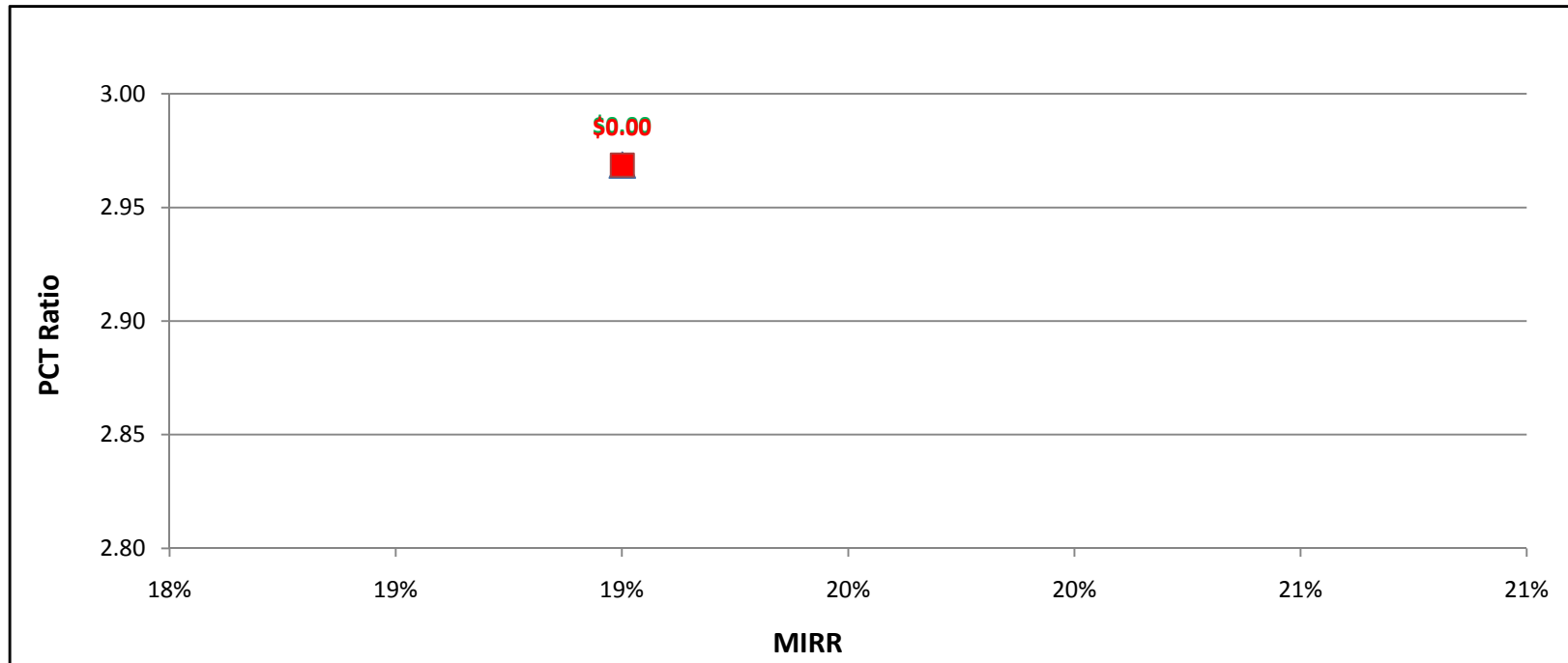

SGIP Cost Effectiveness Report
Participant Test Results (PCT)
MIRR Graphs

ICE1500kW w/ On-Site BioGas - Government/Non-Profit - SCE

	Rebate	MIRR	PCT-2010
▲ Actual Rebate - 2010	\$0.00	19.1%	2.99
■ No Rebate	\$0.00	19.1%	2.99
● Rebate to Reach MIRR of 10%	\$0.00	0.0%	0.00
● Rebate to Reach MIRR of 11%	\$0.00	0.0%	0.00
● Rebate to Reach MIRR of 12%	\$0.00	0.0%	0.00
● Rebate to Reach MIRR of 13%	\$0.00	0.0%	0.00
● Rebate to Reach MIRR of 14%	\$0.00	0.0%	0.00
● Rebate to Reach MIRR of 15%	\$0.00	0.0%	0.00

System Cost per Watt: \$1.96

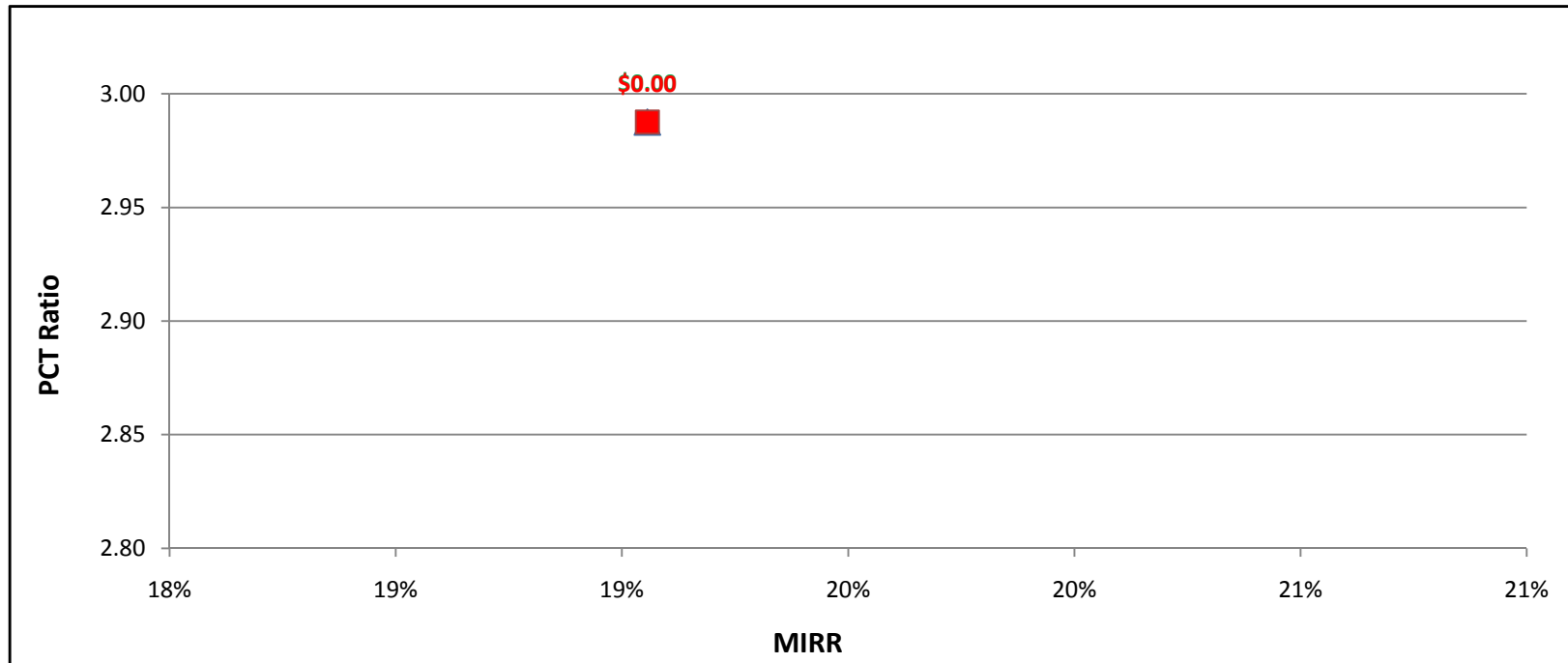

SGIP Cost Effectiveness Report
Participant Test Results (PCT)
MIRR Graphs

ICE1500kW w/ On-Site BioGas - Government/Non-Profit - SDG&E

	Rebate	MIRR	PCT-2010
▲ Actual Rebate - 2010	\$0.00	17.2%	2.42
■ No Rebate	\$0.00	17.2%	2.42
● Rebate to Reach MIRR of 10%	\$0.00	0.0%	0.00
● Rebate to Reach MIRR of 11%	\$0.00	0.0%	0.00
● Rebate to Reach MIRR of 12%	\$0.00	0.0%	0.00
● Rebate to Reach MIRR of 13%	\$0.00	0.0%	0.00
● Rebate to Reach MIRR of 14%	\$0.00	0.0%	0.00
● Rebate to Reach MIRR of 15%	\$0.00	0.0%	0.00

System Cost per Watt: \$1.96

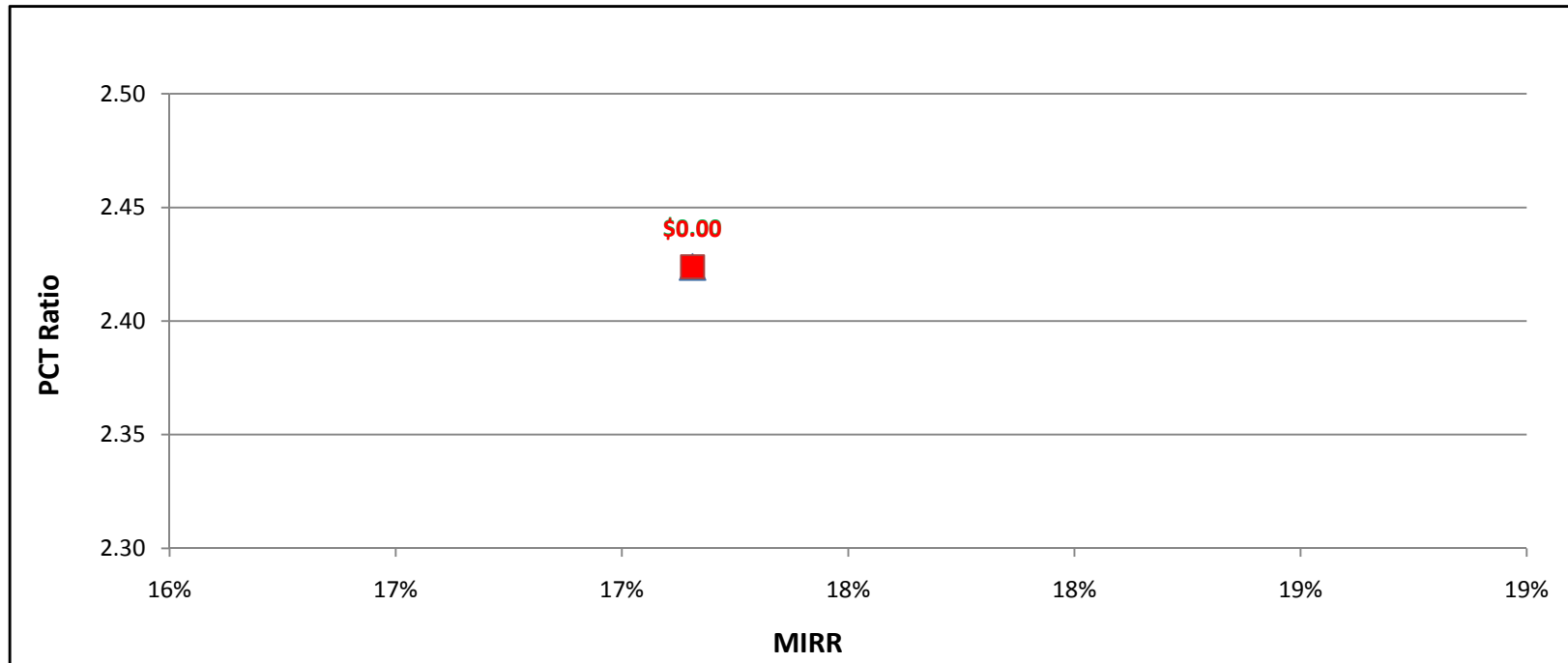

SGIP Cost Effectiveness Report
Participant Test Results (PCT)
MIRR Graphs

ICE1500kW w/ Directed BioGas - Commercial - PG&E

	Rebate	MIRR	PCT-2010
▲ Actual Rebate - 2010	\$0.00	12.6%	1.05
■ No Rebate	\$0.00	12.6%	1.05
● Rebate to Reach MIRR of 10%	\$0.00	0.0%	0.00
● Rebate to Reach MIRR of 11%	\$0.00	0.0%	0.00
● Rebate to Reach MIRR of 12%	\$0.00	0.0%	0.00
● Rebate to Reach MIRR of 13%	\$0.20	13.0%	1.06
● Rebate to Reach MIRR of 14%	\$0.70	14.0%	1.09
● Rebate to Reach MIRR of 15%	\$1.26	15.0%	1.12

System Cost per Watt: \$1.81

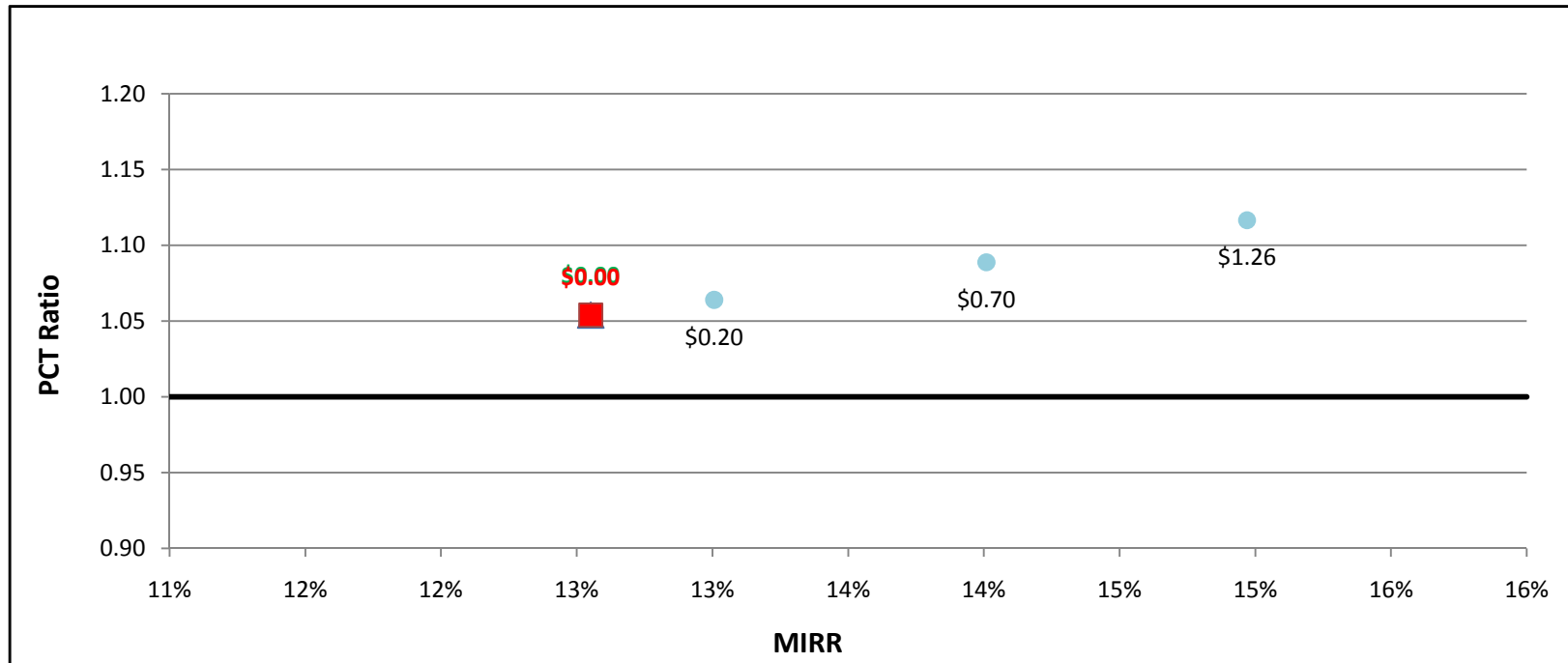

SGIP Cost Effectiveness Report
Participant Test Results (PCT)
MIRR Graphs

ICE1500kW w/ Directed BioGas - Commercial - SCE

	Rebate	MIRR	PCT-2010
▲ Actual Rebate - 2010	\$0.00	12.6%	1.06
■ No Rebate	\$0.00	12.6%	1.06
● Rebate to Reach MIRR of 10%	\$0.00	0.0%	0.00
● Rebate to Reach MIRR of 11%	\$0.00	0.0%	0.00
● Rebate to Reach MIRR of 12%	\$0.00	0.0%	0.00
● Rebate to Reach MIRR of 13%	\$0.16	13.0%	1.06
● Rebate to Reach MIRR of 14%	\$0.66	14.0%	1.09
● Rebate to Reach MIRR of 15%	\$1.24	15.0%	1.12

System Cost per Watt: \$1.81

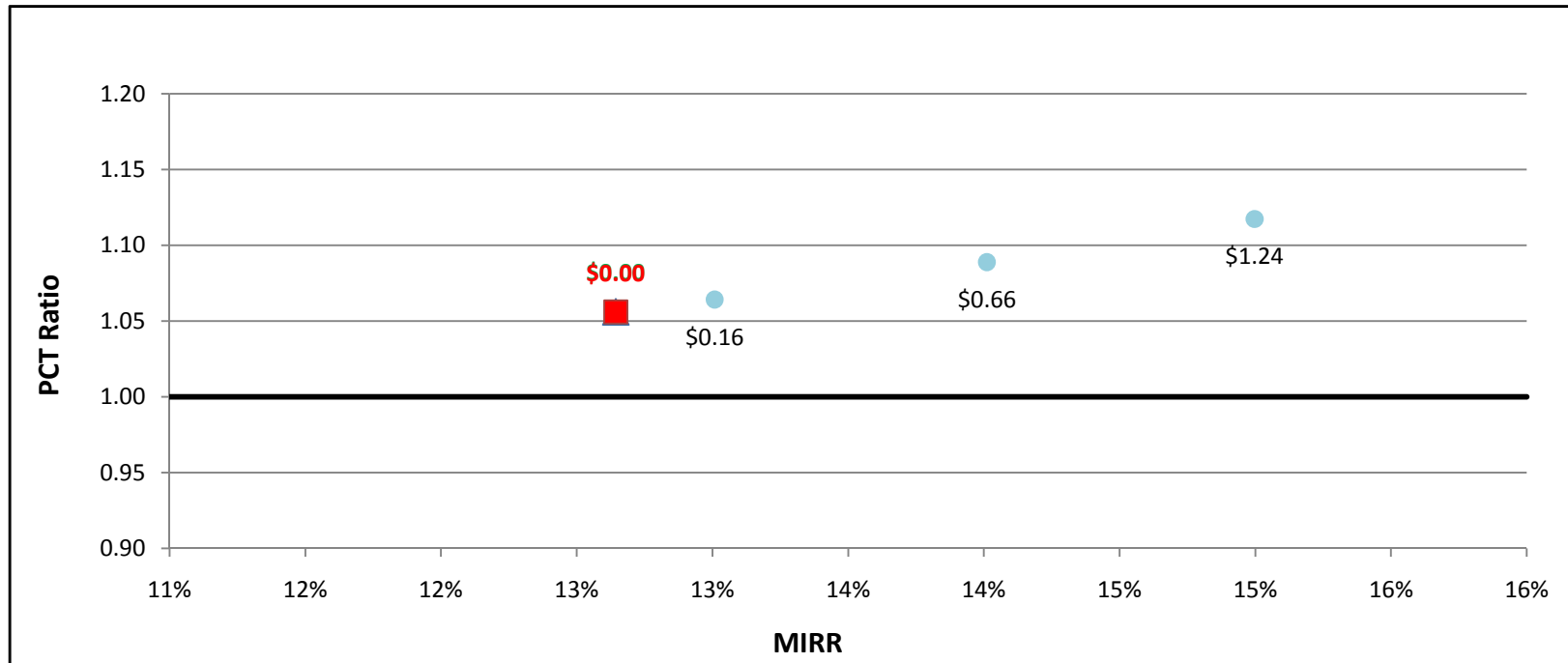

SGIP Cost Effectiveness Report
Participant Test Results (PCT)
MIRR Graphs

ICE1500kW w/ Directed BioGas - Commercial - SDG&E

	Rebate	MIRR	PCT-2010
▲ Actual Rebate - 2010	\$0.00	3.0%	0.92
■ No Rebate	\$0.00	3.0%	0.92
● Rebate to Reach MIRR of 10%	\$1.48	10.0%	0.99
● Rebate to Reach MIRR of 11%	\$0.00	0.0%	0.00
● Rebate to Reach MIRR of 12%	\$0.00	0.0%	0.00
● Rebate to Reach MIRR of 13%	\$0.00	0.0%	0.00
● Rebate to Reach MIRR of 14%	\$0.00	0.0%	0.00
● Rebate to Reach MIRR of 15%	\$0.00	0.0%	0.00

System Cost per Watt: \$1.81

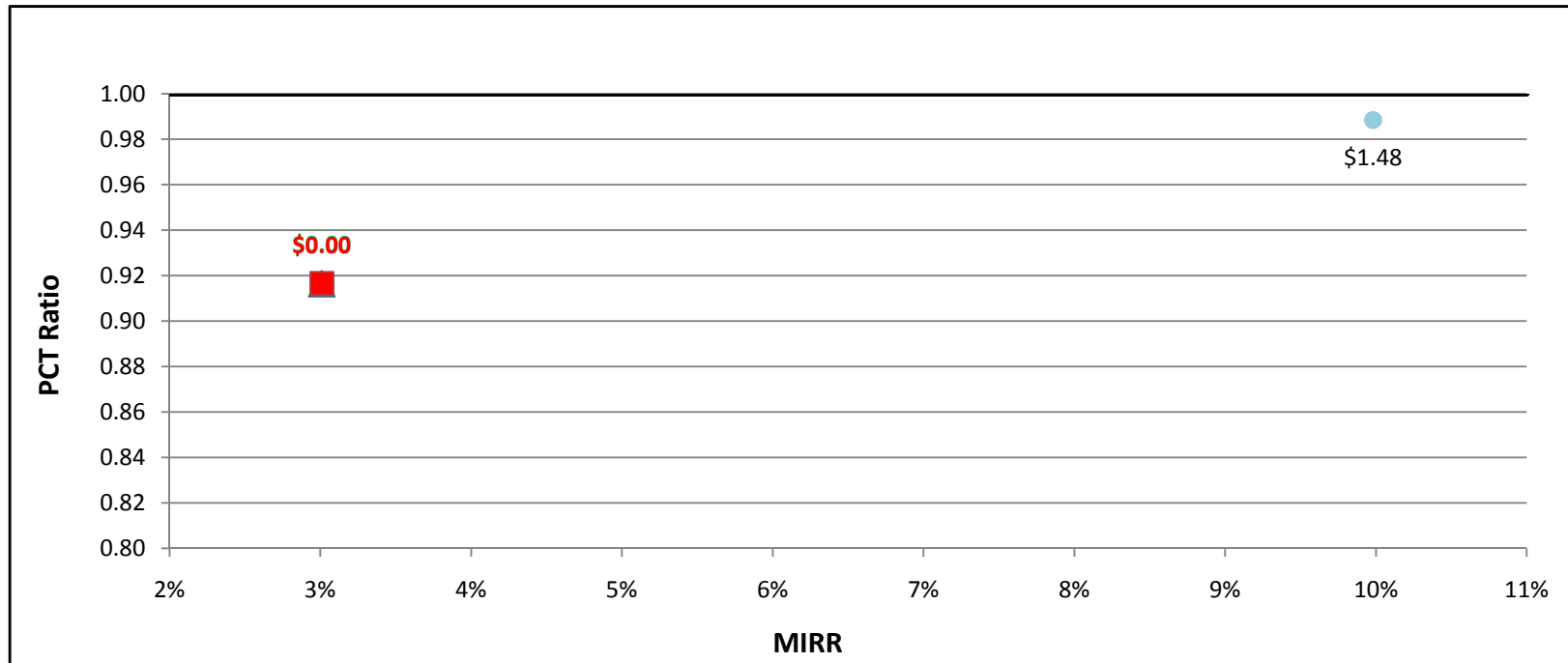

SGIP Cost Effectiveness Report
Participant Test Results (PCT)
MIRR Graphs

ICE1500kW w/ Natural Gas - Commercial - PG&E

	Rebate	MIRR	PCT-2010
▲ Actual Rebate - 2010	\$0.00	15.8%	1.24
■ No Rebate	\$0.00	15.8%	1.24
● Rebate to Reach MIRR of 10%	\$0.00	0.0%	0.00
● Rebate to Reach MIRR of 11%	\$0.00	0.0%	0.00
● Rebate to Reach MIRR of 12%	\$0.00	0.0%	0.00
● Rebate to Reach MIRR of 13%	\$0.00	0.0%	0.00
● Rebate to Reach MIRR of 14%	\$0.00	0.0%	0.00
● Rebate to Reach MIRR of 15%	\$0.00	0.0%	0.00

System Cost per Watt: \$1.81

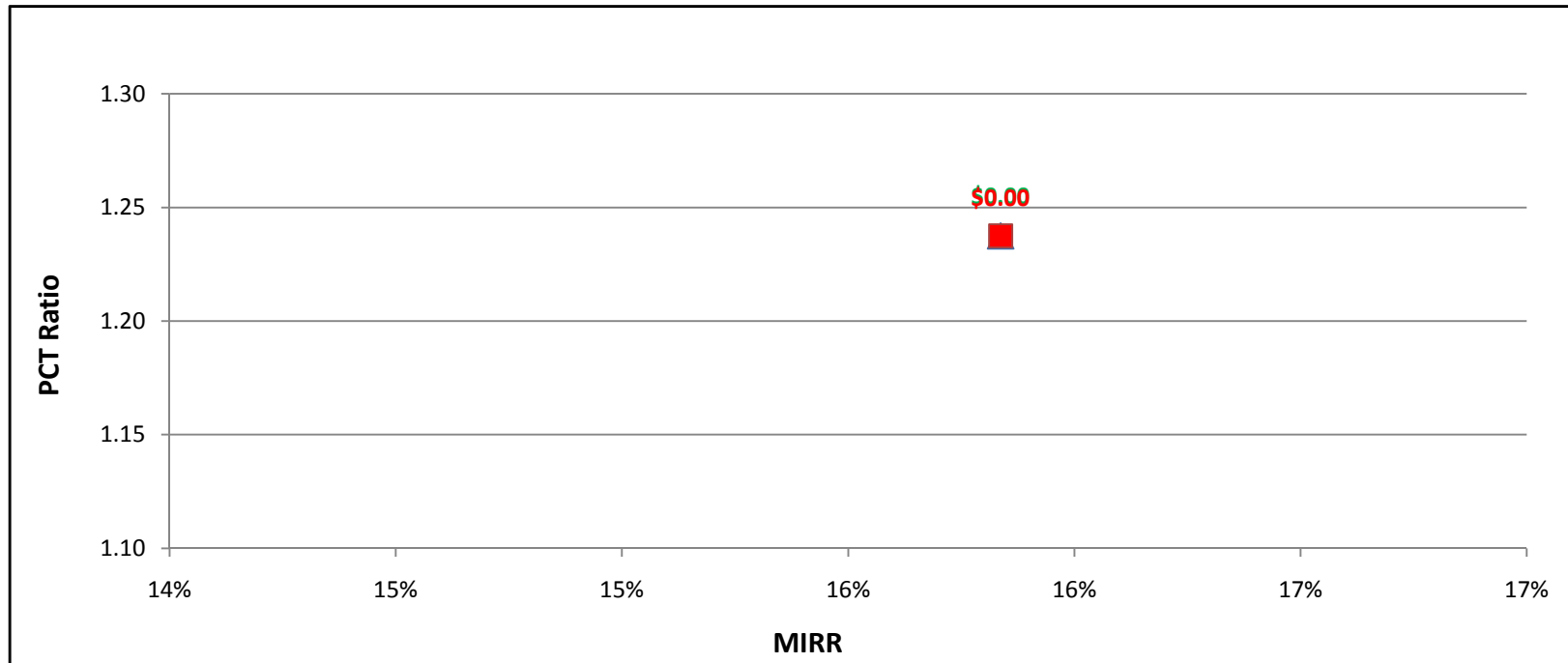

SGIP Cost Effectiveness Report
Participant Test Results (PCT)
MIRR Graphs

ICE1500kW w/ Natural Gas - Commercial - SCE

	Rebate	MIRR	PCT-2010
▲ Actual Rebate - 2010	\$0.00	15.9%	1.24
■ No Rebate	\$0.00	15.9%	1.24
● Rebate to Reach MIRR of 10%	\$0.00	0.0%	0.00
● Rebate to Reach MIRR of 11%	\$0.00	0.0%	0.00
● Rebate to Reach MIRR of 12%	\$0.00	0.0%	0.00
● Rebate to Reach MIRR of 13%	\$0.00	0.0%	0.00
● Rebate to Reach MIRR of 14%	\$0.00	0.0%	0.00
● Rebate to Reach MIRR of 15%	\$0.00	0.0%	0.00

System Cost per Watt: \$1.81

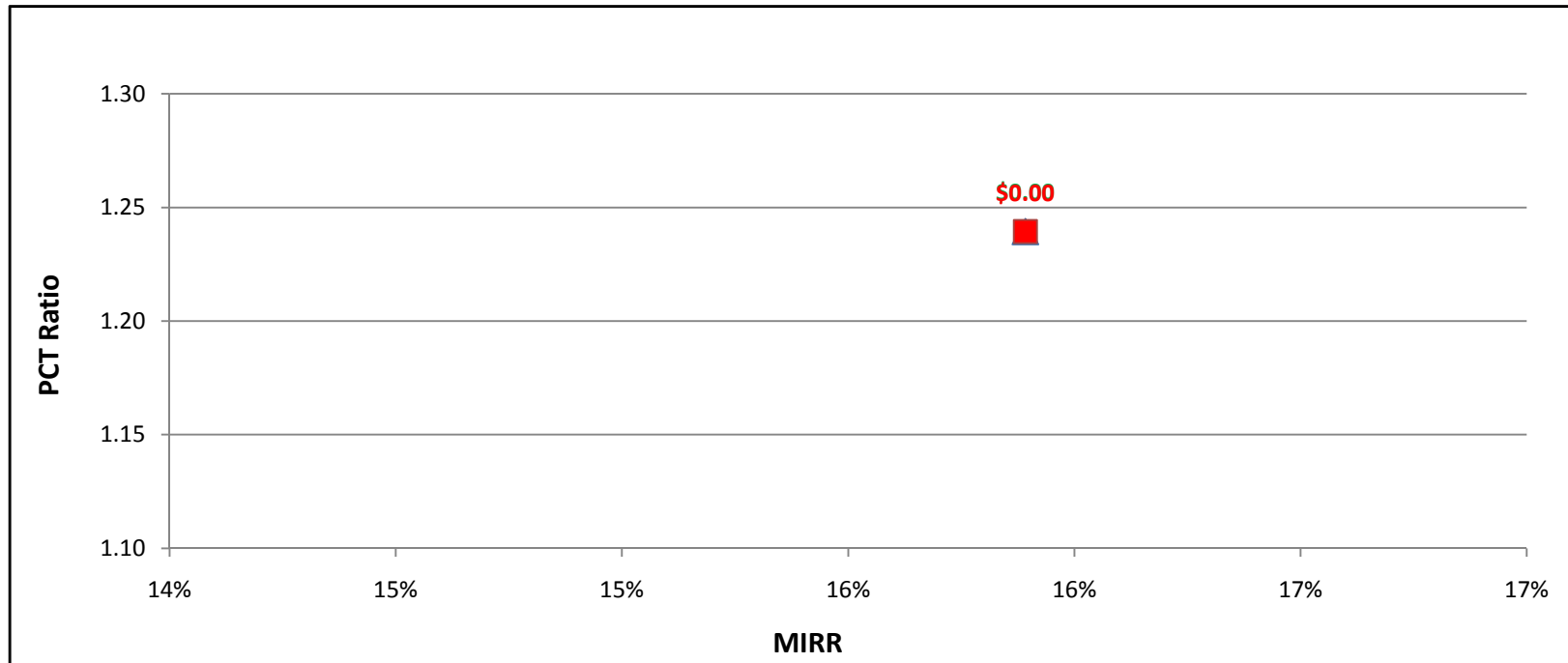

SGIP Cost Effectiveness Report
Participant Test Results (PCT)
MIRR Graphs

ICE1500kW w/ Natural Gas - Commercial - SDG&E

	Rebate	MIRR	PCT-2010
▲ Actual Rebate - 2010	\$0.00	11.3%	1.03
■ No Rebate	\$0.00	11.3%	1.03
● Rebate to Reach MIRR of 10%	\$0.00	0.0%	0.00
● Rebate to Reach MIRR of 11%	\$0.00	0.0%	0.00
● Rebate to Reach MIRR of 12%	\$0.26	12.0%	1.05
● Rebate to Reach MIRR of 13%	\$0.69	13.0%	1.08
● Rebate to Reach MIRR of 14%	\$1.17	14.0%	1.12
● Rebate to Reach MIRR of 15%	\$1.79	15.1%	1.16

System Cost per Watt: \$1.81

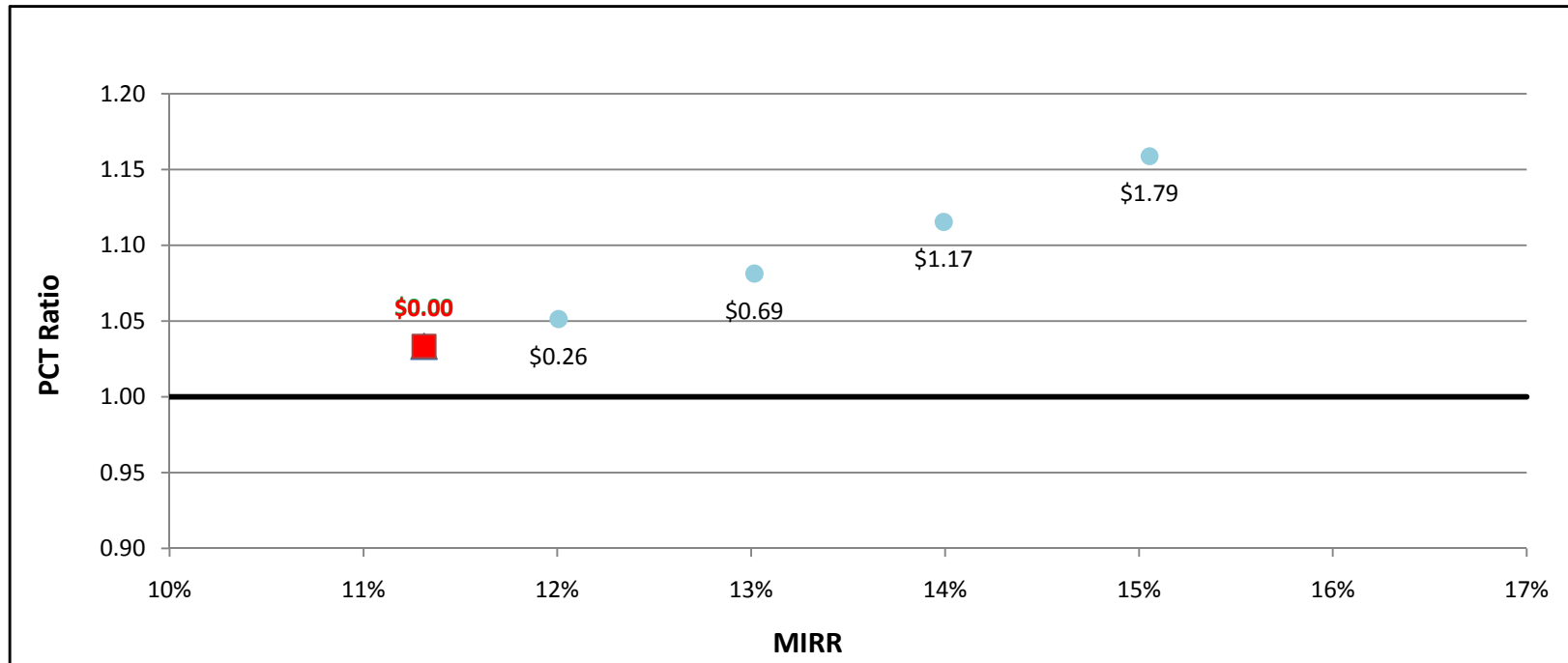

SGIP Cost Effectiveness Report
Participant Test Results (PCT)
MIRR Graphs

ICE1500kW w/ On-Site BioGas - Commercial - PG&E

	Rebate	MIRR	PCT-2010
▲ Actual Rebate - 2010	\$0.00	17.4%	1.81
■ No Rebate	\$0.00	17.4%	1.81
● Rebate to Reach MIRR of 10%	\$0.00	0.0%	0.00
● Rebate to Reach MIRR of 11%	\$0.00	0.0%	0.00
● Rebate to Reach MIRR of 12%	\$0.00	0.0%	0.00
● Rebate to Reach MIRR of 13%	\$0.00	0.0%	0.00
● Rebate to Reach MIRR of 14%	\$0.00	0.0%	0.00
● Rebate to Reach MIRR of 15%	\$0.00	0.0%	0.00

System Cost per Watt: \$1.96



SGIP Cost Effectiveness Report
Participant Test Results (PCT)
MIRR Graphs

ICE1500kW w/ On-Site BioGas - Commercial - SCE

	Rebate	MIRR	PCT-2010
▲ Actual Rebate - 2010	\$0.00	17.5%	1.82
■ No Rebate	\$0.00	17.5%	1.82
● Rebate to Reach MIRR of 10%	\$0.00	0.0%	0.00
● Rebate to Reach MIRR of 11%	\$0.00	0.0%	0.00
● Rebate to Reach MIRR of 12%	\$0.00	0.0%	0.00
● Rebate to Reach MIRR of 13%	\$0.00	0.0%	0.00
● Rebate to Reach MIRR of 14%	\$0.00	0.0%	0.00
● Rebate to Reach MIRR of 15%	\$0.00	0.0%	0.00

System Cost per Watt: \$1.96



SGIP Cost Effectiveness Report
 Participant Test Results (PCT)
 MIRR Graphs

ICE1500kW w/ On-Site BioGas - Commercial - SDG&E

	Rebate	MIRR	PCT-2010
▲ Actual Rebate - 2010	\$0.00	15.7%	1.54
■ No Rebate	\$0.00	15.7%	1.54
● Rebate to Reach MIRR of 10%	\$0.00	0.0%	0.00
● Rebate to Reach MIRR of 11%	\$0.00	0.0%	0.00
● Rebate to Reach MIRR of 12%	\$0.00	0.0%	0.00
● Rebate to Reach MIRR of 13%	\$0.00	0.0%	0.00
● Rebate to Reach MIRR of 14%	\$0.00	0.0%	0.00
● Rebate to Reach MIRR of 15%	\$0.00	0.0%	0.00

System Cost per Watt: \$1.96

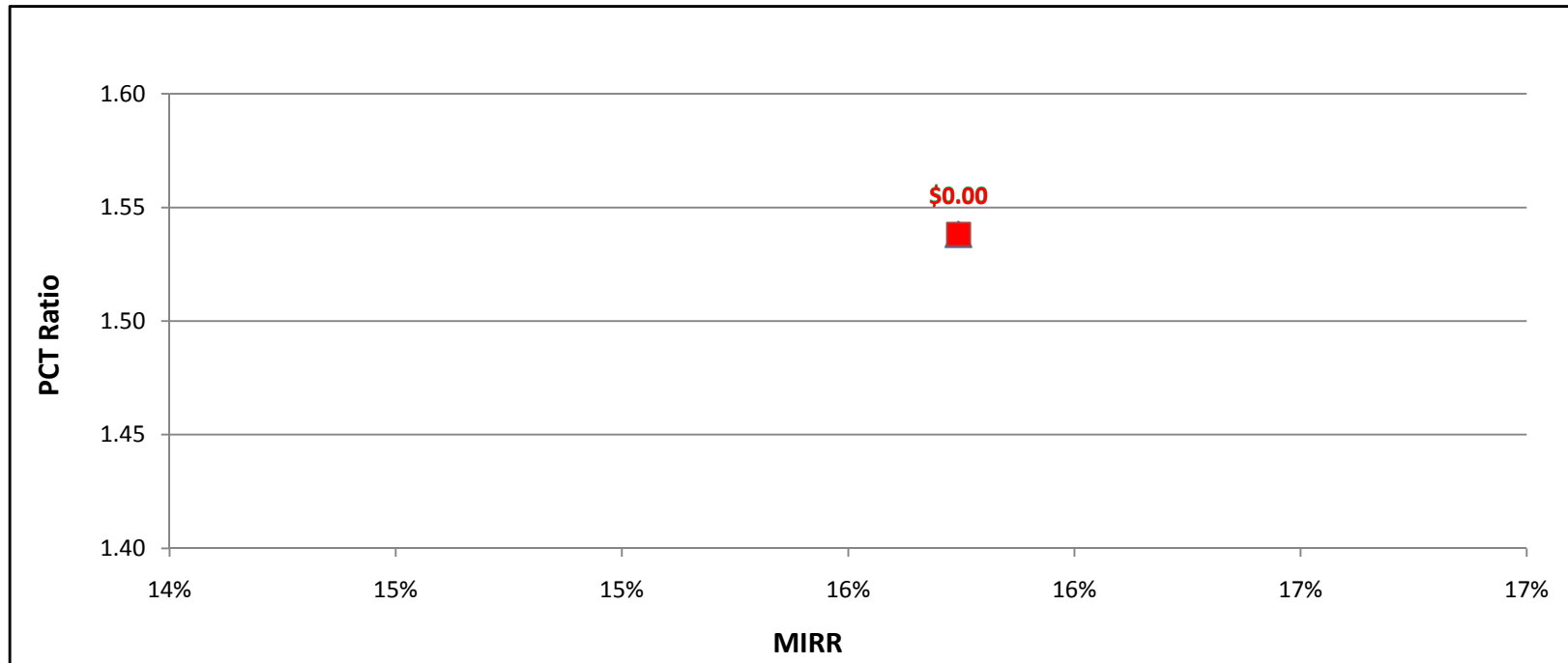

SGIP Cost Effectiveness Report
Participant Test Results (PCT)
MIRR Graphs

ICE500kW w/ Directed BioGas - Government/Non-Profit - PG&E

	Rebate	MIRR	PCT-2010
▲ Actual Rebate - 2010	\$0.00	12.6%	1.17
■ No Rebate	\$0.00	12.6%	1.17
● Rebate to Reach MIRR of 10%	\$0.00	0.0%	0.00
● Rebate to Reach MIRR of 11%	\$0.00	0.0%	0.00
● Rebate to Reach MIRR of 12%	\$0.00	0.0%	0.00
● Rebate to Reach MIRR of 13%	\$0.11	13.0%	1.18
● Rebate to Reach MIRR of 14%	\$0.35	14.0%	1.19
● Rebate to Reach MIRR of 15%	\$0.59	15.1%	1.21

System Cost per Watt: \$2.11

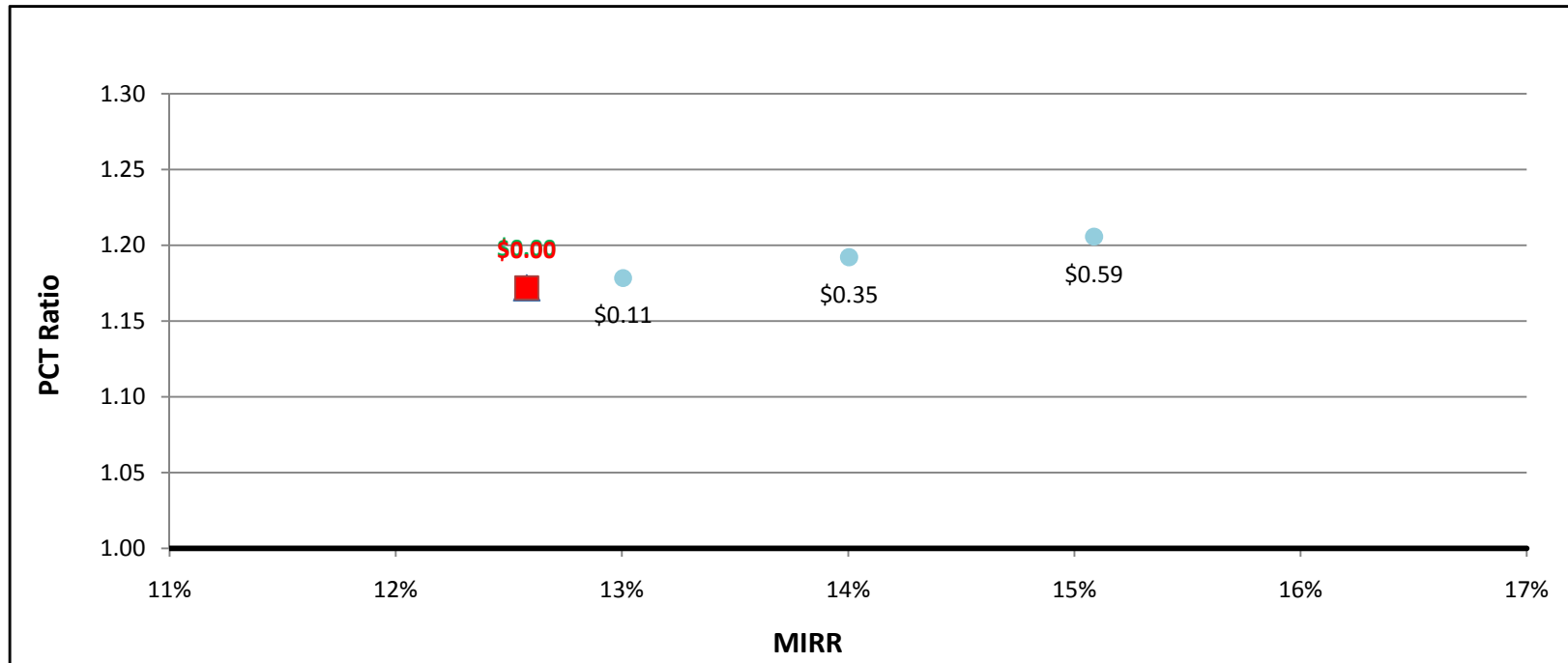

SGIP Cost Effectiveness Report
Participant Test Results (PCT)
MIRR Graphs

ICE500kW w/ Directed BioGas - Government/Non-Profit - SCE

	Rebate	MIRR	PCT-2010
▲ Actual Rebate - 2010	\$0.00	12.7%	1.18
■ No Rebate	\$0.00	12.7%	1.18
● Rebate to Reach MIRR of 10%	\$0.00	0.0%	0.00
● Rebate to Reach MIRR of 11%	\$0.00	0.0%	0.00
● Rebate to Reach MIRR of 12%	\$0.00	0.0%	0.00
● Rebate to Reach MIRR of 13%	\$0.08	13.0%	1.18
● Rebate to Reach MIRR of 14%	\$0.33	14.0%	1.19
● Rebate to Reach MIRR of 15%	\$0.57	15.1%	1.21

System Cost per Watt: \$2.11

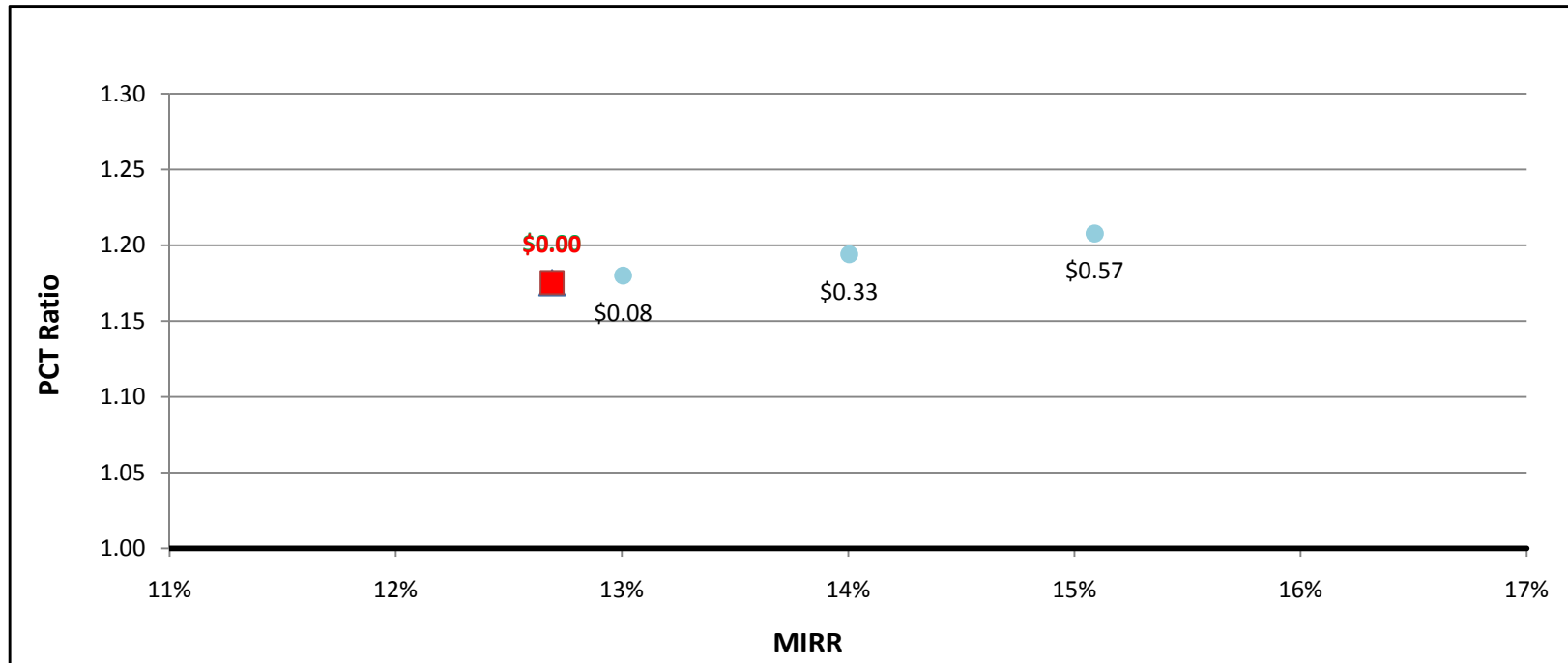

SGIP Cost Effectiveness Report
Participant Test Results (PCT)
MIRR Graphs

ICE500kW w/ Directed BioGas - Government/Non-Profit - SDG&E

	Rebate	MIRR	PCT-2010
▲ Actual Rebate - 2010	\$0.00	-7.4%	0.93
■ No Rebate	\$0.00	-7.4%	0.93
● Rebate to Reach MIRR of 10%	\$1.77	10.0%	1.03
● Rebate to Reach MIRR of 11%	\$1.84	11.0%	1.03
● Rebate to Reach MIRR of 12%	\$1.90	12.0%	1.04
● Rebate to Reach MIRR of 13%	\$1.96	13.1%	1.04
● Rebate to Reach MIRR of 14%	\$2.01	14.0%	1.04
● Rebate to Reach MIRR of 15%	\$2.05	15.0%	1.05

System Cost per Watt: \$2.11

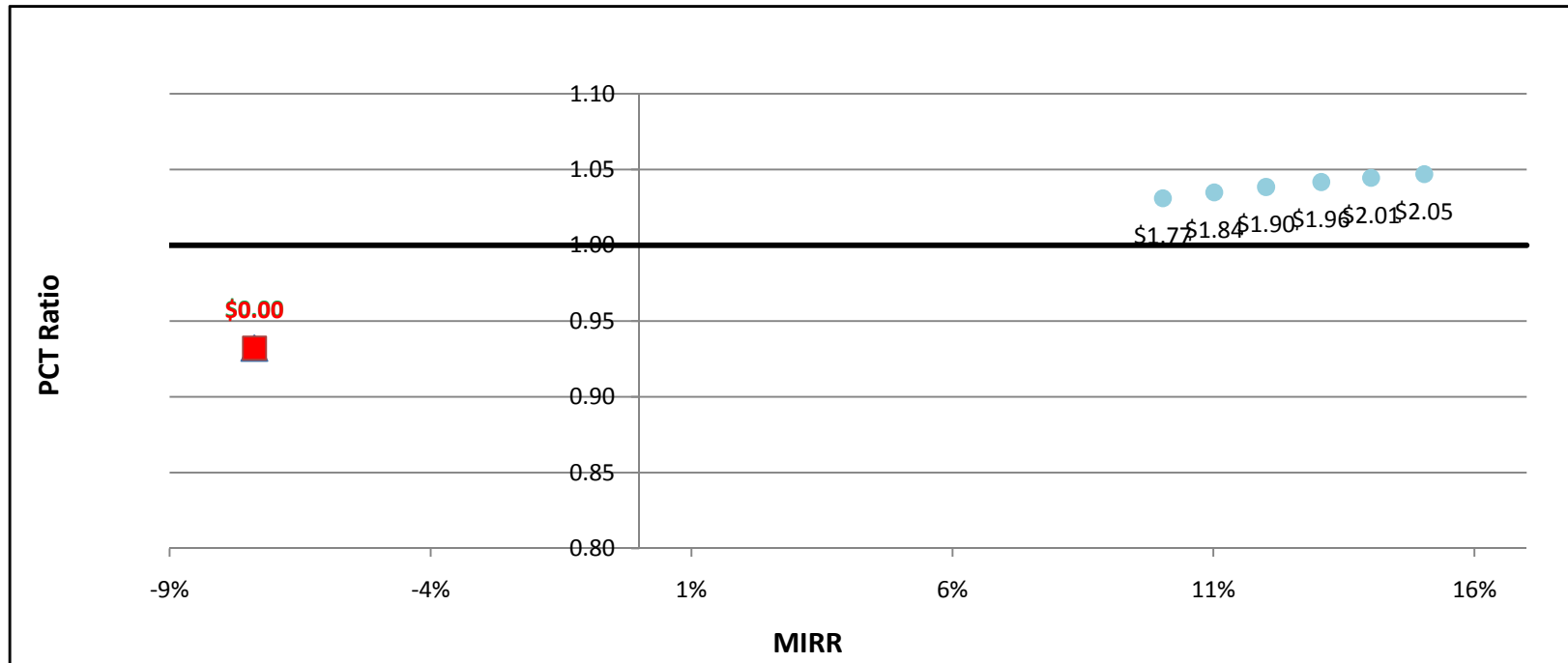

SGIP Cost Effectiveness Report
Participant Test Results (PCT)
MIRR Graphs

ICE500kW w/ Natural Gas - Government/Non-Profit - PG&E

	Rebate	MIRR	PCT-2010
▲ Actual Rebate - 2010	\$0.00	16.1%	1.51
■ No Rebate	\$0.00	16.1%	1.51
● Rebate to Reach MIRR of 10%	\$0.00	0.0%	0.00
● Rebate to Reach MIRR of 11%	\$0.00	0.0%	0.00
● Rebate to Reach MIRR of 12%	\$0.00	0.0%	0.00
● Rebate to Reach MIRR of 13%	\$0.00	0.0%	0.00
● Rebate to Reach MIRR of 14%	\$0.00	0.0%	0.00
● Rebate to Reach MIRR of 15%	\$0.00	0.0%	0.00

System Cost per Watt: \$2.11

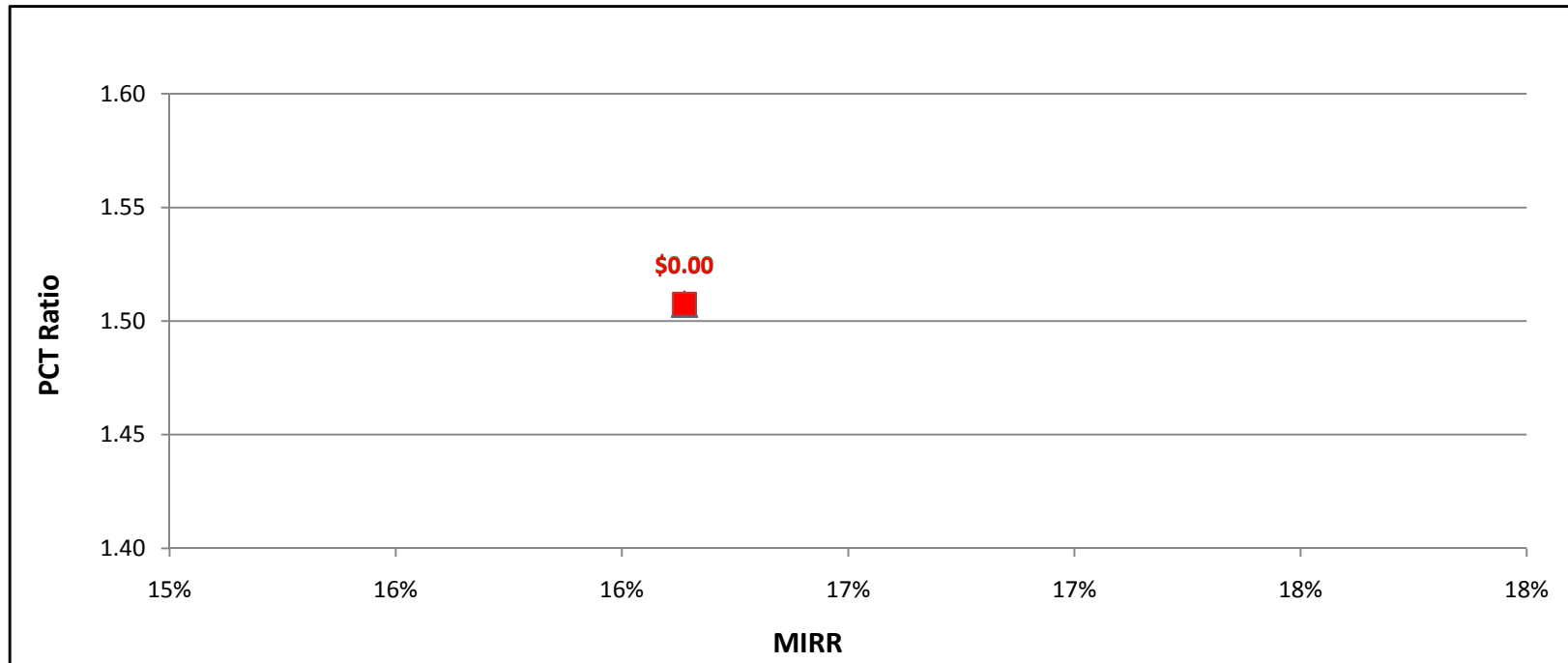

SGIP Cost Effectiveness Report
Participant Test Results (PCT)
MIRR Graphs

ICE500kW w/ Natural Gas - Government/Non-Profit - SCE

	Rebate	MIRR	PCT-2010
▲ Actual Rebate - 2010	\$0.00	16.2%	1.51
■ No Rebate	\$0.00	16.2%	1.51
● Rebate to Reach MIRR of 10%	\$0.00	0.0%	0.00
● Rebate to Reach MIRR of 11%	\$0.00	0.0%	0.00
● Rebate to Reach MIRR of 12%	\$0.00	0.0%	0.00
● Rebate to Reach MIRR of 13%	\$0.00	0.0%	0.00
● Rebate to Reach MIRR of 14%	\$0.00	0.0%	0.00
● Rebate to Reach MIRR of 15%	\$0.00	0.0%	0.00

System Cost per Watt: \$2.11

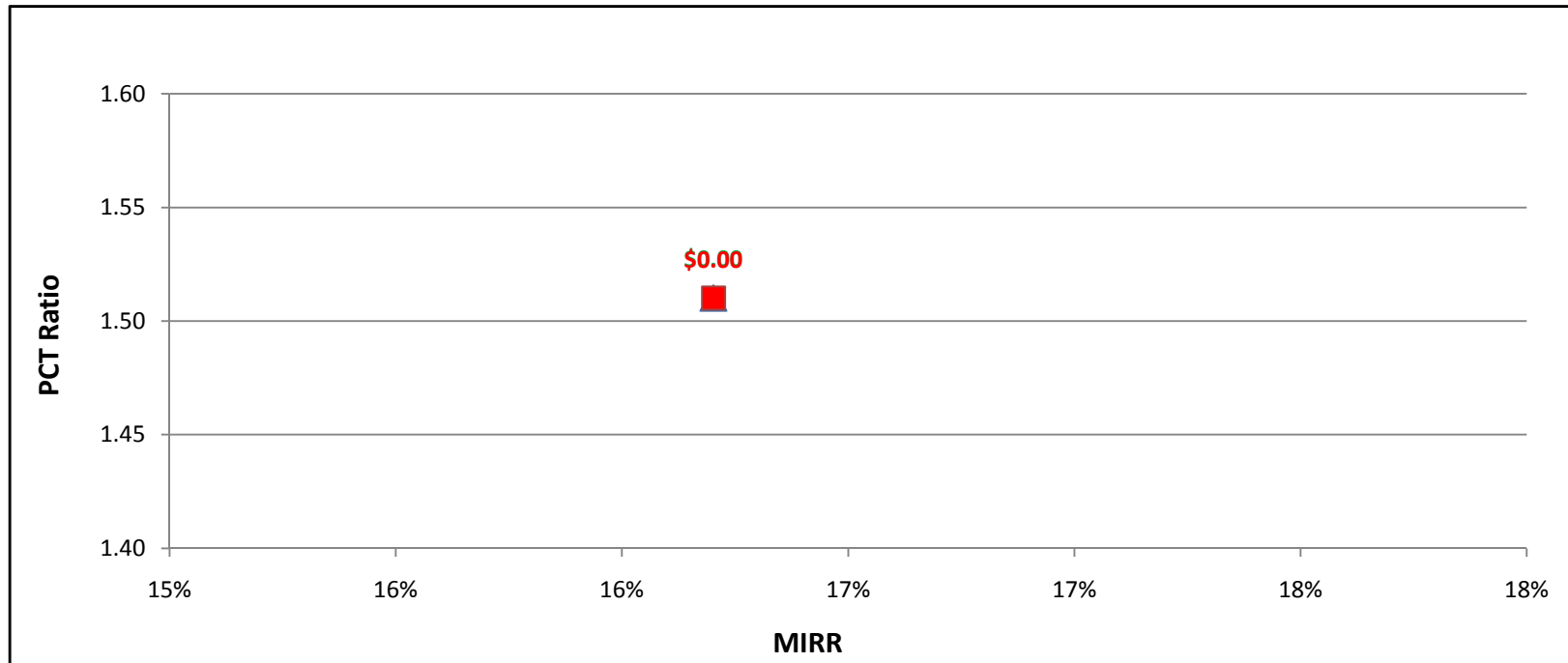

SGIP Cost Effectiveness Report
Participant Test Results (PCT)
MIRR Graphs

ICE500kW w/ Natural Gas - Government/Non-Profit - SDG&E

	Rebate	MIRR	PCT-2010
▲ Actual Rebate - 2010	\$0.00	10.5%	1.15
■ No Rebate	\$0.00	10.5%	1.15
● Rebate to Reach MIRR of 10%	\$0.00	0.0%	0.00
● Rebate to Reach MIRR of 11%	\$0.13	11.1%	1.16
● Rebate to Reach MIRR of 12%	\$0.36	12.1%	1.18
● Rebate to Reach MIRR of 13%	\$0.56	13.1%	1.20
● Rebate to Reach MIRR of 14%	\$0.75	14.1%	1.21
● Rebate to Reach MIRR of 15%	\$0.92	15.0%	1.23

System Cost per Watt: \$2.11

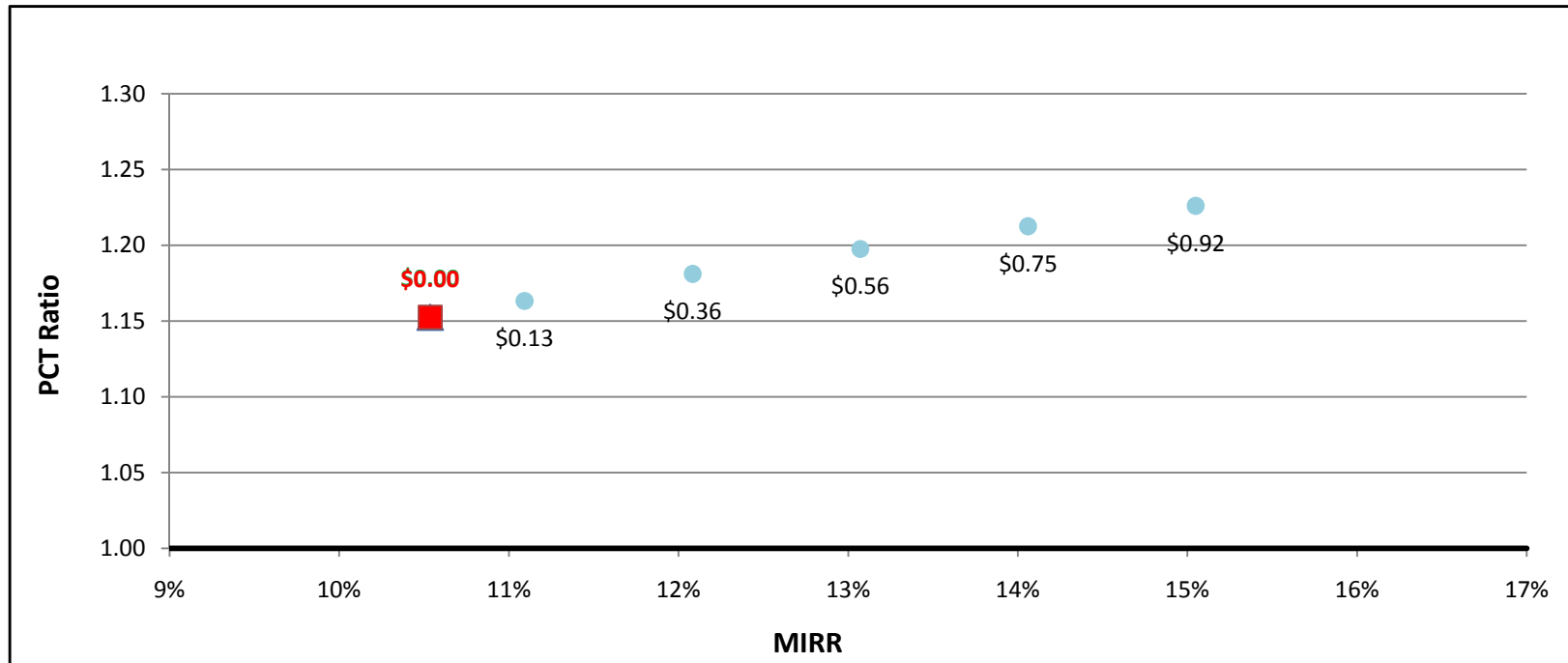

SGIP Cost Effectiveness Report
Participant Test Results (PCT)
MIRR Graphs

ICE500kW w/ On-Site BioGas - Government/Non-Profit - PG&E

	Rebate	MIRR	PCT-2010
▲ Actual Rebate - 2010	\$0.00	9.3%	1.39
■ No Rebate	\$0.00	9.3%	1.39
● Rebate to Reach MIRR of 10%	\$0.61	10.0%	1.43
● Rebate to Reach MIRR of 11%	\$1.47	11.0%	1.49
● Rebate to Reach MIRR of 12%	\$2.33	12.1%	1.55
● Rebate to Reach MIRR of 13%	\$3.03	13.0%	1.60
● Rebate to Reach MIRR of 14%	\$3.69	14.0%	1.64
● Rebate to Reach MIRR of 15%	\$4.32	15.0%	1.68

System Cost per Watt: \$6.00

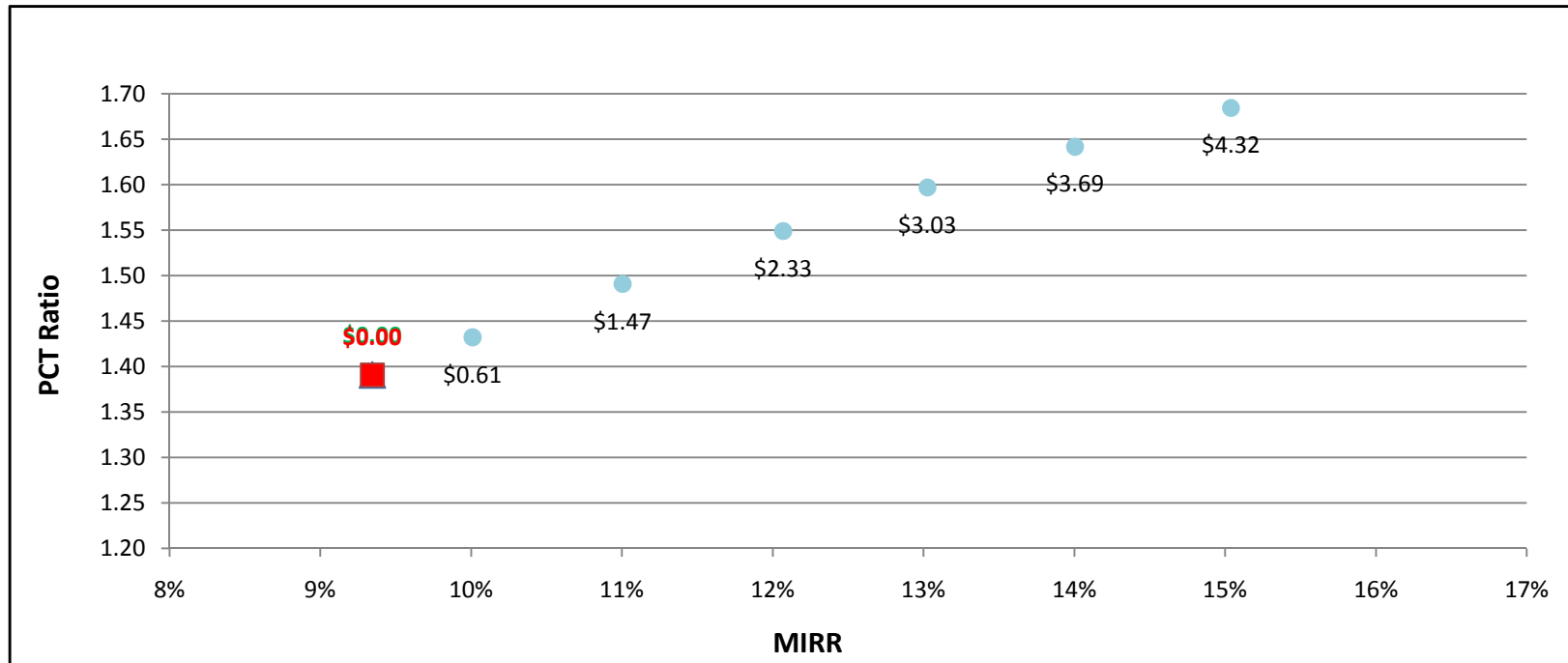

SGIP Cost Effectiveness Report
Participant Test Results (PCT)
MIRR Graphs

ICE500kW w/ On-Site BioGas - Government/Non-Profit - SCE

	Rebate	MIRR	PCT-2010
▲ Actual Rebate - 2010	\$0.00	9.4%	1.40
■ No Rebate	\$0.00	9.4%	1.40
● Rebate to Reach MIRR of 10%	\$0.52	10.0%	1.44
● Rebate to Reach MIRR of 11%	\$1.40	11.0%	1.50
● Rebate to Reach MIRR of 12%	\$2.26	12.1%	1.56
● Rebate to Reach MIRR of 13%	\$2.98	13.0%	1.60
● Rebate to Reach MIRR of 14%	\$3.64	14.0%	1.65
● Rebate to Reach MIRR of 15%	\$4.28	15.0%	1.69

System Cost per Watt: \$6.00

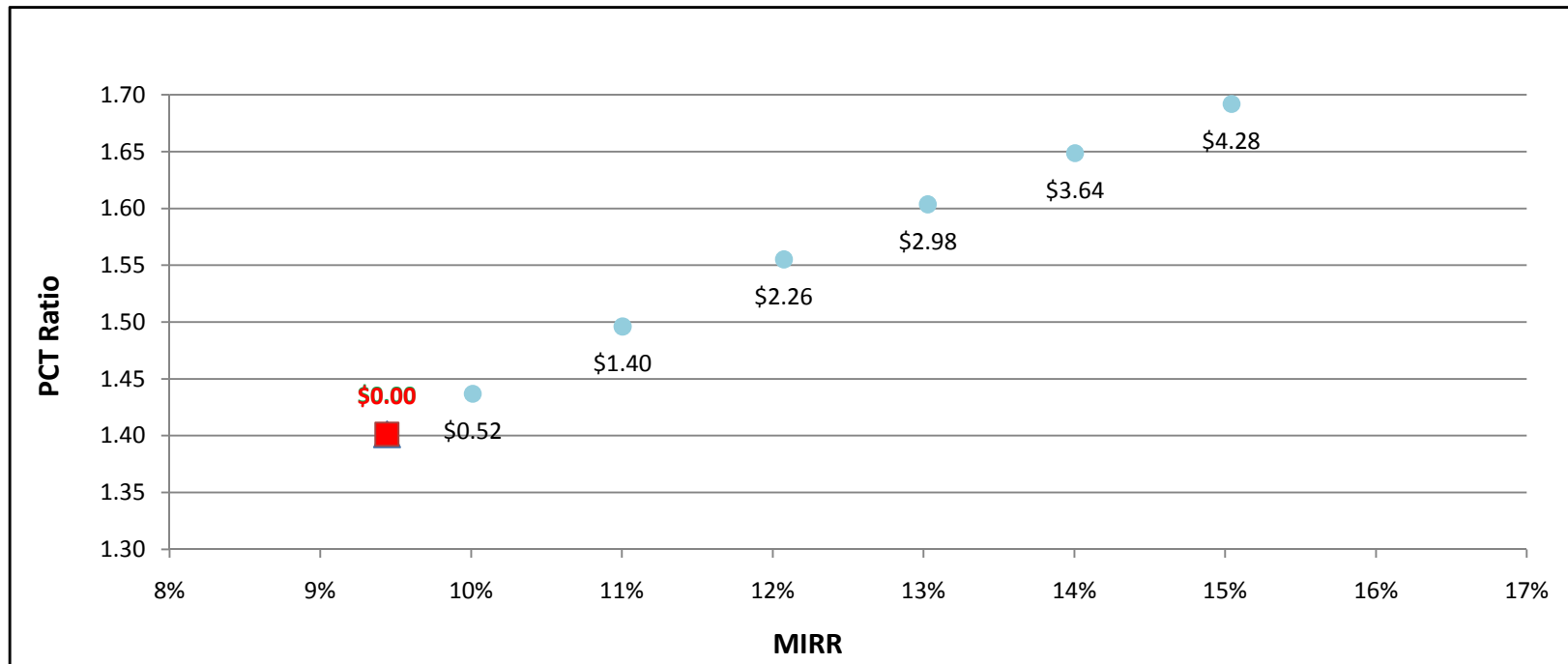

SGIP Cost Effectiveness Report
Participant Test Results (PCT)
MIRR Graphs

ICE500kW w/ On-Site BioGas - Government/Non-Profit - SDG&E

	Rebate	MIRR	PCT-2010
▲ Actual Rebate - 2010	\$0.00	6.2%	1.13
■ No Rebate	\$0.00	6.2%	1.13
● Rebate to Reach MIRR of 10%	\$2.75	10.0%	1.32
● Rebate to Reach MIRR of 11%	\$3.37	11.0%	1.36
● Rebate to Reach MIRR of 12%	\$3.99	12.1%	1.40
● Rebate to Reach MIRR of 13%	\$4.51	13.0%	1.44
● Rebate to Reach MIRR of 14%	\$5.03	14.1%	1.47
● Rebate to Reach MIRR of 15%	\$5.48	15.1%	1.50

System Cost per Watt: \$6.00

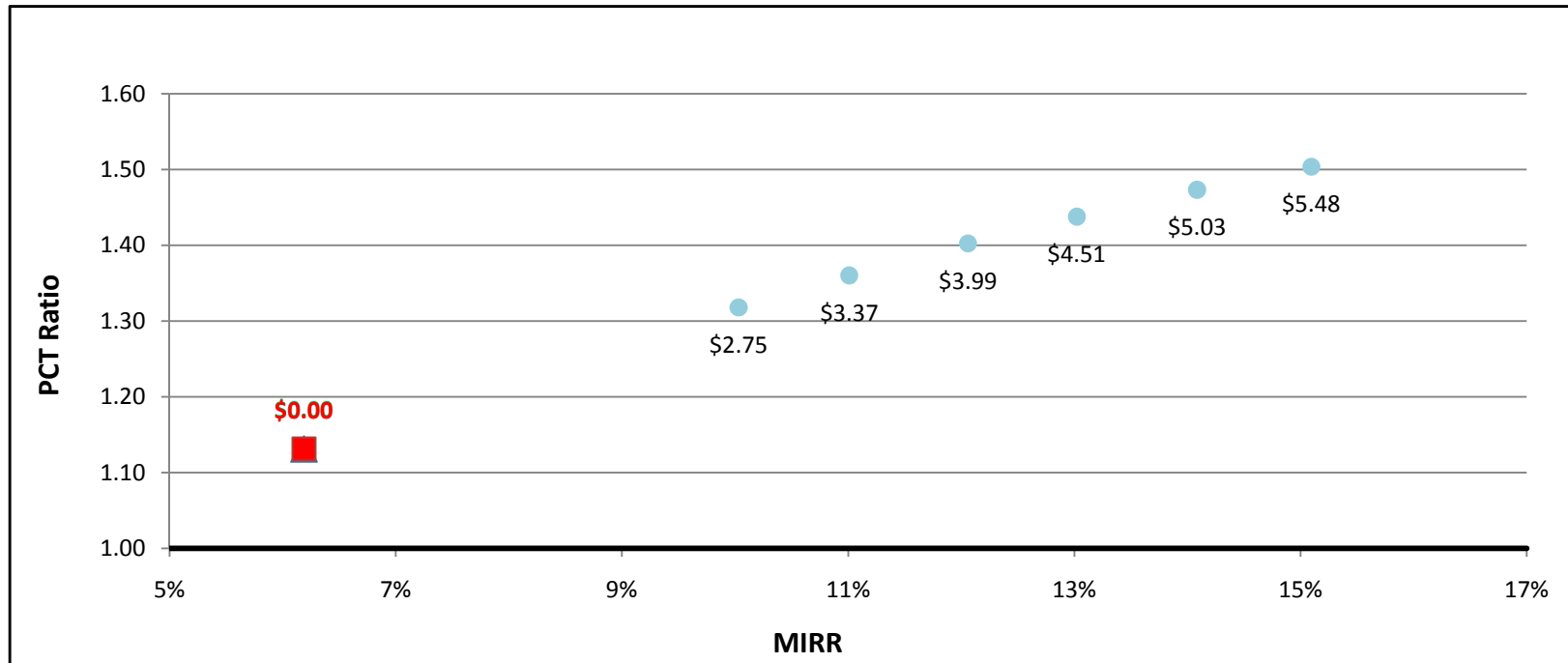

SGIP Cost Effectiveness Report
Participant Test Results (PCT)
MIRR Graphs

ICE500kW w/ Directed BioGas - Commercial - PG&E

	Rebate	MIRR	PCT-2010
▲ Actual Rebate - 2010	\$0.00	11.0%	1.02
■ No Rebate	\$0.00	11.0%	1.02
● Rebate to Reach MIRR of 10%	\$0.00	0.0%	0.00
● Rebate to Reach MIRR of 11%	\$0.02	11.1%	1.02
● Rebate to Reach MIRR of 12%	\$0.39	11.9%	1.04
● Rebate to Reach MIRR of 13%	\$0.92	13.0%	1.06
● Rebate to Reach MIRR of 14%	\$1.47	14.0%	1.09
● Rebate to Reach MIRR of 15%	\$0.00	0.0%	0.00

System Cost per Watt: \$2.11



SGIP Cost Effectiveness Report
Participant Test Results (PCT)
MIRR Graphs

ICE500kW w/ Directed BioGas - Commercial - SCE

	Rebate	MIRR	PCT-2010
▲ Actual Rebate - 2010	\$0.00	11.1%	1.02
■ No Rebate	\$0.00	11.1%	1.02
● Rebate to Reach MIRR of 10%	\$0.00	0.0%	0.00
● Rebate to Reach MIRR of 11%	\$0.00	0.0%	0.00
● Rebate to Reach MIRR of 12%	\$0.34	11.9%	1.04
● Rebate to Reach MIRR of 13%	\$0.88	13.0%	1.06
● Rebate to Reach MIRR of 14%	\$1.44	14.0%	1.09
● Rebate to Reach MIRR of 15%	\$0.00	0.0%	0.00

System Cost per Watt: \$2.11

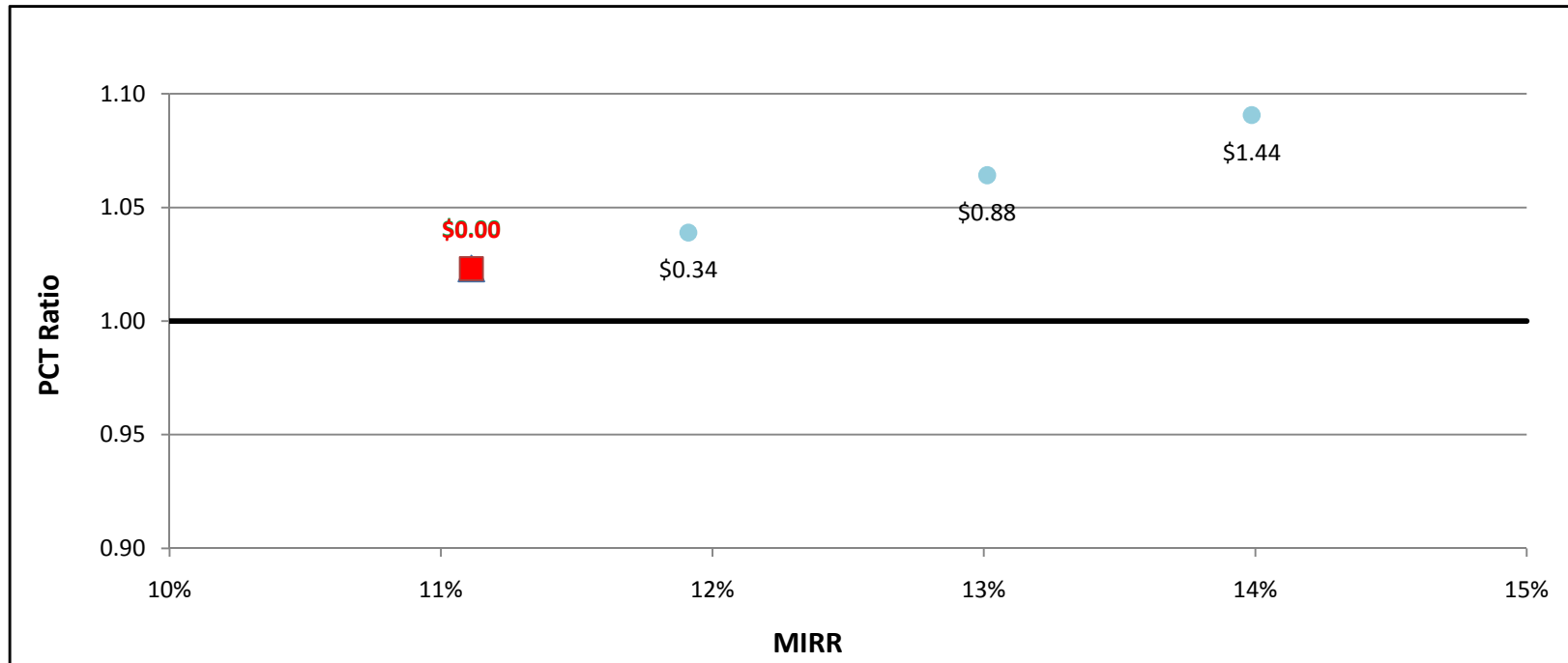

SGIP Cost Effectiveness Report
 Participant Test Results (PCT)
 MIRR Graphs

ICE500kW w/ Directed BioGas - Commercial - SDG&E

	Rebate	MIRR	PCT-2010
▲ Actual Rebate - 2010	\$0.00	1.6%	0.89
■ No Rebate	\$0.00	1.6%	0.89
● Rebate to Reach MIRR of 10%	\$2.09	10.0%	0.99
● Rebate to Reach MIRR of 11%	\$0.00	0.0%	0.00
● Rebate to Reach MIRR of 12%	\$0.00	0.0%	0.00
● Rebate to Reach MIRR of 13%	\$0.00	0.0%	0.00
● Rebate to Reach MIRR of 14%	\$0.00	0.0%	0.00
● Rebate to Reach MIRR of 15%	\$0.00	0.0%	0.00

System Cost per Watt: \$2.11

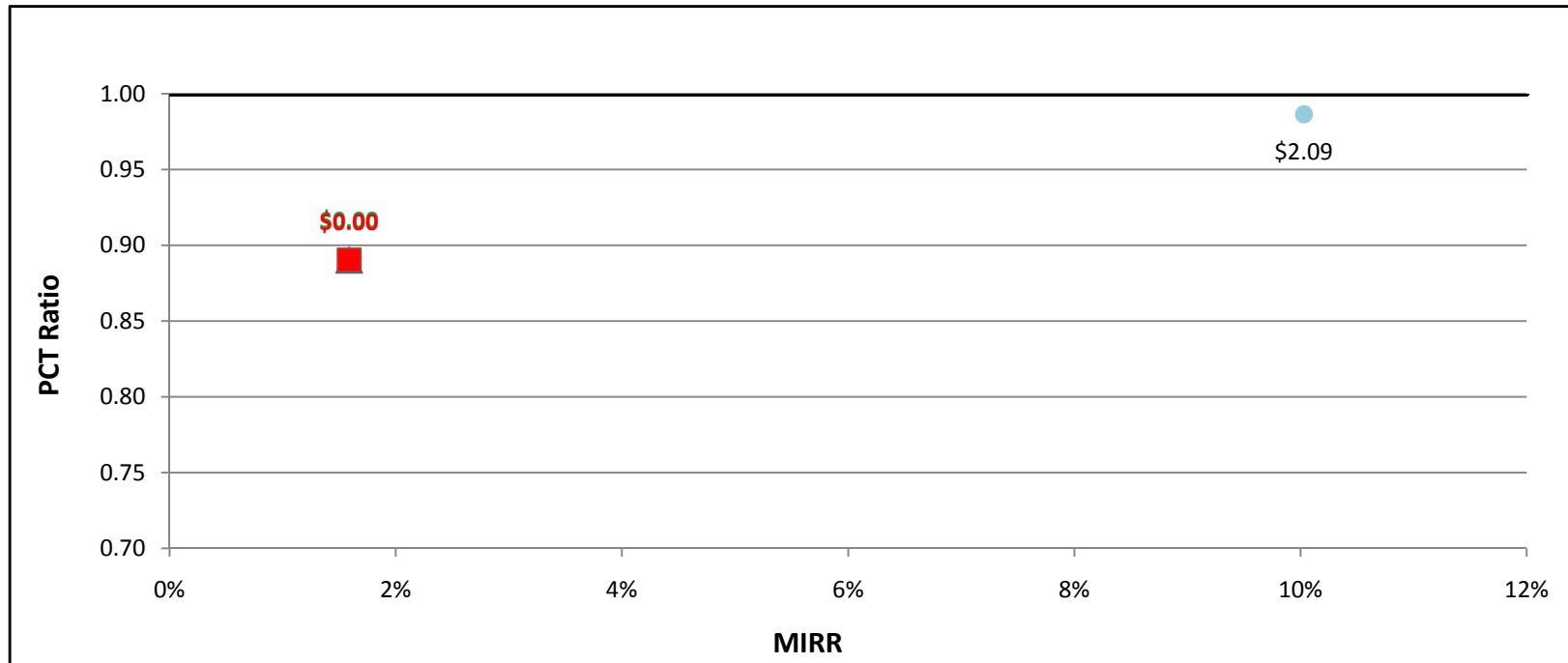

SGIP Cost Effectiveness Report
 Participant Test Results (PCT)
 MIRR Graphs

ICE500kW w/ Natural Gas - Commercial - PG&E

	Rebate	MIRR	PCT-2010
▲ Actual Rebate - 2010	\$0.00	14.5%	1.18
■ No Rebate	\$0.00	14.5%	1.18
● Rebate to Reach MIRR of 10%	\$0.00	0.0%	0.00
● Rebate to Reach MIRR of 11%	\$0.00	0.0%	0.00
● Rebate to Reach MIRR of 12%	\$0.00	0.0%	0.00
● Rebate to Reach MIRR of 13%	\$0.00	0.0%	0.00
● Rebate to Reach MIRR of 14%	\$0.00	0.0%	0.00
● Rebate to Reach MIRR of 15%	\$0.31	15.0%	1.20

System Cost per Watt: \$2.11

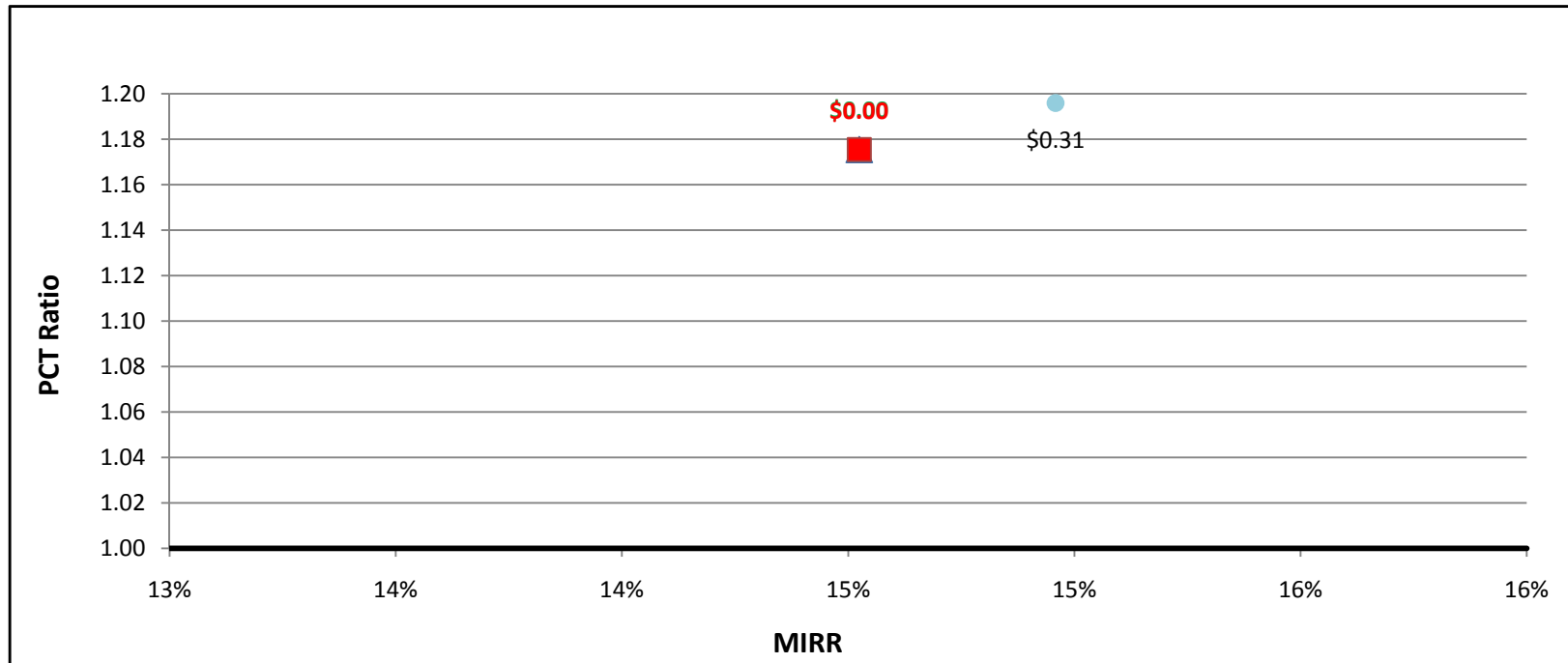

SGIP Cost Effectiveness Report
Participant Test Results (PCT)
MIRR Graphs

ICE500kW w/ Natural Gas - Commercial - SCE

	Rebate	MIRR	PCT-2010
▲ Actual Rebate - 2010	\$0.00	14.6%	1.18
■ No Rebate	\$0.00	14.6%	1.18
● Rebate to Reach MIRR of 10%	\$0.00	0.0%	0.00
● Rebate to Reach MIRR of 11%	\$0.00	0.0%	0.00
● Rebate to Reach MIRR of 12%	\$0.00	0.0%	0.00
● Rebate to Reach MIRR of 13%	\$0.00	0.0%	0.00
● Rebate to Reach MIRR of 14%	\$0.00	0.0%	0.00
● Rebate to Reach MIRR of 15%	\$0.25	14.9%	1.19

System Cost per Watt: \$2.11

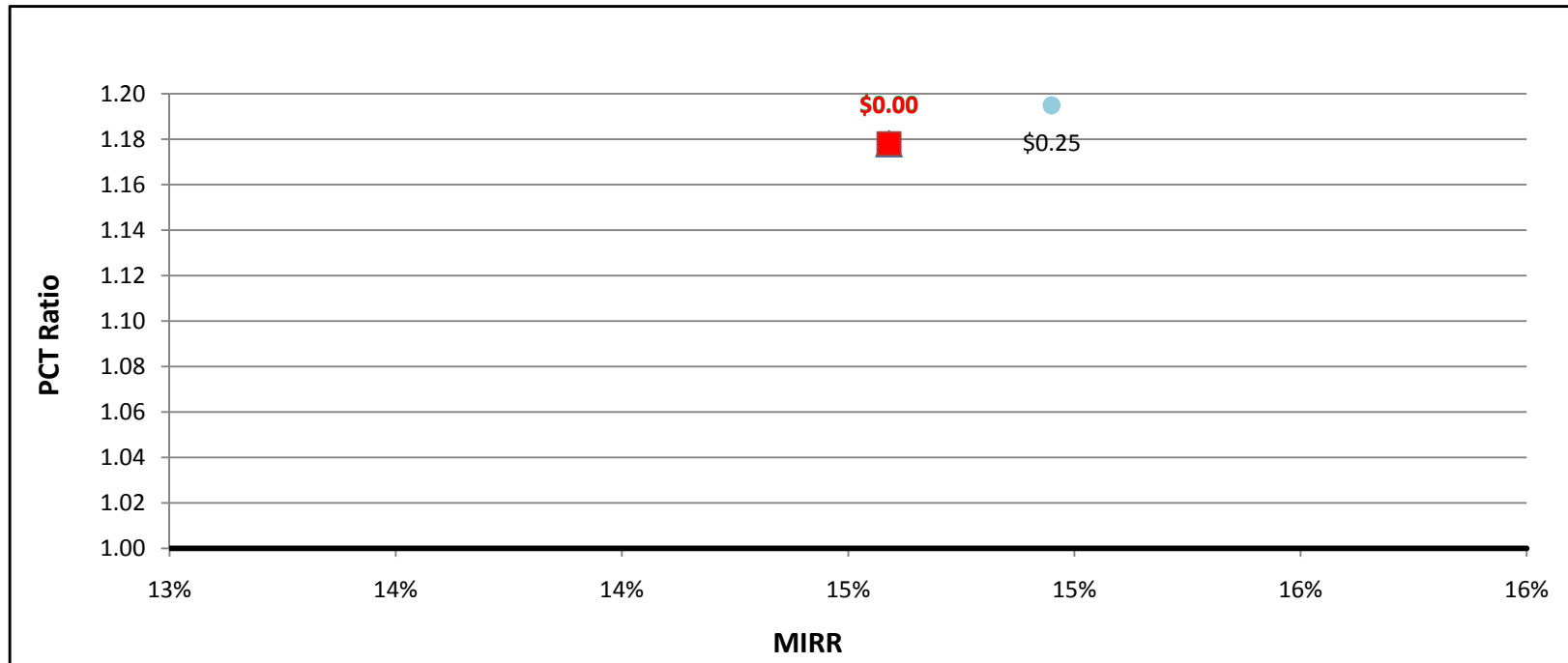

SGIP Cost Effectiveness Report
Participant Test Results (PCT)
MIRR Graphs

ICE500kW w/ Natural Gas - Commercial - SDG&E

	Rebate	MIRR	PCT-2010
▲ Actual Rebate - 2010	\$0.00	9.6%	0.99
■ No Rebate	\$0.00	9.6%	0.99
● Rebate to Reach MIRR of 10%	\$0.16	10.0%	1.00
● Rebate to Reach MIRR of 11%	\$0.48	10.9%	1.02
● Rebate to Reach MIRR of 12%	\$0.93	12.0%	1.05
● Rebate to Reach MIRR of 13%	\$1.44	13.1%	1.08
● Rebate to Reach MIRR of 14%	\$1.99	14.0%	1.12
● Rebate to Reach MIRR of 15%	\$0.00	0.0%	0.00

System Cost per Watt: \$2.11

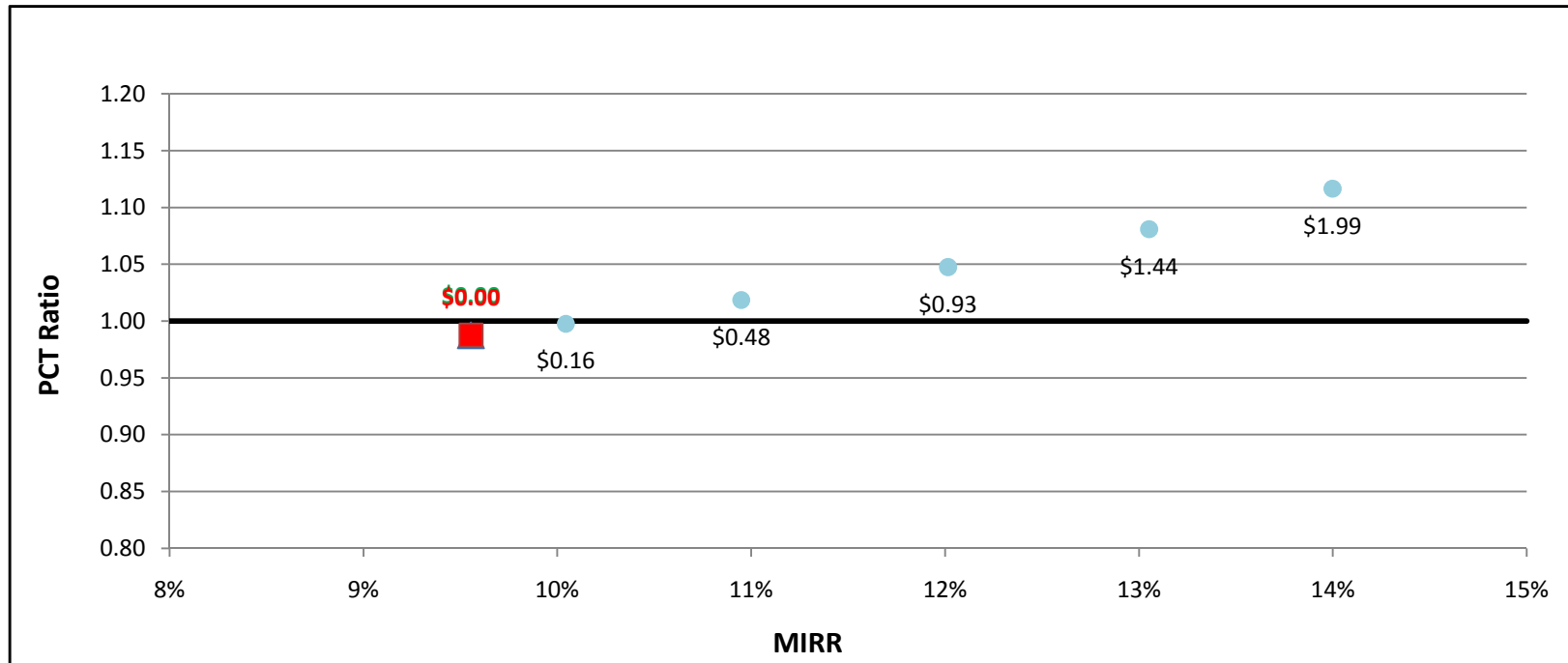

SGIP Cost Effectiveness Report
 Participant Test Results (PCT)
 MIRR Graphs

ICE500kW w/ On-Site BioGas - Commercial - PG&E

	Rebate	MIRR	PCT-2010
▲ Actual Rebate - 2010	\$0.00	10.7%	1.06
■ No Rebate	\$0.00	10.7%	1.06
● Rebate to Reach MIRR of 10%	\$0.00	0.0%	0.00
● Rebate to Reach MIRR of 11%	\$0.43	11.0%	1.08
● Rebate to Reach MIRR of 12%	\$2.15	12.0%	1.16
● Rebate to Reach MIRR of 13%	\$4.13	13.0%	1.26
● Rebate to Reach MIRR of 14%	\$0.00	0.0%	0.00
● Rebate to Reach MIRR of 15%	\$0.00	0.0%	0.00

System Cost per Watt: \$6.00

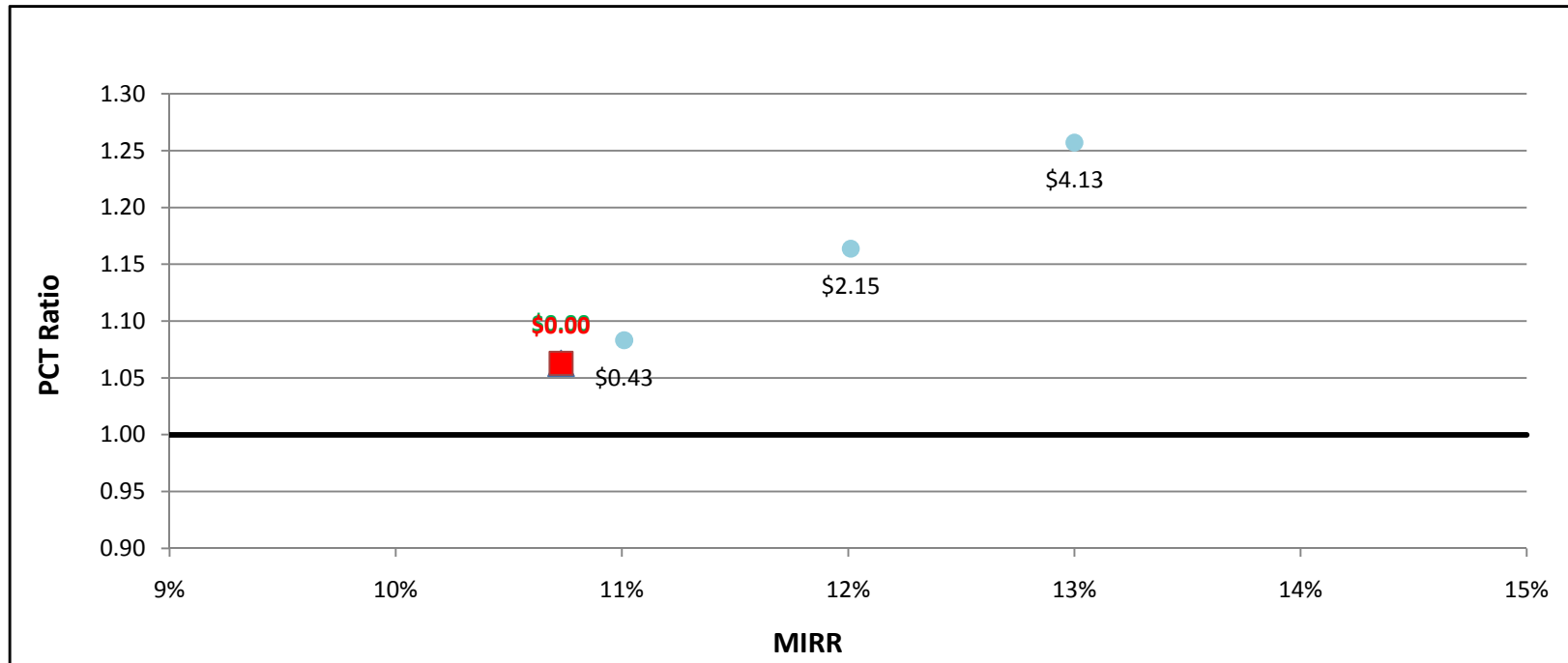

SGIP Cost Effectiveness Report
 Participant Test Results (PCT)
 MIRR Graphs

ICE500kW w/ On-Site BioGas - Commercial - SCE

	Rebate	MIRR	PCT-2010
▲ Actual Rebate - 2010	\$0.00	10.8%	1.07
■ No Rebate	\$0.00	10.8%	1.07
● Rebate to Reach MIRR of 10%	\$0.00	0.0%	0.00
● Rebate to Reach MIRR of 11%	\$0.34	11.0%	1.08
● Rebate to Reach MIRR of 12%	\$2.06	12.0%	1.16
● Rebate to Reach MIRR of 13%	\$4.13	13.0%	1.26
● Rebate to Reach MIRR of 14%	\$0.00	0.0%	0.00
● Rebate to Reach MIRR of 15%	\$0.00	0.0%	0.00

System Cost per Watt: \$6.00

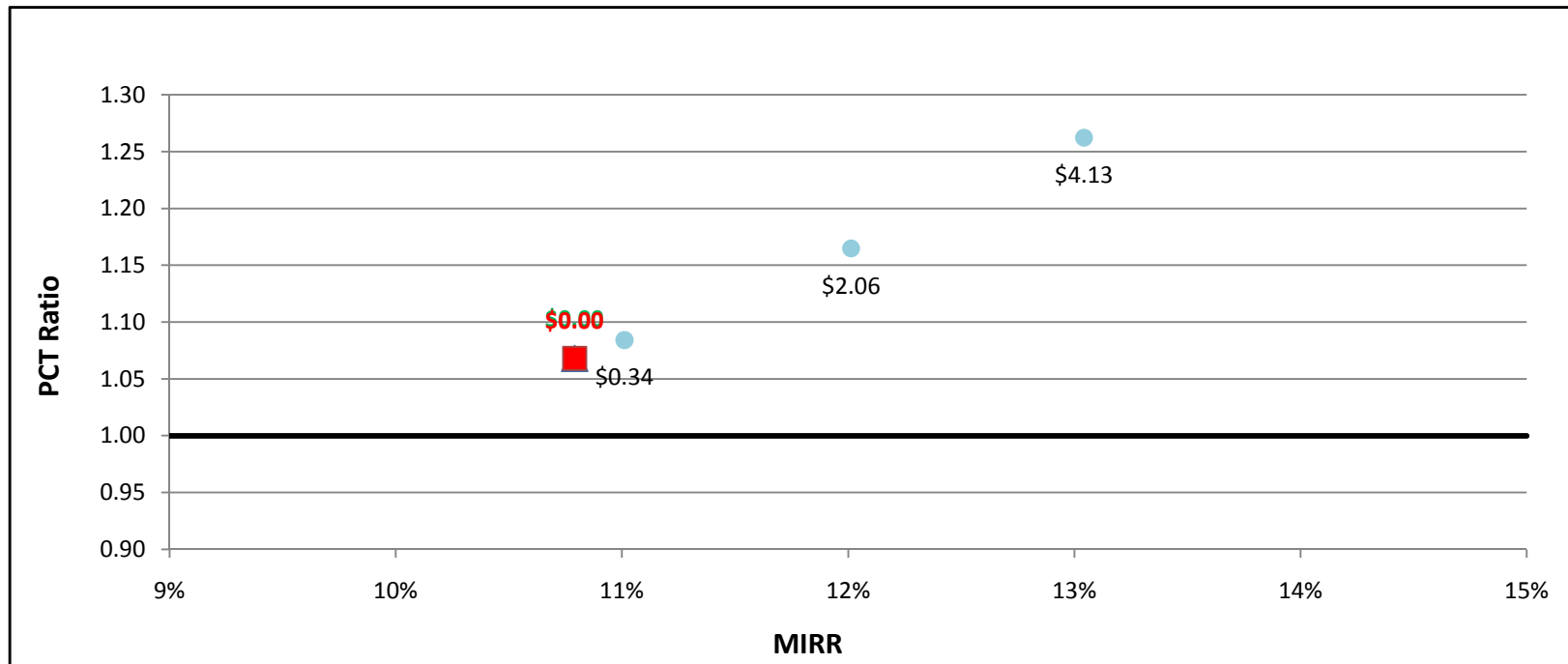

SGIP Cost Effectiveness Report
 Participant Test Results (PCT)
 MIRR Graphs

ICE500kW w/ On-Site BioGas - Commercial - SDG&E

	Rebate	MIRR	PCT-2010
▲ Actual Rebate - 2010	\$0.00	9.1%	0.94
■ No Rebate	\$0.00	9.1%	0.94
● Rebate to Reach MIRR of 10%	\$0.95	9.9%	0.99
● Rebate to Reach MIRR of 11%	\$2.54	11.0%	1.06
● Rebate to Reach MIRR of 12%	\$4.15	12.0%	1.14
● Rebate to Reach MIRR of 13%	\$0.00	0.0%	0.00
● Rebate to Reach MIRR of 14%	\$0.00	0.0%	0.00
● Rebate to Reach MIRR of 15%	\$0.00	0.0%	0.00

System Cost per Watt: \$6.00

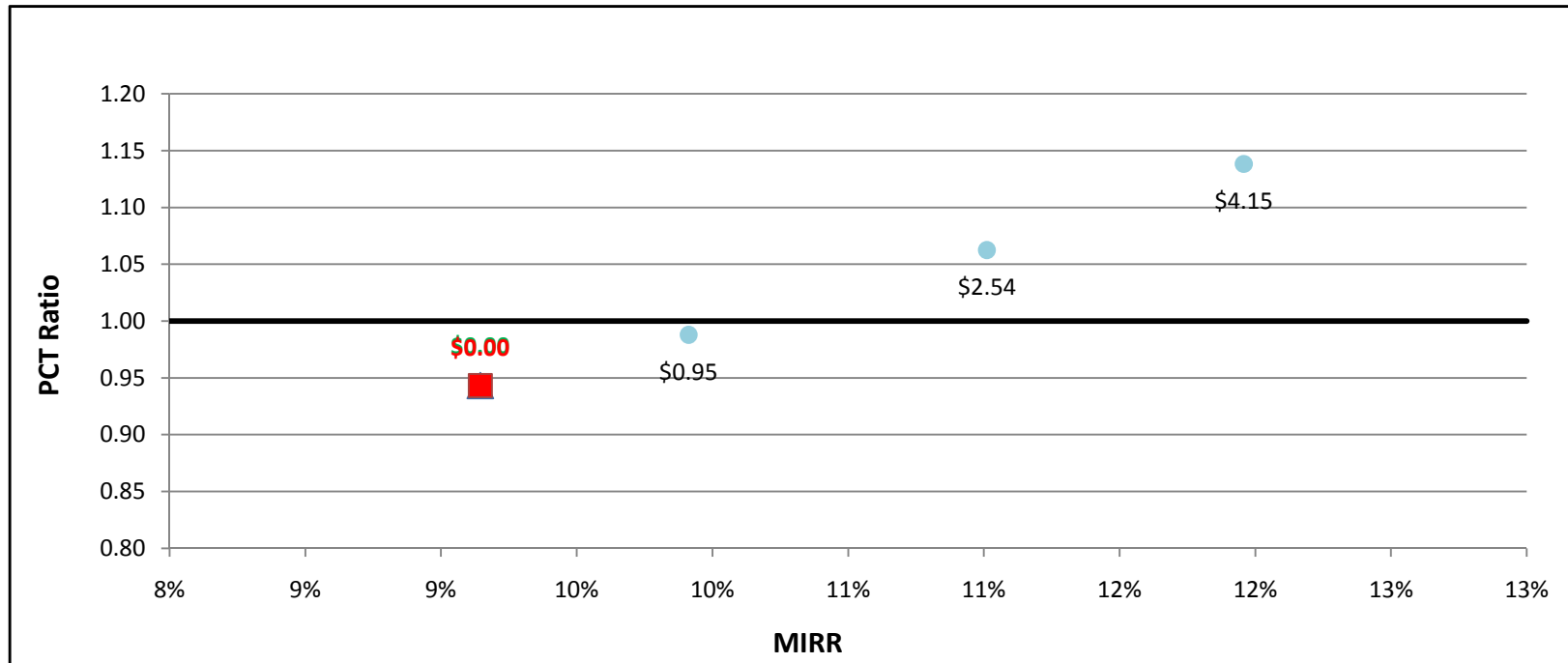

SGIP Cost Effectiveness Report
Participant Test Results (PCT)
MIRR Graphs

MT200kW w/ Directed BioGas - Government/Non-Profit - PG&E

	Rebate	MIRR	PCT-2010
▲ Actual Rebate - 2010	\$0.00	-7.2%	0.94
■ No Rebate	\$0.00	-7.2%	0.94
● Rebate to Reach MIRR of 10%	\$2.33	10.0%	1.03
● Rebate to Reach MIRR of 11%	\$2.42	11.0%	1.03
● Rebate to Reach MIRR of 12%	\$2.51	12.0%	1.04
● Rebate to Reach MIRR of 13%	\$2.60	13.1%	1.04
● Rebate to Reach MIRR of 14%	\$2.67	14.1%	1.04
● Rebate to Reach MIRR of 15%	\$2.73	15.0%	1.05

System Cost per Watt: \$3.18

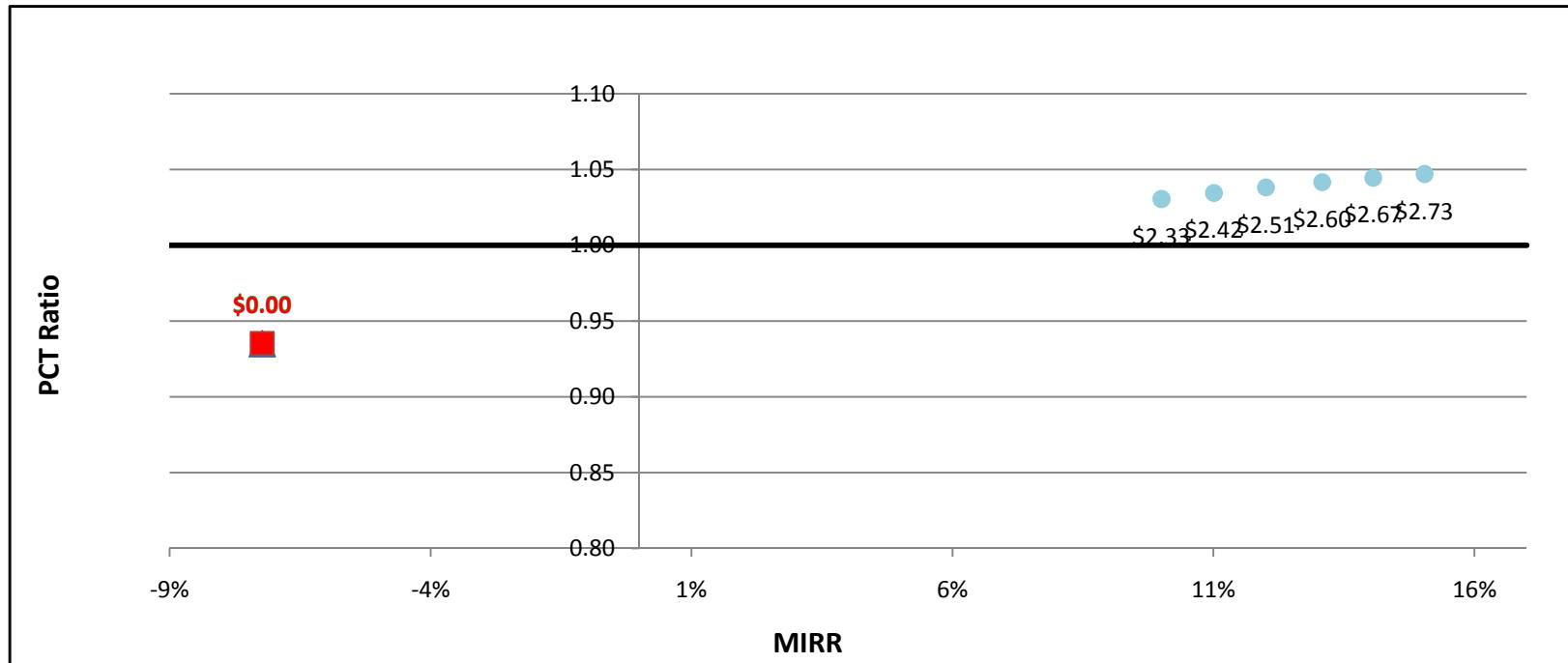

SGIP Cost Effectiveness Report
Participant Test Results (PCT)
MIRR Graphs

MT200kW w/ Directed BioGas - Government/Non-Profit - SCE

	Rebate	MIRR	PCT-2010
▲ Actual Rebate - 2010	\$0.00	-6.9%	0.94
■ No Rebate	\$0.00	-6.9%	0.94
● Rebate to Reach MIRR of 10%	\$2.31	10.0%	1.03
● Rebate to Reach MIRR of 11%	\$2.41	11.0%	1.04
● Rebate to Reach MIRR of 12%	\$2.50	12.0%	1.04
● Rebate to Reach MIRR of 13%	\$2.58	13.1%	1.04
● Rebate to Reach MIRR of 14%	\$2.65	14.1%	1.05
● Rebate to Reach MIRR of 15%	\$2.72	15.0%	1.05

System Cost per Watt: \$3.18

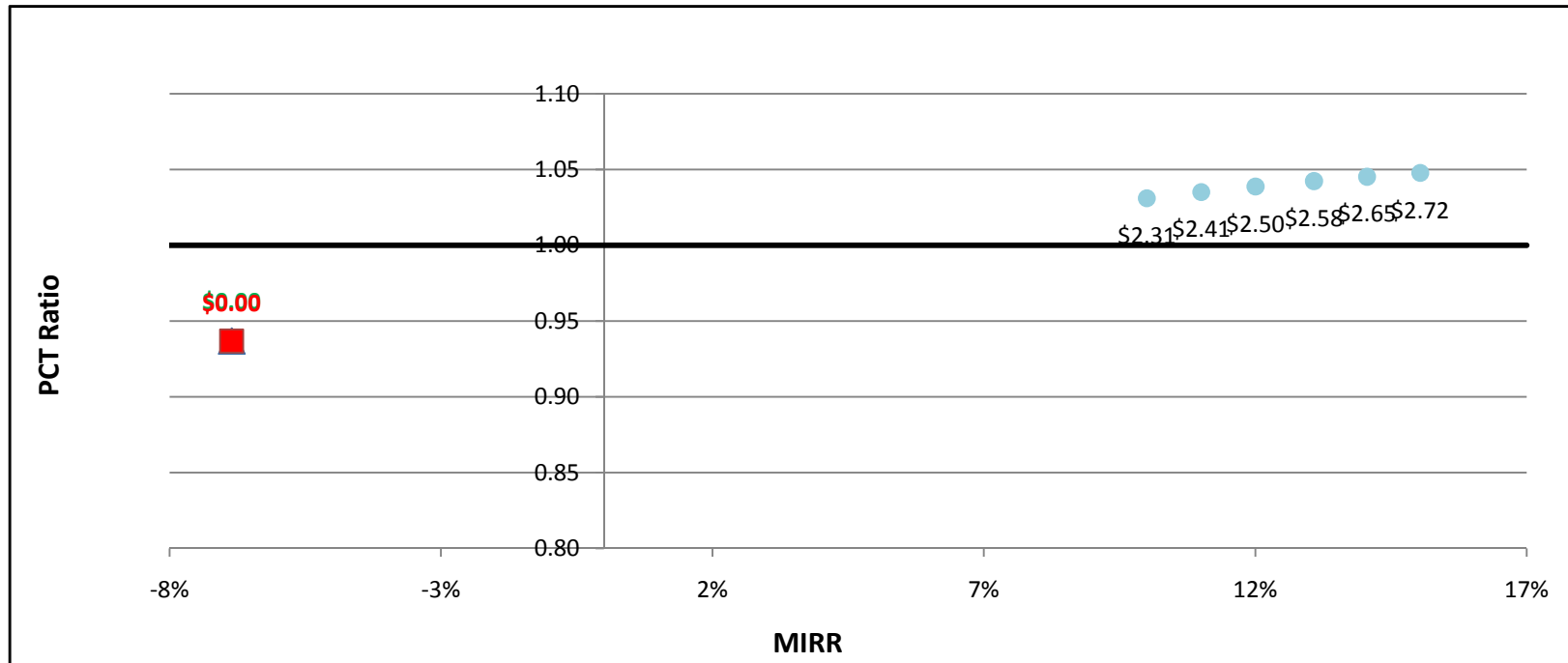

SGIP Cost Effectiveness Report
Participant Test Results (PCT)
MIRR Graphs

MT200kW w/ Directed BioGas - Government/Non-Profit - SDG&E

	Rebate	MIRR	PCT-2010
▲ Actual Rebate - 2010	\$0.00	-100.0%	0.76
■ No Rebate	\$0.00	-100.0%	0.76
● Rebate to Reach MIRR of 10%	\$0.00	0.0%	0.00
● Rebate to Reach MIRR of 11%	\$0.00	0.0%	0.00
● Rebate to Reach MIRR of 12%	\$0.00	0.0%	0.00
● Rebate to Reach MIRR of 13%	\$0.00	0.0%	0.00
● Rebate to Reach MIRR of 14%	\$0.00	0.0%	0.00
● Rebate to Reach MIRR of 15%	\$0.00	0.0%	0.00

System Cost per Watt: \$3.18

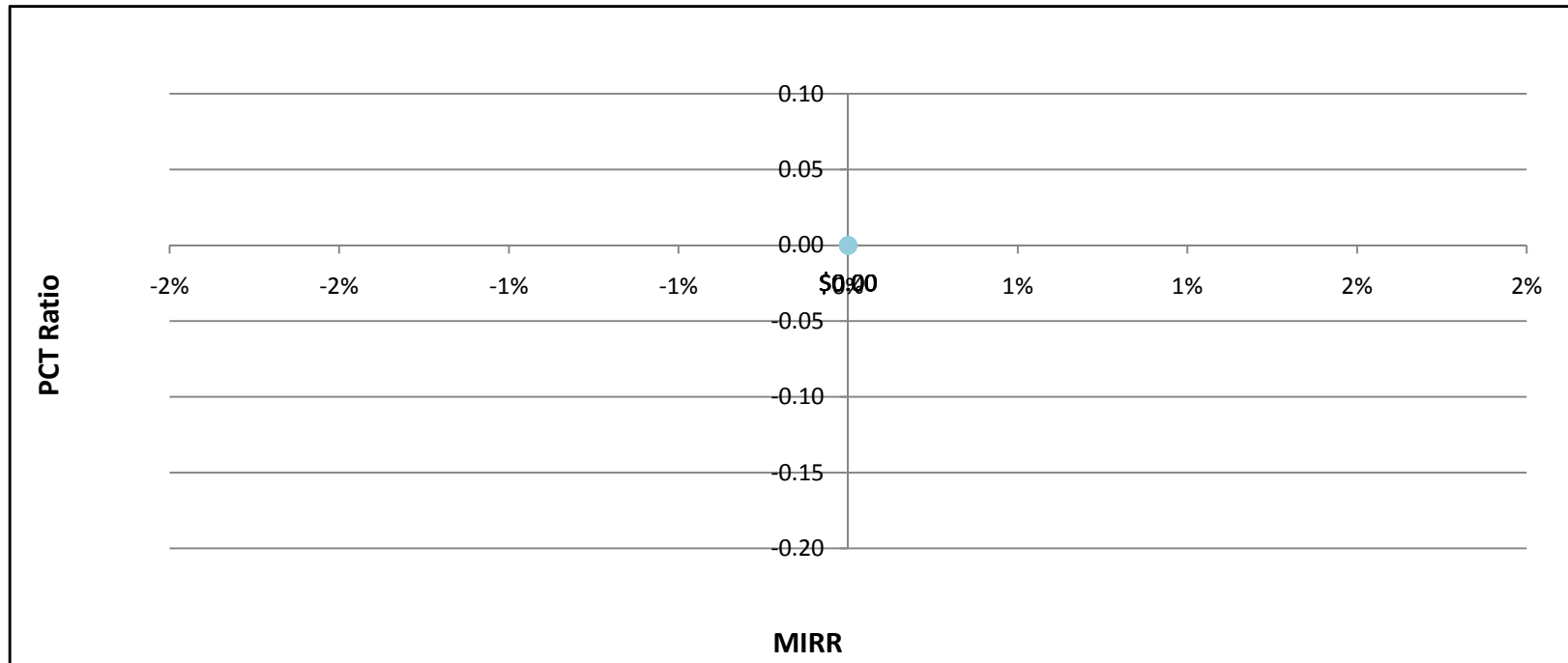

SGIP Cost Effectiveness Report
Participant Test Results (PCT)
MIRR Graphs

MT200kW w/ Natural Gas - Government/Non-Profit - PG&E

	Rebate	MIRR	PCT-2010
▲ Actual Rebate - 2010	\$0.00	11.3%	1.20
■ No Rebate	\$0.00	11.3%	1.20
● Rebate to Reach MIRR of 10%	\$0.00	0.0%	0.00
● Rebate to Reach MIRR of 11%	\$0.00	0.0%	0.00
● Rebate to Reach MIRR of 12%	\$0.25	12.0%	1.22
● Rebate to Reach MIRR of 13%	\$0.60	13.0%	1.24
● Rebate to Reach MIRR of 14%	\$0.91	14.0%	1.26
● Rebate to Reach MIRR of 15%	\$1.19	15.0%	1.27

System Cost per Watt: \$3.18

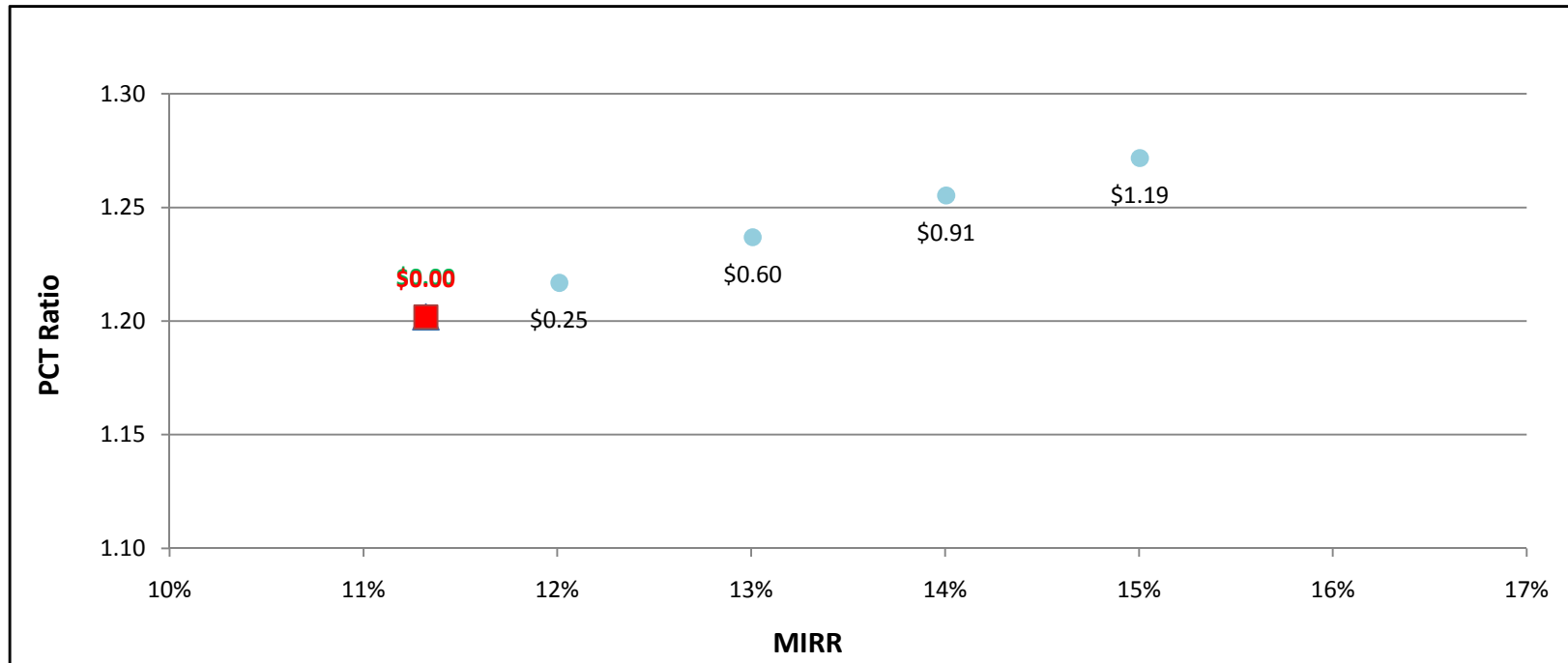

SGIP Cost Effectiveness Report
Participant Test Results (PCT)
MIRR Graphs

MT200kW w/ Natural Gas - Government/Non-Profit - SCE

	Rebate	MIRR	PCT-2010
▲ Actual Rebate - 2010	\$0.00	11.4%	1.20
■ No Rebate	\$0.00	11.4%	1.20
● Rebate to Reach MIRR of 10%	\$0.00	0.0%	0.00
● Rebate to Reach MIRR of 11%	\$0.00	0.0%	0.00
● Rebate to Reach MIRR of 12%	\$0.24	12.0%	1.22
● Rebate to Reach MIRR of 13%	\$0.58	13.0%	1.24
● Rebate to Reach MIRR of 14%	\$0.90	14.0%	1.26
● Rebate to Reach MIRR of 15%	\$1.18	15.0%	1.27

System Cost per Watt: \$3.18

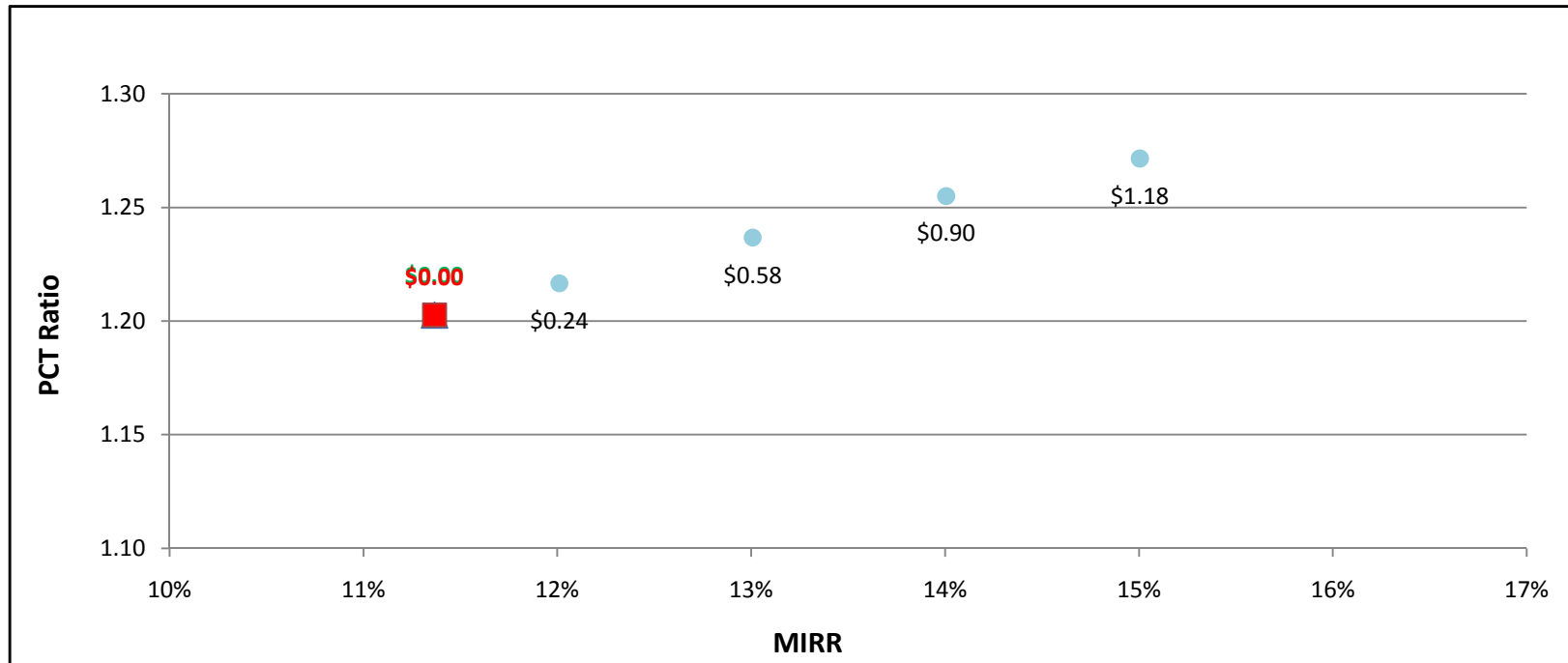

SGIP Cost Effectiveness Report
Participant Test Results (PCT)
MIRR Graphs

MT200kW w/ Natural Gas - Government/Non-Profit - SDG&E

	Rebate	MIRR	PCT-2010
▲ Actual Rebate - 2010	\$0.00	-4.5%	0.94
■ No Rebate	\$0.00	-4.5%	0.94
● Rebate to Reach MIRR of 10%	\$1.99	10.0%	1.05
● Rebate to Reach MIRR of 11%	\$2.12	11.0%	1.06
● Rebate to Reach MIRR of 12%	\$2.24	12.0%	1.07
● Rebate to Reach MIRR of 13%	\$2.35	13.0%	1.07
● Rebate to Reach MIRR of 14%	\$2.45	14.0%	1.08
● Rebate to Reach MIRR of 15%	\$2.55	15.1%	1.08

System Cost per Watt: \$3.18

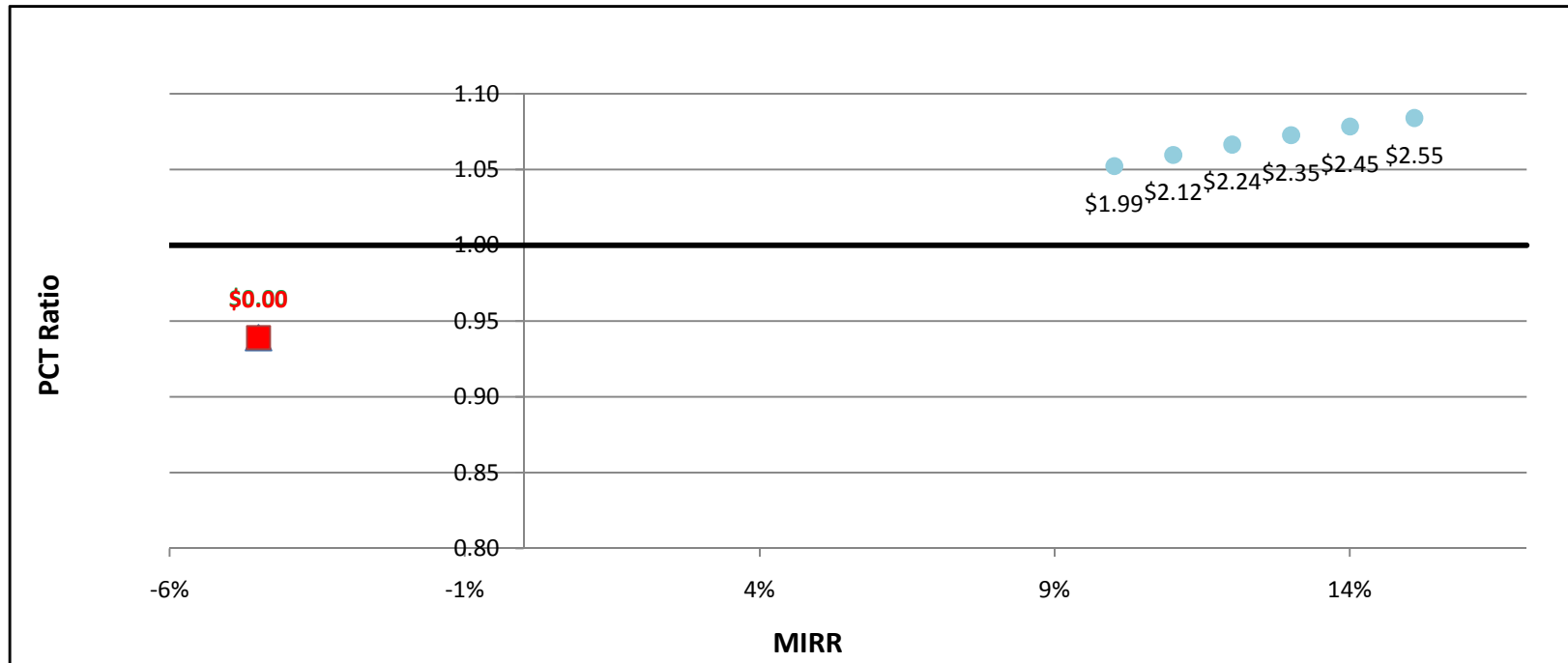

SGIP Cost Effectiveness Report
Participant Test Results (PCT)
MIRR Graphs

MT200kW w/ On-Site BioGas - Government/Non-Profit - PG&E

	Rebate	MIRR	PCT-2010
▲ Actual Rebate - 2010	\$0.00	0.0%	0.89
■ No Rebate	\$0.00	0.0%	0.89
● Rebate to Reach MIRR of 10%	\$7.87	10.0%	1.19
● Rebate to Reach MIRR of 11%	\$8.56	11.0%	1.22
● Rebate to Reach MIRR of 12%	\$9.20	12.1%	1.25
● Rebate to Reach MIRR of 13%	\$9.75	13.0%	1.27
● Rebate to Reach MIRR of 14%	\$0.00	0.0%	0.00
● Rebate to Reach MIRR of 15%	\$0.00	0.0%	0.00

System Cost per Watt: \$9.87

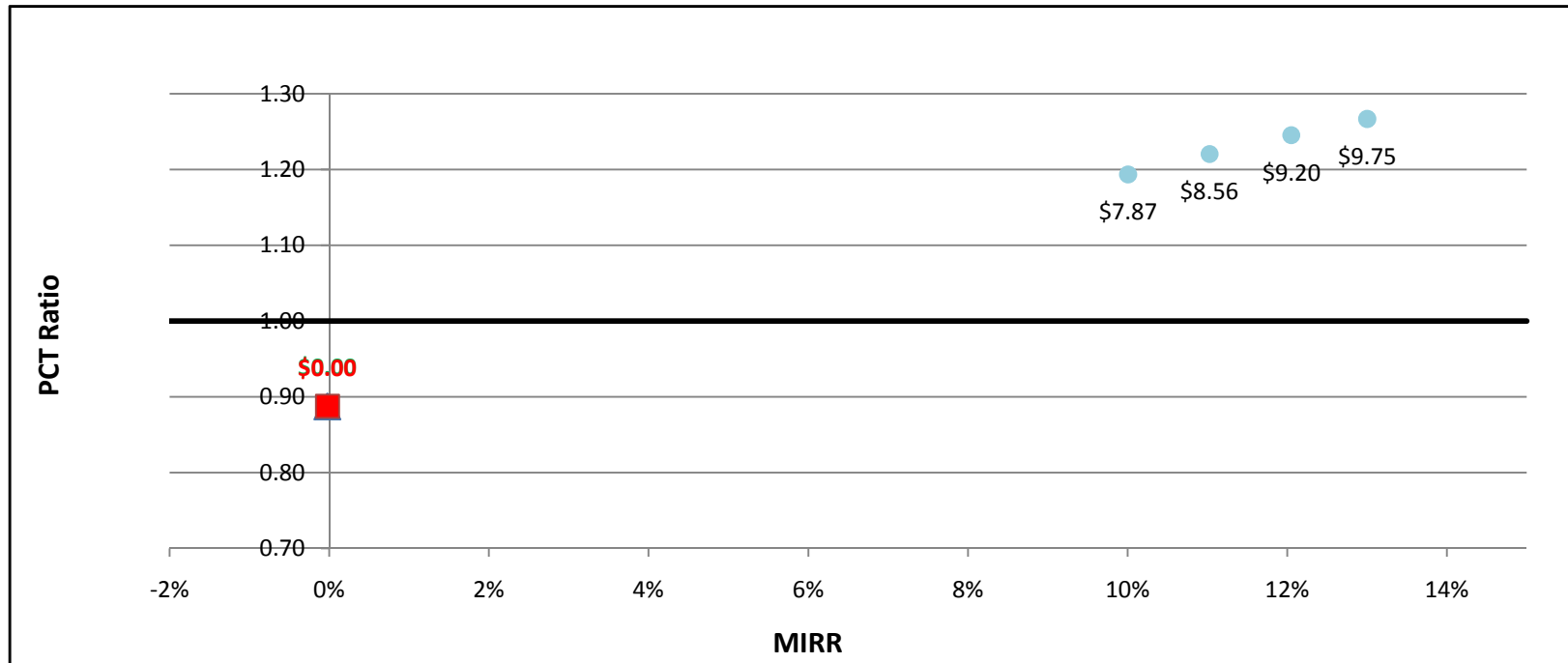

SGIP Cost Effectiveness Report
Participant Test Results (PCT)
MIRR Graphs

MT200kW w/ On-Site BioGas - Government/Non-Profit - SCE

	Rebate	MIRR	PCT-2010
▲ Actual Rebate - 2010	\$0.00	0.2%	0.89
■ No Rebate	\$0.00	0.2%	0.89
● Rebate to Reach MIRR of 10%	\$7.79	10.0%	1.20
● Rebate to Reach MIRR of 11%	\$8.49	11.0%	1.22
● Rebate to Reach MIRR of 12%	\$9.15	12.1%	1.25
● Rebate to Reach MIRR of 13%	\$9.69	13.0%	1.27
● Rebate to Reach MIRR of 14%	\$0.00	0.0%	0.00
● Rebate to Reach MIRR of 15%	\$0.00	0.0%	0.00

System Cost per Watt: \$9.87

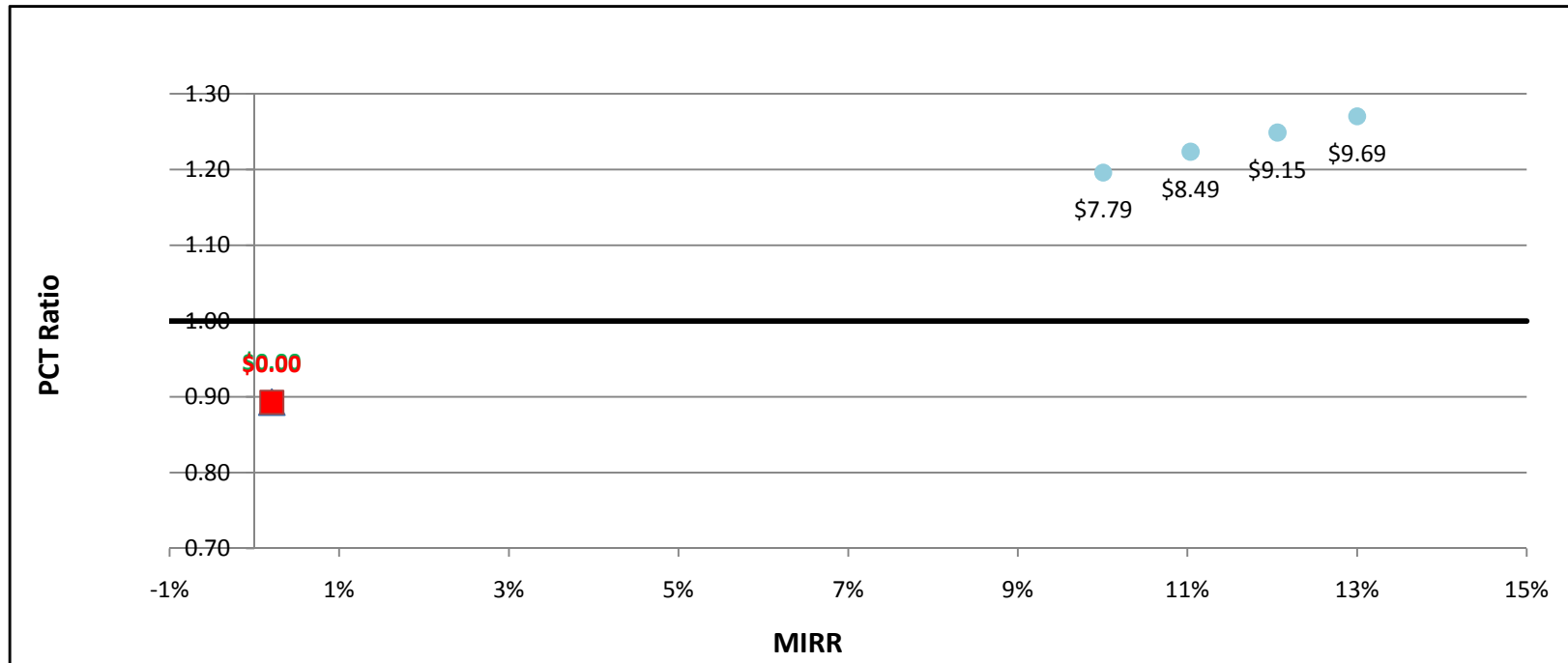

SGIP Cost Effectiveness Report
Participant Test Results (PCT)
MIRR Graphs

MT200kW w/ On-Site BioGas - Government/Non-Profit - SDG&E

	Rebate	MIRR	PCT-2010
▲ Actual Rebate - 2010	\$0.00	-6.7%	0.73
■ No Rebate	\$0.00	-6.7%	0.73
● Rebate to Reach MIRR of 10%	\$0.00	0.0%	0.00
● Rebate to Reach MIRR of 11%	\$0.00	0.0%	0.00
● Rebate to Reach MIRR of 12%	\$0.00	0.0%	0.00
● Rebate to Reach MIRR of 13%	\$0.00	0.0%	0.00
● Rebate to Reach MIRR of 14%	\$0.00	0.0%	0.00
● Rebate to Reach MIRR of 15%	\$0.00	0.0%	0.00

System Cost per Watt: \$9.87

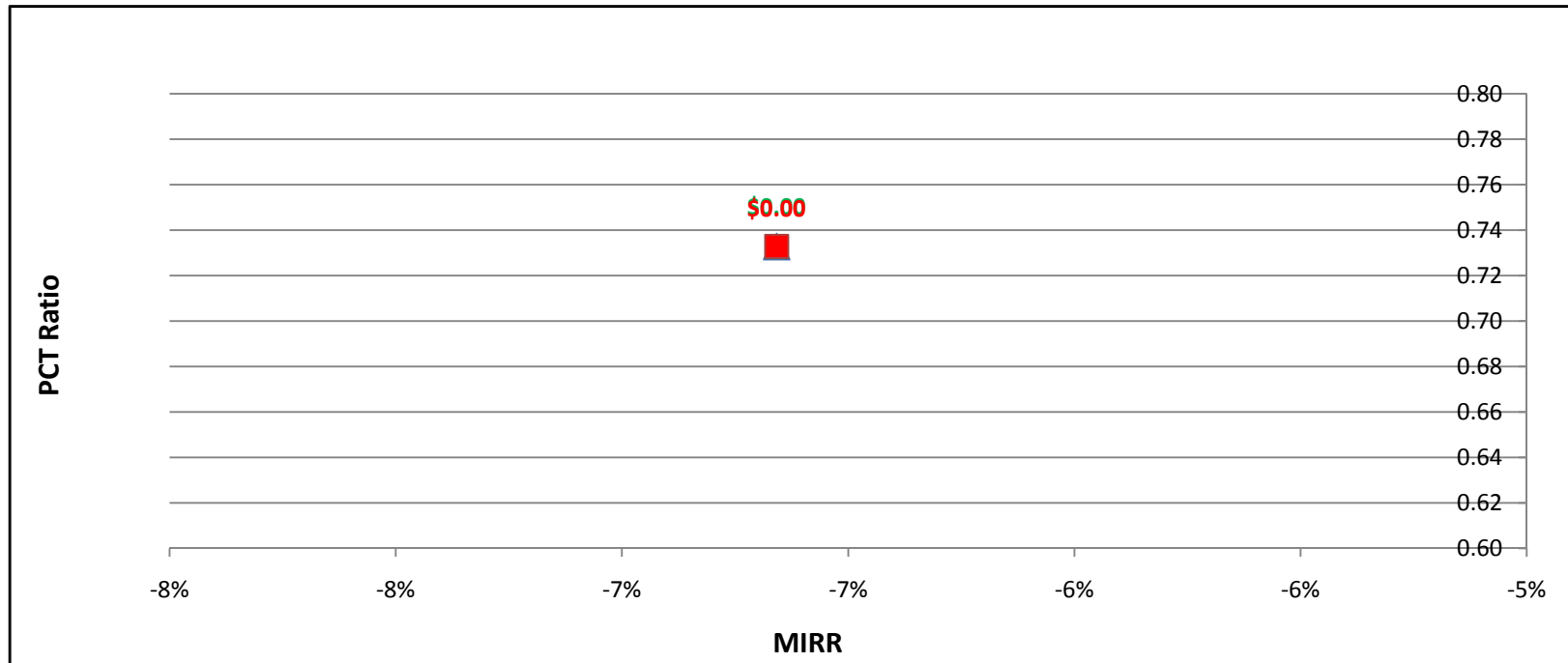

SGIP Cost Effectiveness Report
Participant Test Results (PCT)
MIRR Graphs

MT200kW w/ Directed BioGas - Commercial - PG&E

	Rebate	MIRR	PCT-2010
▲ Actual Rebate - 2010	\$0.00	0.9%	0.87
■ No Rebate	\$0.00	0.9%	0.87
● Rebate to Reach MIRR of 10%	\$0.00	0.0%	0.00
● Rebate to Reach MIRR of 11%	\$0.00	0.0%	0.00
● Rebate to Reach MIRR of 12%	\$0.00	0.0%	0.00
● Rebate to Reach MIRR of 13%	\$0.00	0.0%	0.00
● Rebate to Reach MIRR of 14%	\$0.00	0.0%	0.00
● Rebate to Reach MIRR of 15%	\$0.00	0.0%	0.00

System Cost per Watt: \$3.18

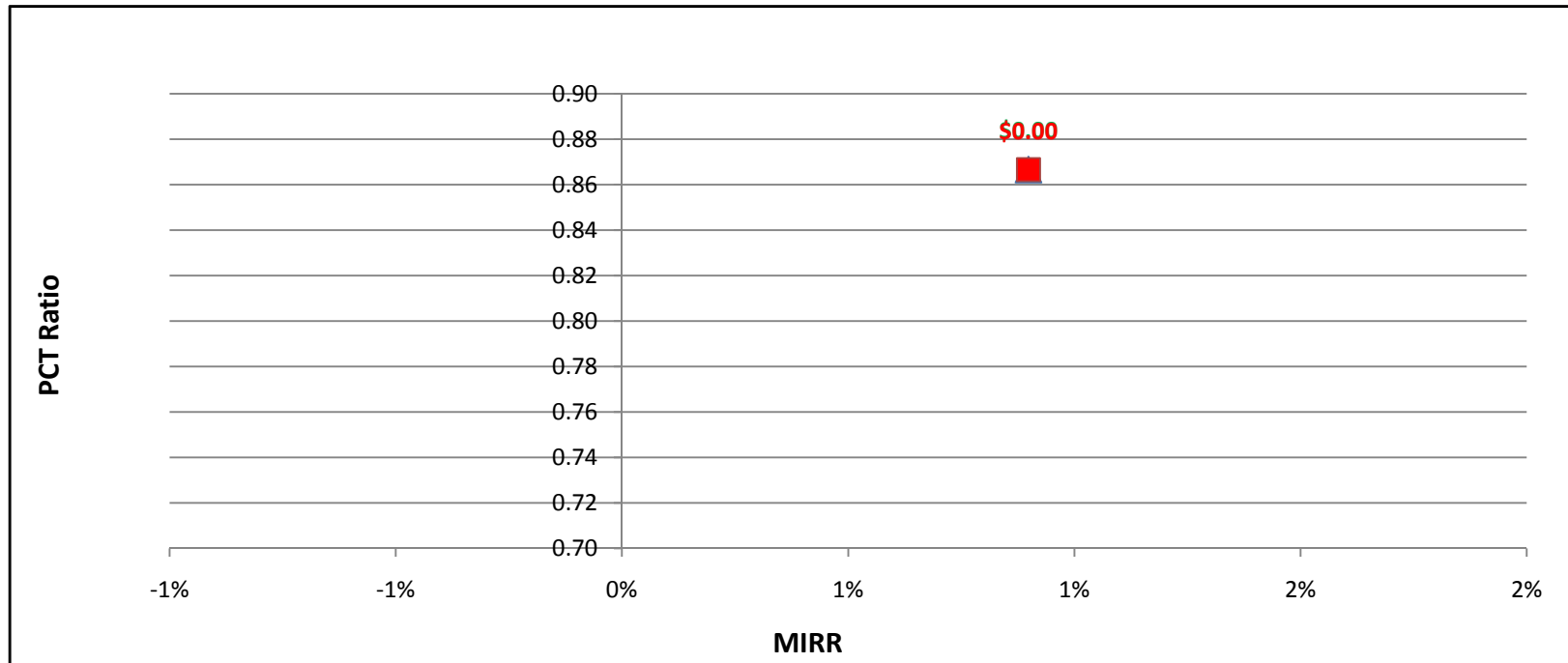

SGIP Cost Effectiveness Report
Participant Test Results (PCT)
MIRR Graphs

MT200kW w/ Directed BioGas - Commercial - SCE

	Rebate	MIRR	PCT-2010
▲ Actual Rebate - 2010	\$0.00	1.0%	0.87
■ No Rebate	\$0.00	1.0%	0.87
● Rebate to Reach MIRR of 10%	\$0.00	0.0%	0.00
● Rebate to Reach MIRR of 11%	\$0.00	0.0%	0.00
● Rebate to Reach MIRR of 12%	\$0.00	0.0%	0.00
● Rebate to Reach MIRR of 13%	\$0.00	0.0%	0.00
● Rebate to Reach MIRR of 14%	\$0.00	0.0%	0.00
● Rebate to Reach MIRR of 15%	\$0.00	0.0%	0.00

System Cost per Watt: \$3.18

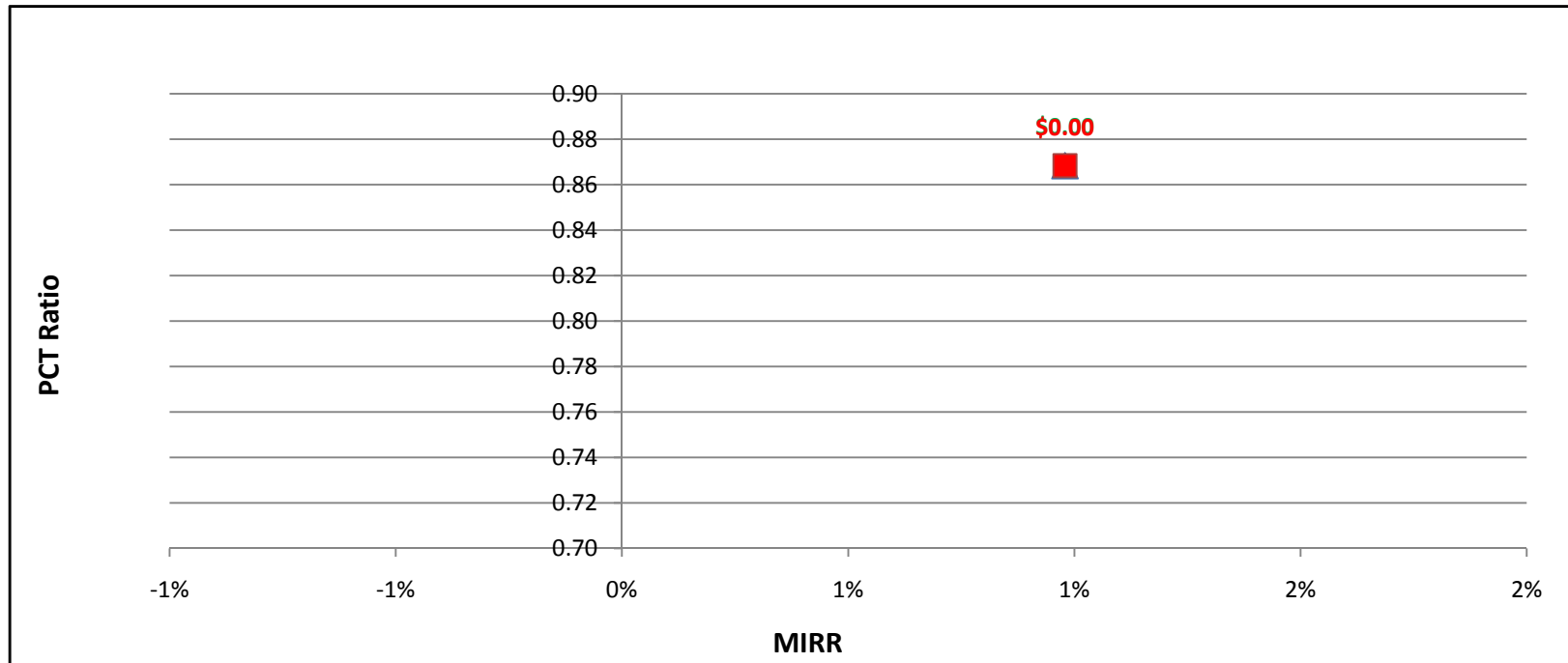

SGIP Cost Effectiveness Report
Participant Test Results (PCT)
MIRR Graphs

MT200kW w/ Directed BioGas - Commercial - SDG&E

	Rebate	MIRR	PCT-2010
▲ Actual Rebate - 2010	\$0.00	-5.8%	0.77
■ No Rebate	\$0.00	-5.8%	0.77
● Rebate to Reach MIRR of 10%	\$0.00	0.0%	0.00
● Rebate to Reach MIRR of 11%	\$0.00	0.0%	0.00
● Rebate to Reach MIRR of 12%	\$0.00	0.0%	0.00
● Rebate to Reach MIRR of 13%	\$0.00	0.0%	0.00
● Rebate to Reach MIRR of 14%	\$0.00	0.0%	0.00
● Rebate to Reach MIRR of 15%	\$0.00	0.0%	0.00

System Cost per Watt: \$3.18

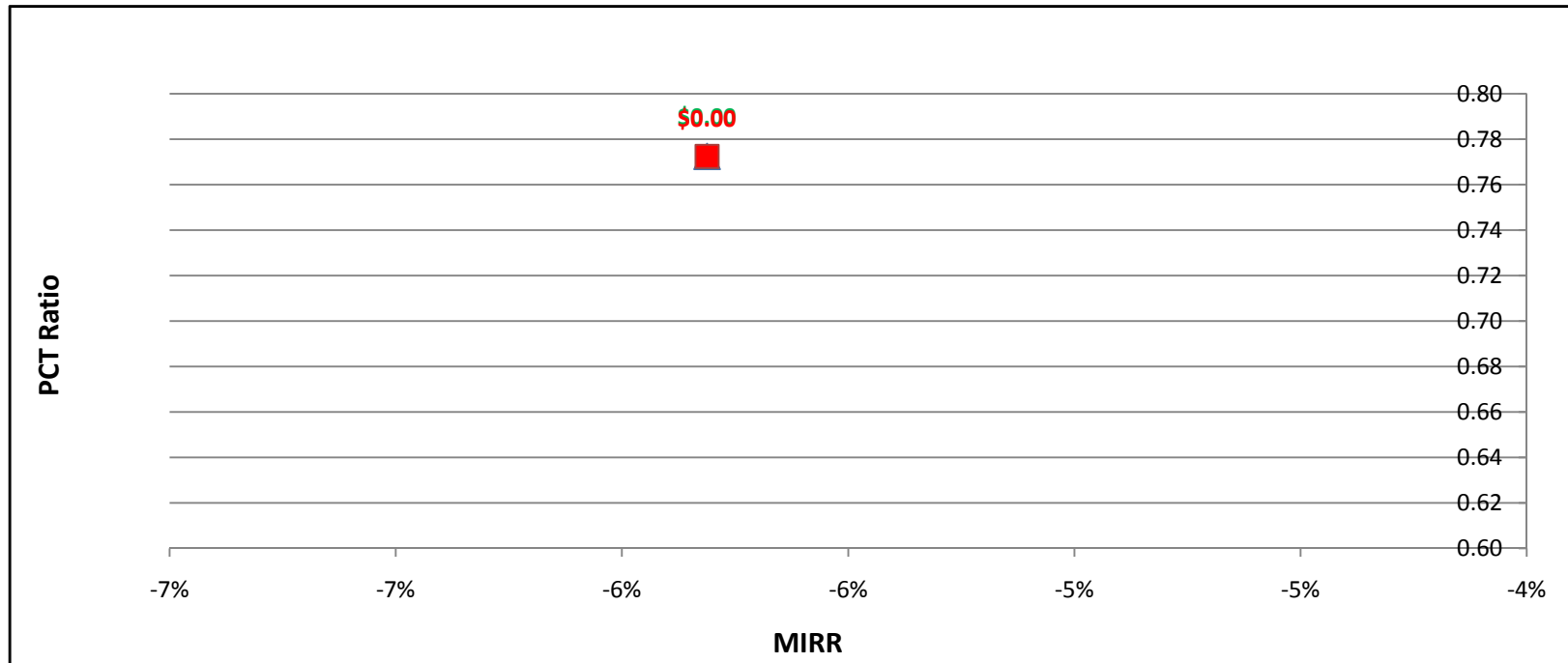

SGIP Cost Effectiveness Report
Participant Test Results (PCT)
MIRR Graphs

MT200kW w/ Natural Gas - Commercial - PG&E

	Rebate	MIRR	PCT-2010
▲ Actual Rebate - 2010	\$0.00	9.2%	0.98
■ No Rebate	\$0.00	9.2%	0.98
● Rebate to Reach MIRR of 10%	\$0.38	10.0%	1.00
● Rebate to Reach MIRR of 11%	\$0.92	11.0%	1.02
● Rebate to Reach MIRR of 12%	\$1.54	12.0%	1.05
● Rebate to Reach MIRR of 13%	\$2.24	12.9%	1.08
● Rebate to Reach MIRR of 14%	\$3.16	14.0%	1.13
● Rebate to Reach MIRR of 15%	\$0.00	0.0%	0.00

System Cost per Watt: \$3.18

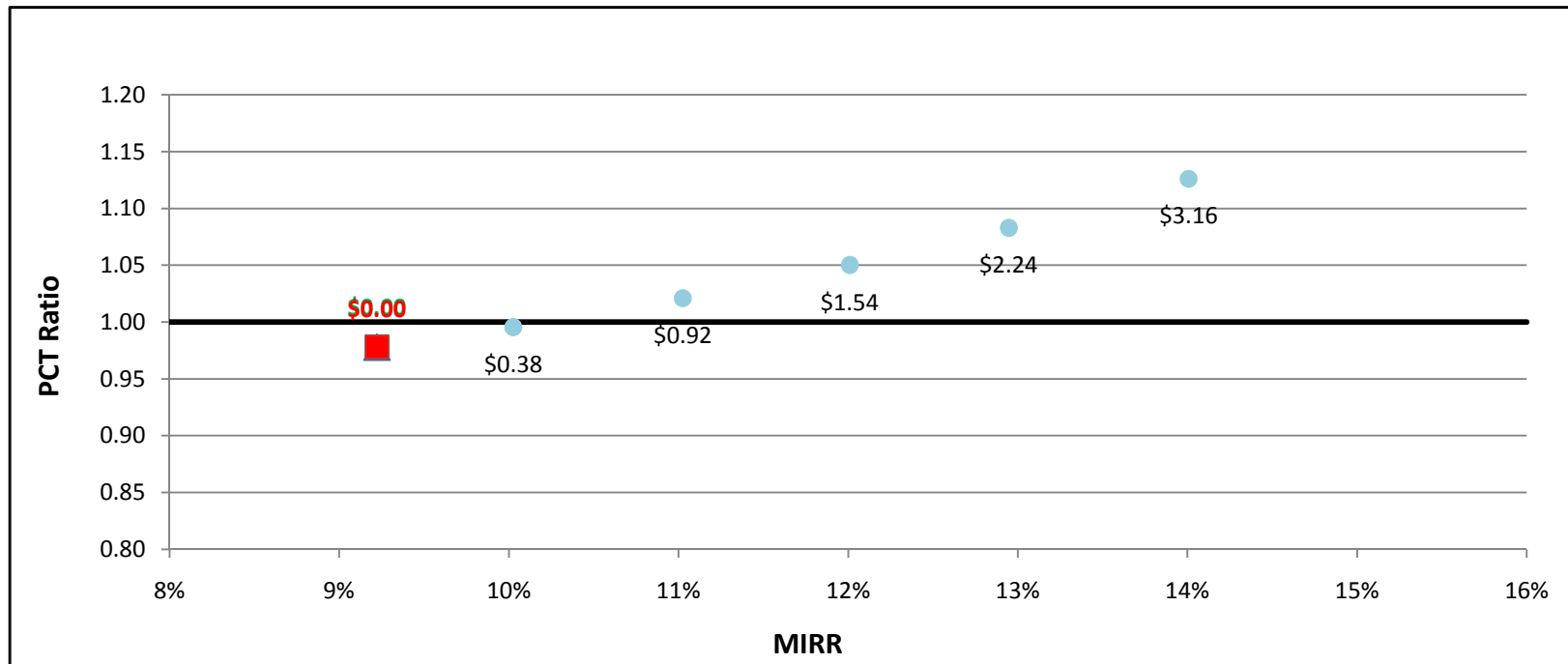

SGIP Cost Effectiveness Report
Participant Test Results (PCT)
MIRR Graphs

MT200kW w/ Natural Gas - Commercial - SCE

	Rebate	MIRR	PCT-2010
▲ Actual Rebate - 2010	\$0.00	9.3%	0.98
■ No Rebate	\$0.00	9.3%	0.98
● Rebate to Reach MIRR of 10%	\$0.35	10.0%	1.00
● Rebate to Reach MIRR of 11%	\$0.92	11.1%	1.02
● Rebate to Reach MIRR of 12%	\$1.52	12.0%	1.05
● Rebate to Reach MIRR of 13%	\$2.21	12.9%	1.08
● Rebate to Reach MIRR of 14%	\$3.16	14.0%	1.13
● Rebate to Reach MIRR of 15%	\$0.00	0.0%	0.00

System Cost per Watt: \$3.18

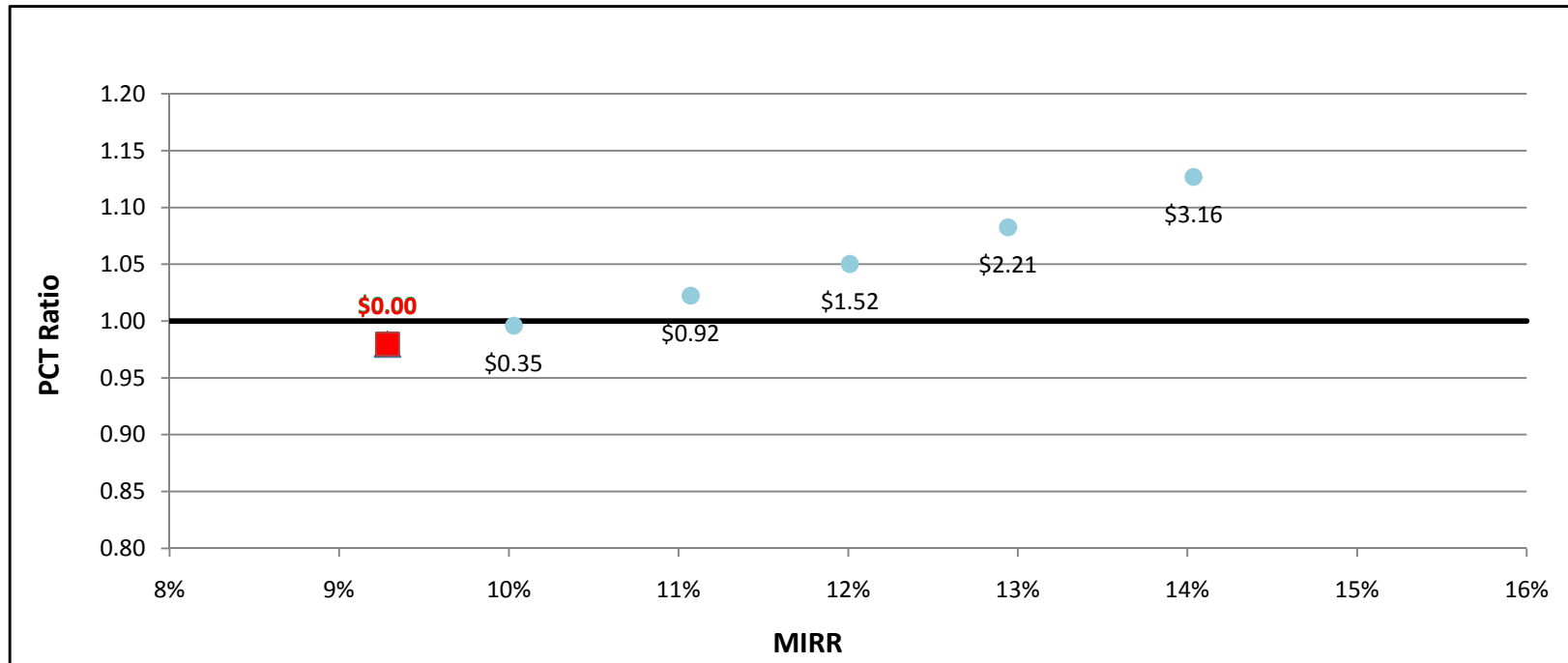

SGIP Cost Effectiveness Report
 Participant Test Results (PCT)
 MIRR Graphs

MT200kW w/ Natural Gas - Commercial - SDG&E

	Rebate	MIRR	PCT-2010
▲ Actual Rebate - 2010	\$0.00	3.1%	0.84
■ No Rebate	\$0.00	3.1%	0.84
● Rebate to Reach MIRR of 10%	\$2.96	10.0%	0.98
● Rebate to Reach MIRR of 11%	\$0.00	0.0%	0.00
● Rebate to Reach MIRR of 12%	\$0.00	0.0%	0.00
● Rebate to Reach MIRR of 13%	\$0.00	0.0%	0.00
● Rebate to Reach MIRR of 14%	\$0.00	0.0%	0.00
● Rebate to Reach MIRR of 15%	\$0.00	0.0%	0.00

System Cost per Watt: \$3.18

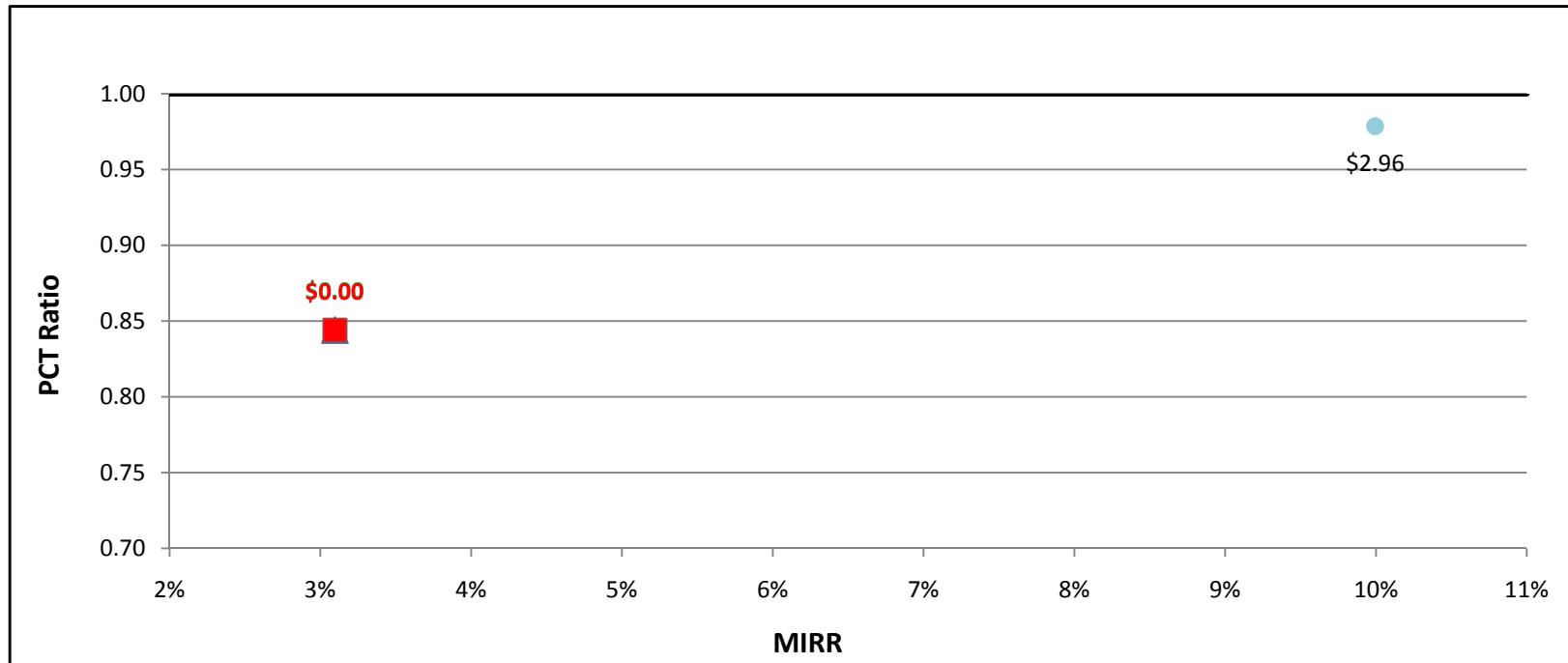

SGIP Cost Effectiveness Report
 Participant Test Results (PCT)
 MIRR Graphs

MT200kW w/ On-Site BioGas - Commercial - PG&E

	Rebate	MIRR	PCT-2010
▲ Actual Rebate - 2010	\$0.00	7.0%	0.82
■ No Rebate	\$0.00	7.0%	0.82
● Rebate to Reach MIRR of 10%	\$5.51	9.9%	0.97
● Rebate to Reach MIRR of 11%	\$8.18	11.0%	1.04
● Rebate to Reach MIRR of 12%	\$0.00	0.0%	0.00
● Rebate to Reach MIRR of 13%	\$0.00	0.0%	0.00
● Rebate to Reach MIRR of 14%	\$0.00	0.0%	0.00
● Rebate to Reach MIRR of 15%	\$0.00	0.0%	0.00

System Cost per Watt: \$9.87

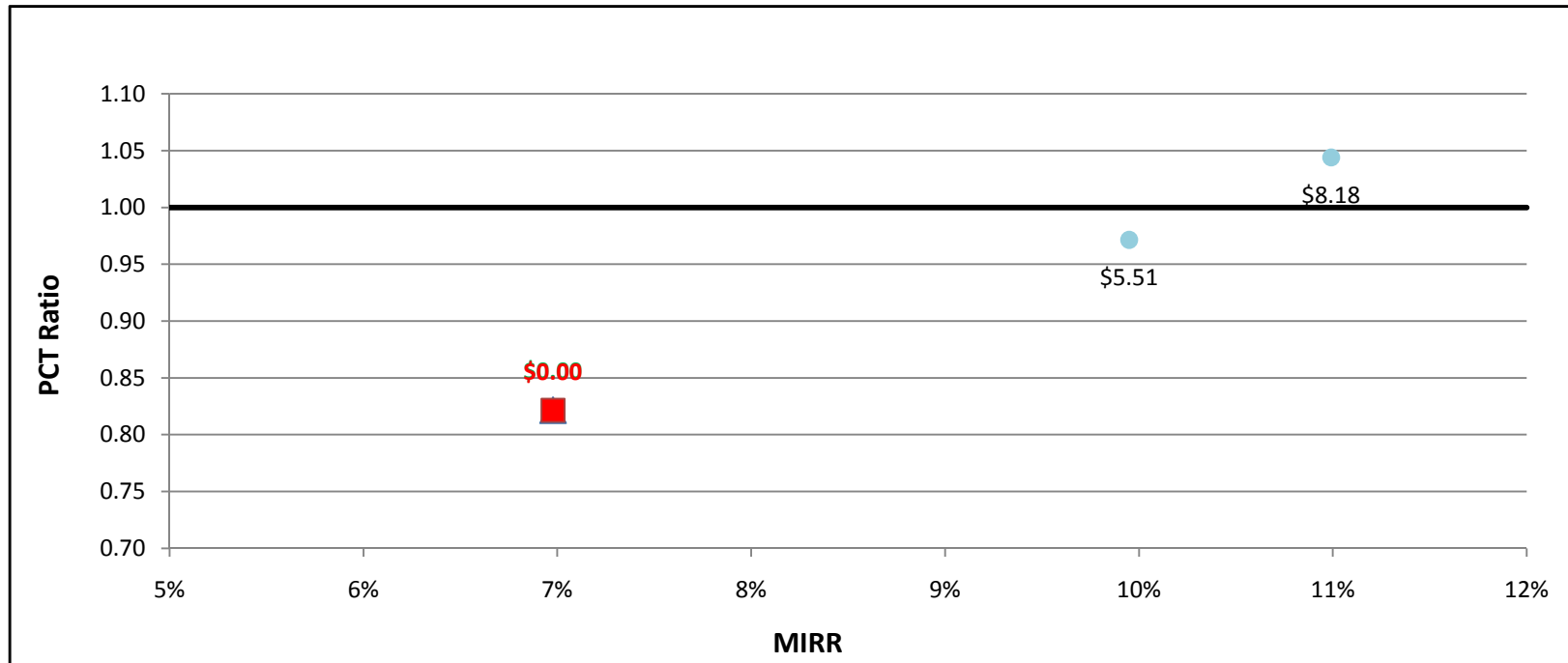

SGIP Cost Effectiveness Report
 Participant Test Results (PCT)
 MIRR Graphs

MT200kW w/ On-Site BioGas - Commercial - SCE

	Rebate	MIRR	PCT-2010
▲ Actual Rebate - 2010	\$0.00	7.0%	0.82
■ No Rebate	\$0.00	7.0%	0.82
● Rebate to Reach MIRR of 10%	\$5.40	9.9%	0.97
● Rebate to Reach MIRR of 11%	\$8.07	11.0%	1.04
● Rebate to Reach MIRR of 12%	\$0.00	0.0%	0.00
● Rebate to Reach MIRR of 13%	\$0.00	0.0%	0.00
● Rebate to Reach MIRR of 14%	\$0.00	0.0%	0.00
● Rebate to Reach MIRR of 15%	\$0.00	0.0%	0.00

System Cost per Watt: \$9.87

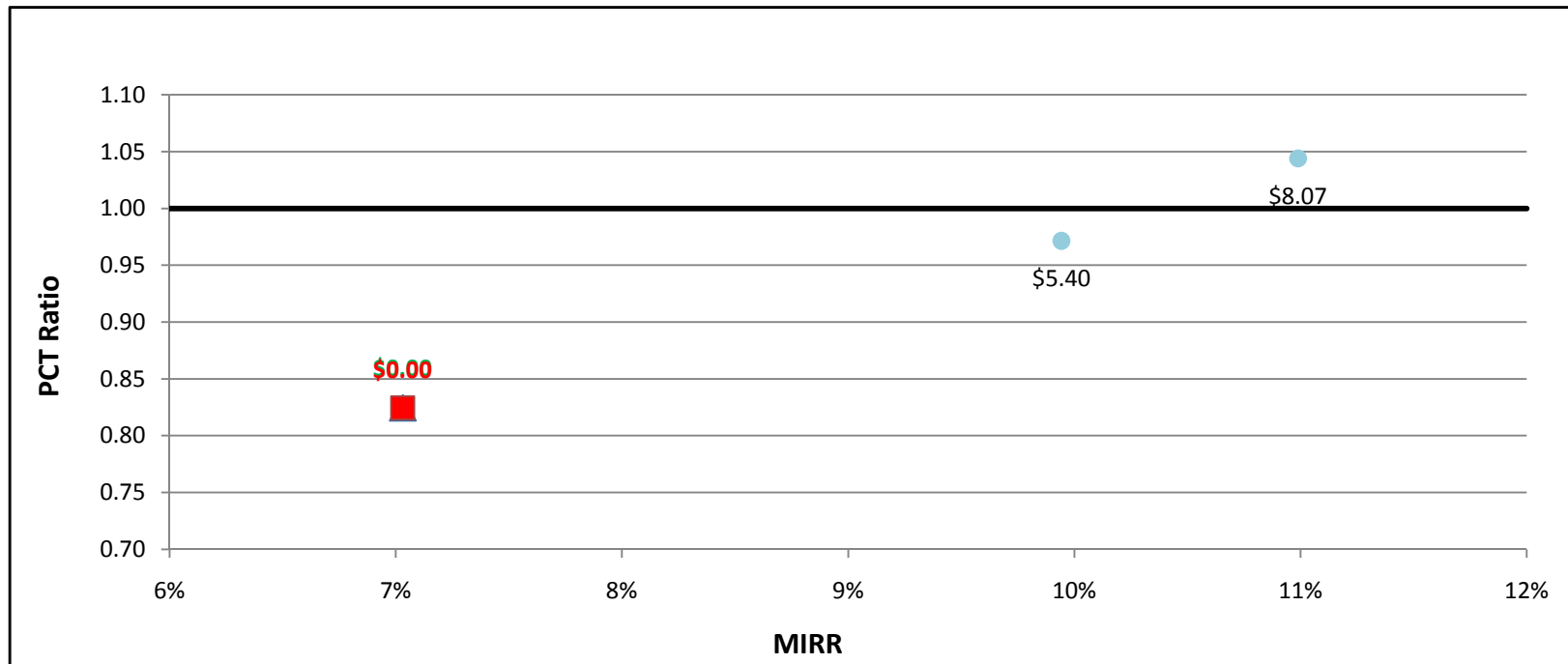

SGIP Cost Effectiveness Report
Participant Test Results (PCT)
MIRR Graphs

MT200kW w/ On-Site BioGas - Commercial - SDG&E

	Rebate	MIRR	PCT-2010
▲ Actual Rebate - 2010	\$0.00	5.7%	0.75
■ No Rebate	\$0.00	5.7%	0.75
● Rebate to Reach MIRR of 10%	\$7.84	10.0%	0.96
● Rebate to Reach MIRR of 11%	\$0.00	0.0%	0.00
● Rebate to Reach MIRR of 12%	\$0.00	0.0%	0.00
● Rebate to Reach MIRR of 13%	\$0.00	0.0%	0.00
● Rebate to Reach MIRR of 14%	\$0.00	0.0%	0.00
● Rebate to Reach MIRR of 15%	\$0.00	0.0%	0.00

System Cost per Watt: \$9.87

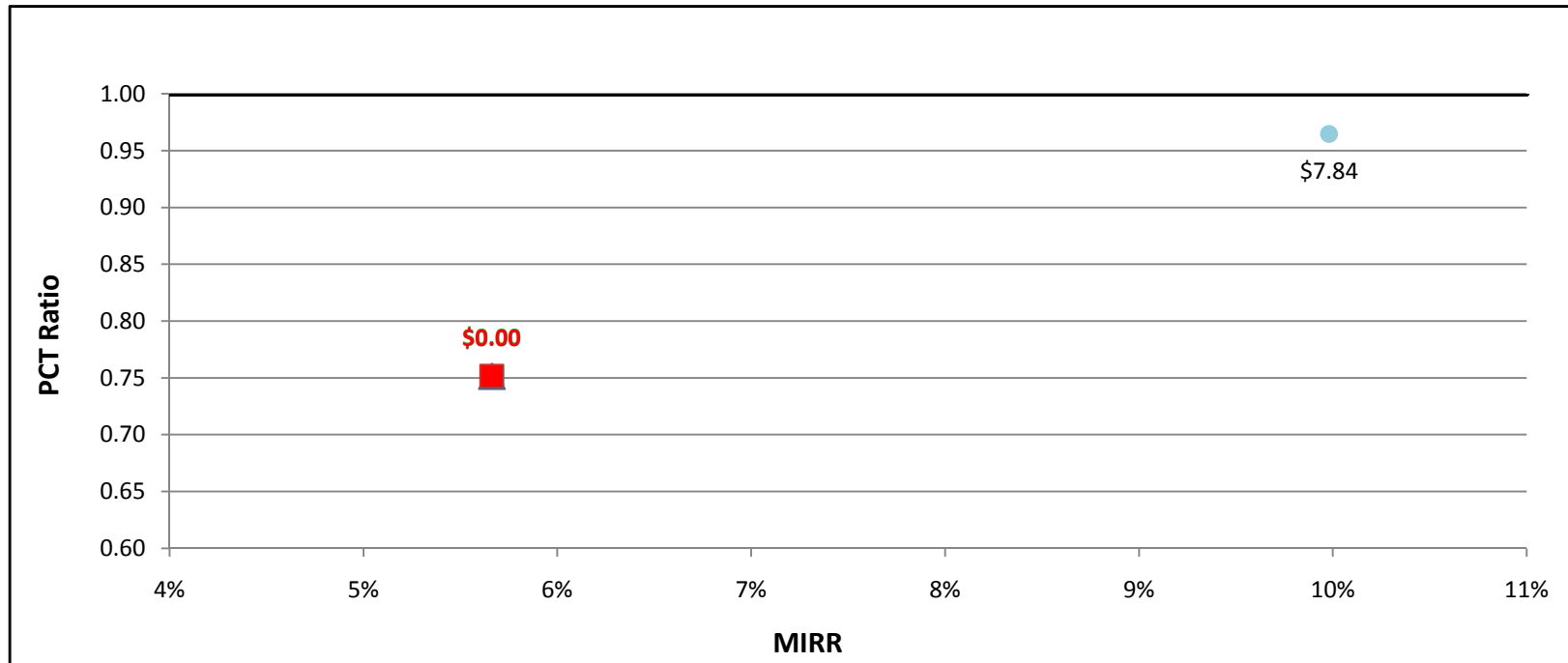

SGIP Cost Effectiveness Report
Participant Test Results (PCT)
MIRR Graphs

ORC500kW - Government/Non-Profit - PG&E

	Rebate	MIRR	PCT-2010
▲ Actual Rebate - 2010	\$0.00	10.0%	1.67
■ No Rebate	\$0.00	10.0%	1.67
● Rebate to Reach MIRR of 10%	\$0.06	10.1%	1.68
● Rebate to Reach MIRR of 11%	\$0.69	11.0%	1.77
● Rebate to Reach MIRR of 12%	\$1.27	12.0%	1.85
● Rebate to Reach MIRR of 13%	\$1.81	13.0%	1.93
● Rebate to Reach MIRR of 14%	\$2.30	14.0%	2.00
● Rebate to Reach MIRR of 15%	\$2.74	15.0%	2.06

System Cost per Watt: \$5.88

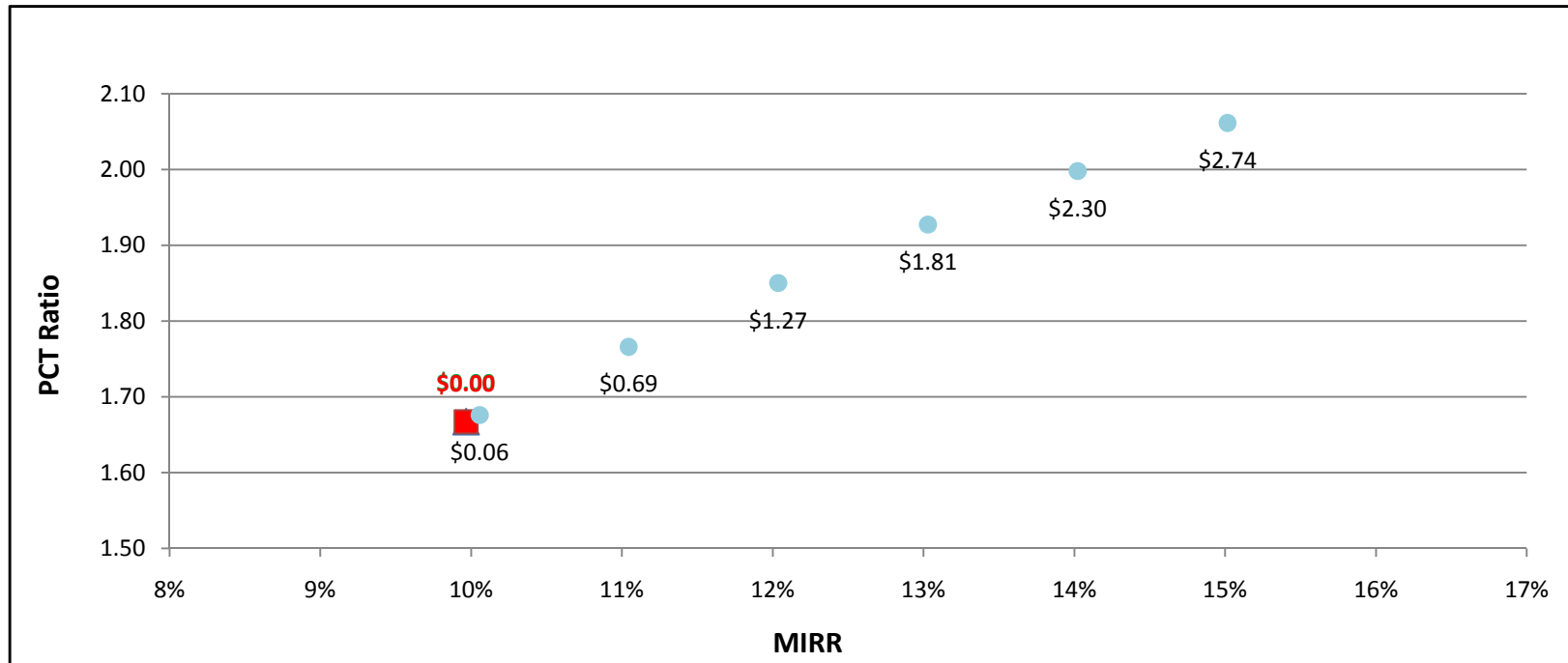

SGIP Cost Effectiveness Report
Participant Test Results (PCT)
MIRR Graphs

ORC500kW - Government/Non-Profit - SCE

	Rebate	MIRR	PCT-2010
▲ Actual Rebate - 2010	\$0.00	9.9%	1.66
■ No Rebate	\$0.00	9.9%	1.66
● Rebate to Reach MIRR of 10%	\$0.09	10.1%	1.67
● Rebate to Reach MIRR of 11%	\$0.72	11.0%	1.76
● Rebate to Reach MIRR of 12%	\$1.30	12.0%	1.85
● Rebate to Reach MIRR of 13%	\$1.83	13.0%	1.92
● Rebate to Reach MIRR of 14%	\$2.32	14.0%	1.99
● Rebate to Reach MIRR of 15%	\$2.76	15.0%	2.06

System Cost per Watt: \$5.88

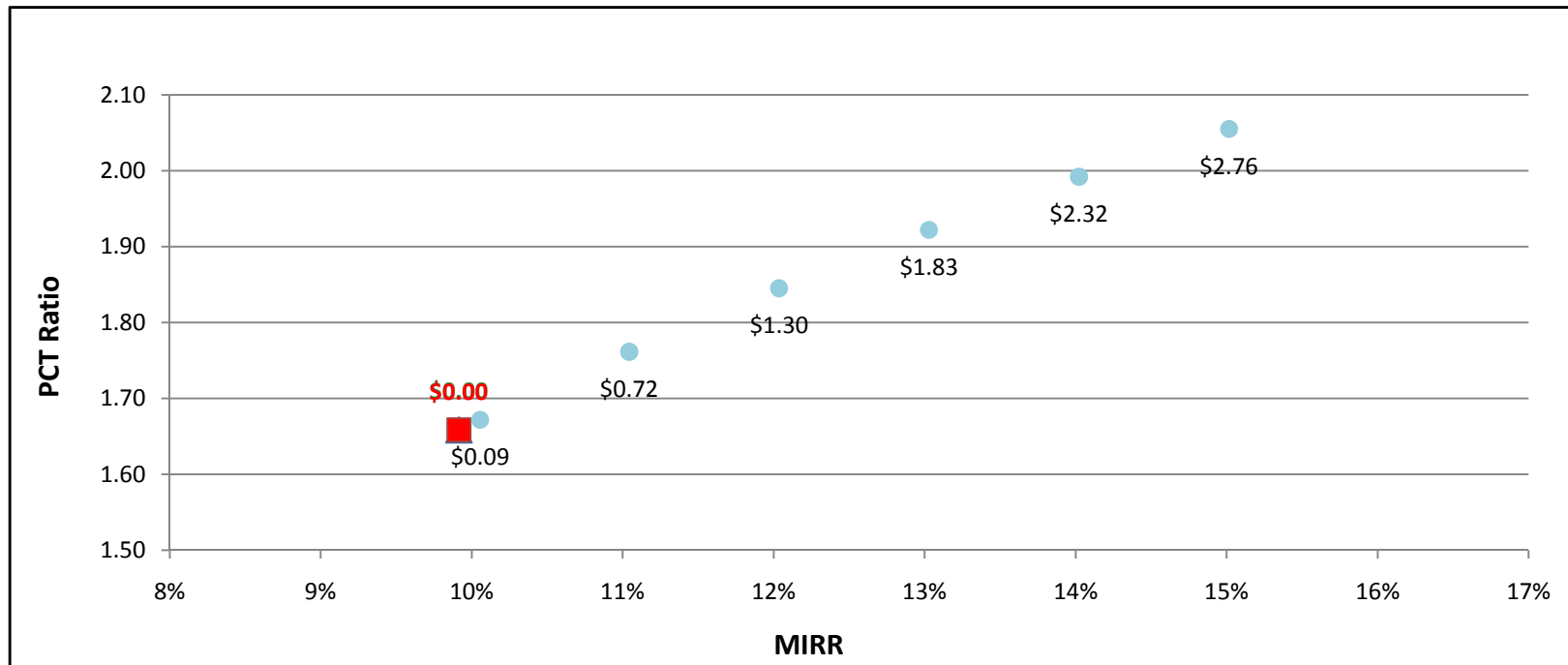

SGIP Cost Effectiveness Report
Participant Test Results (PCT)
MIRR Graphs

ORC500kW - Government/Non-Profit - SDG&E

	Rebate	MIRR	PCT-2010
▲ Actual Rebate - 2010	\$0.00	6.3%	1.20
■ No Rebate	\$0.00	6.3%	1.20
● Rebate to Reach MIRR of 10%	\$1.84	10.0%	1.46
● Rebate to Reach MIRR of 11%	\$2.28	11.0%	1.53
● Rebate to Reach MIRR of 12%	\$2.68	12.0%	1.59
● Rebate to Reach MIRR of 13%	\$3.06	13.0%	1.64
● Rebate to Reach MIRR of 14%	\$3.40	14.0%	1.69
● Rebate to Reach MIRR of 15%	\$3.73	15.1%	1.74

System Cost per Watt: \$5.88

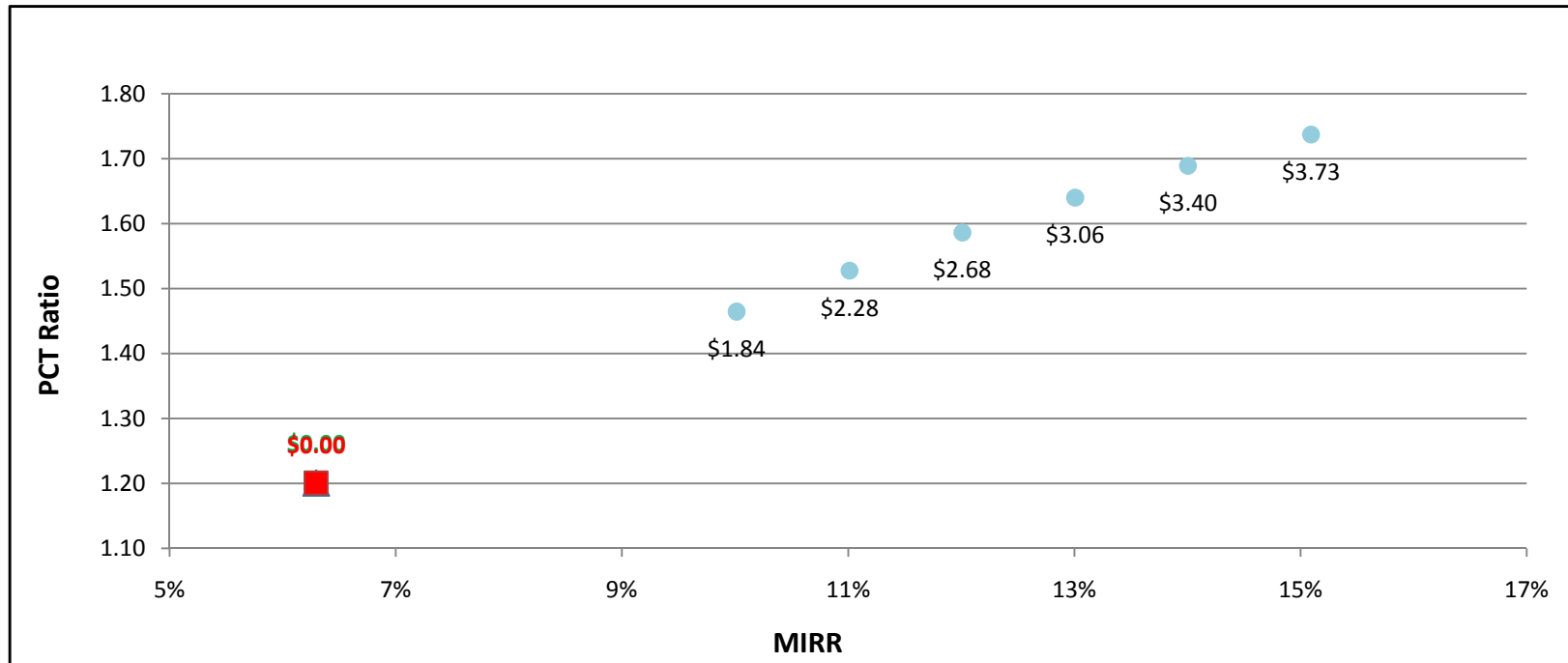

SGIP Cost Effectiveness Report
Participant Test Results (PCT)
MIRR Graphs

ORC500kW - Commercial - PG&E

	Rebate	MIRR	PCT-2010
▲ Actual Rebate - 2010	\$0.00	11.8%	1.22
■ No Rebate	\$0.00	11.8%	1.22
● Rebate to Reach MIRR of 10%	\$0.00	0.0%	0.00
● Rebate to Reach MIRR of 11%	\$0.00	0.0%	0.00
● Rebate to Reach MIRR of 12%	\$0.26	12.0%	1.24
● Rebate to Reach MIRR of 13%	\$1.70	13.1%	1.37
● Rebate to Reach MIRR of 14%	\$3.15	14.0%	1.50
● Rebate to Reach MIRR of 15%	\$5.22	15.1%	1.69

System Cost per Watt: \$5.88

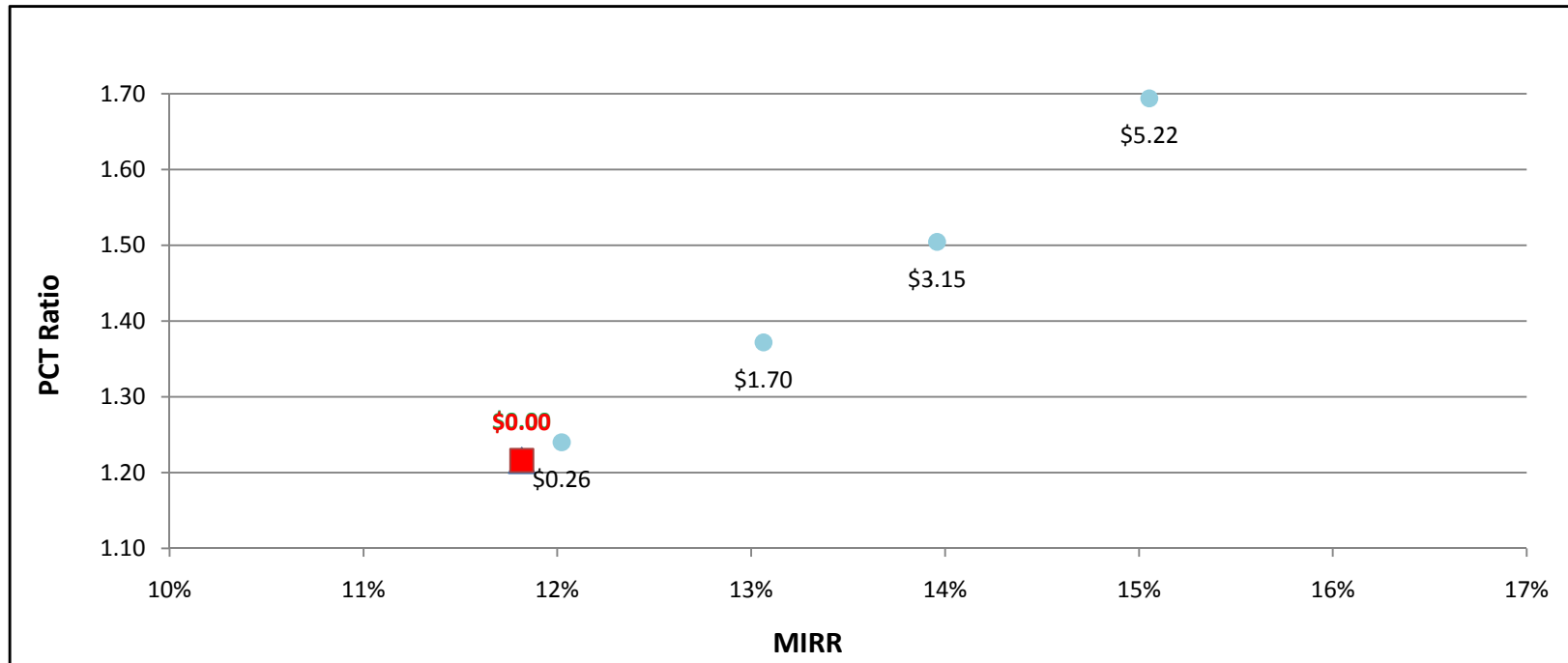

SGIP Cost Effectiveness Report
Participant Test Results (PCT)
MIRR Graphs

ORC500kW - Commercial - SCE

	Rebate	MIRR	PCT-2010
▲ Actual Rebate - 2010	\$0.00	11.8%	1.21
■ No Rebate	\$0.00	11.8%	1.21
● Rebate to Reach MIRR of 10%	\$0.00	0.0%	0.00
● Rebate to Reach MIRR of 11%	\$0.00	0.0%	0.00
● Rebate to Reach MIRR of 12%	\$0.29	12.0%	1.24
● Rebate to Reach MIRR of 13%	\$1.70	13.0%	1.37
● Rebate to Reach MIRR of 14%	\$3.19	14.0%	1.50
● Rebate to Reach MIRR of 15%	\$5.22	15.0%	1.69

System Cost per Watt: \$5.88

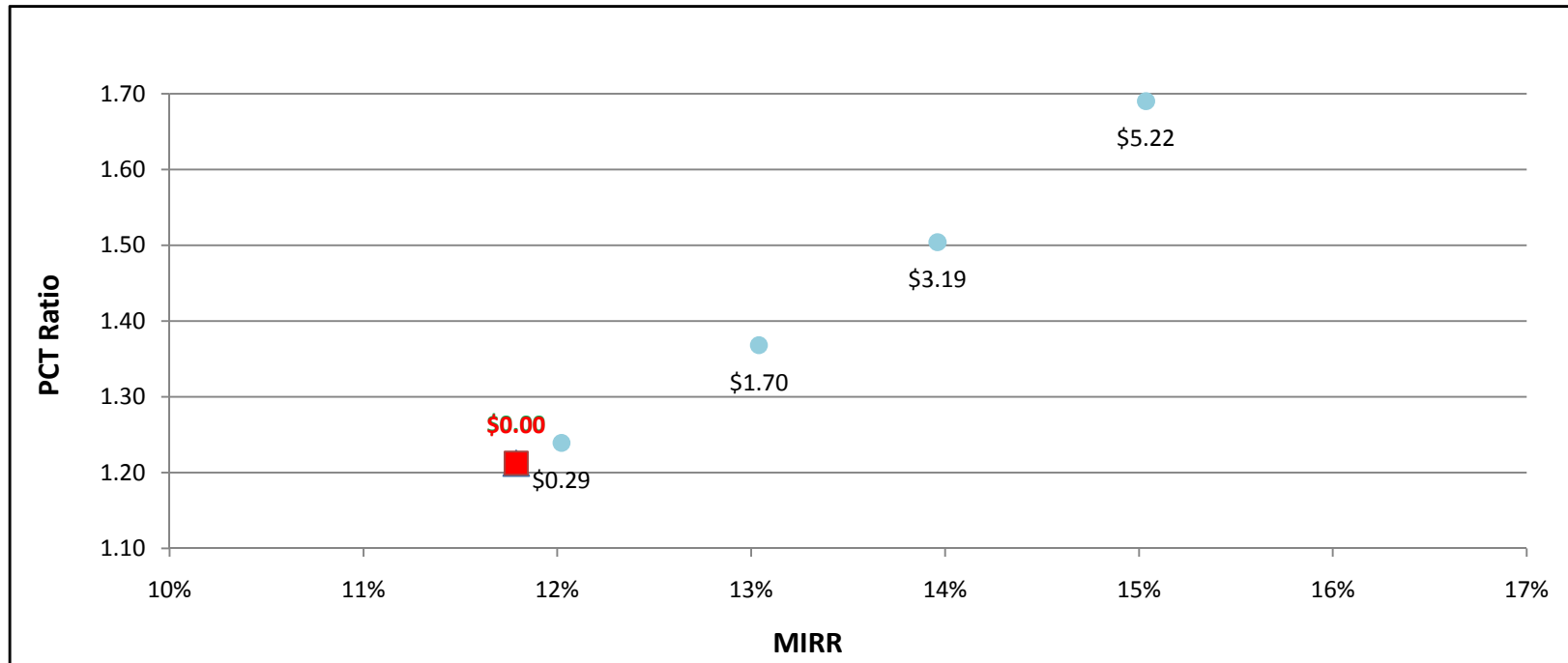

SGIP Cost Effectiveness Report
Participant Test Results (PCT)
MIRR Graphs

ORC500kW - Commercial - SDG&E

	Rebate	MIRR	PCT-2010
▲ Actual Rebate - 2010	\$0.00	10.1%	1.01
■ No Rebate	\$0.00	10.1%	1.01
● Rebate to Reach MIRR of 10%	\$0.00	10.1%	1.01
● Rebate to Reach MIRR of 11%	\$0.92	11.0%	1.10
● Rebate to Reach MIRR of 12%	\$2.12	12.0%	1.21
● Rebate to Reach MIRR of 13%	\$3.41	13.0%	1.32
● Rebate to Reach MIRR of 14%	\$5.22	14.1%	1.49
● Rebate to Reach MIRR of 15%	\$0.00	0.0%	0.00

System Cost per Watt: \$5.88

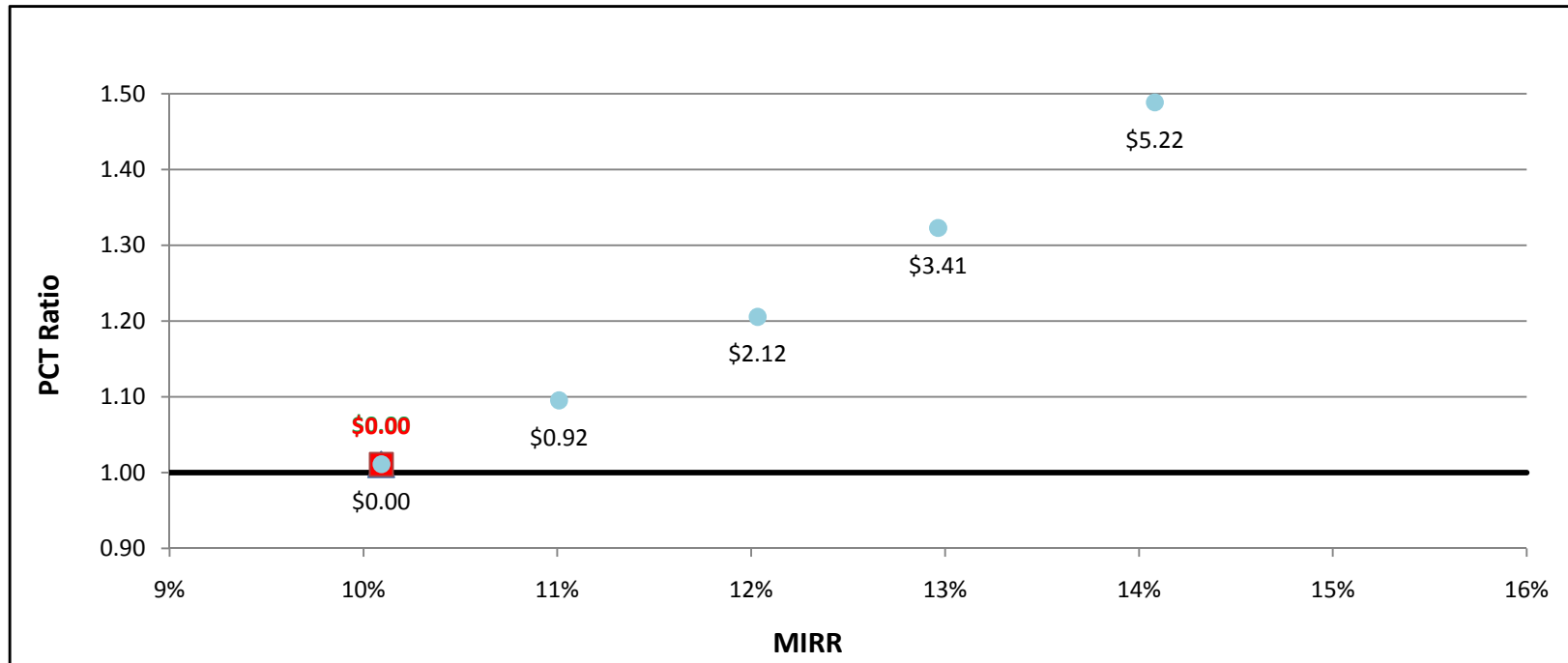

SGIP Cost Effectiveness Report
Participant Test Results (PCT)
MIRR Graphs

Storage1MW - Government/Non-Profit - PG&E

	Rebate	MIRR	PCT-2010
▲ Actual Rebate - 2010	\$2.00	-100.0%	0.59
■ No Rebate	\$0.00	-100.0%	0.33
● Rebate to Reach MIRR of 10%	\$0.00	0.0%	0.00
● Rebate to Reach MIRR of 11%	\$0.00	0.0%	0.00
● Rebate to Reach MIRR of 12%	\$0.00	0.0%	0.00
● Rebate to Reach MIRR of 13%	\$0.00	0.0%	0.00
● Rebate to Reach MIRR of 14%	\$0.00	0.0%	0.00
● Rebate to Reach MIRR of 15%	\$0.00	0.0%	0.00

System Cost per Watt: \$3.90

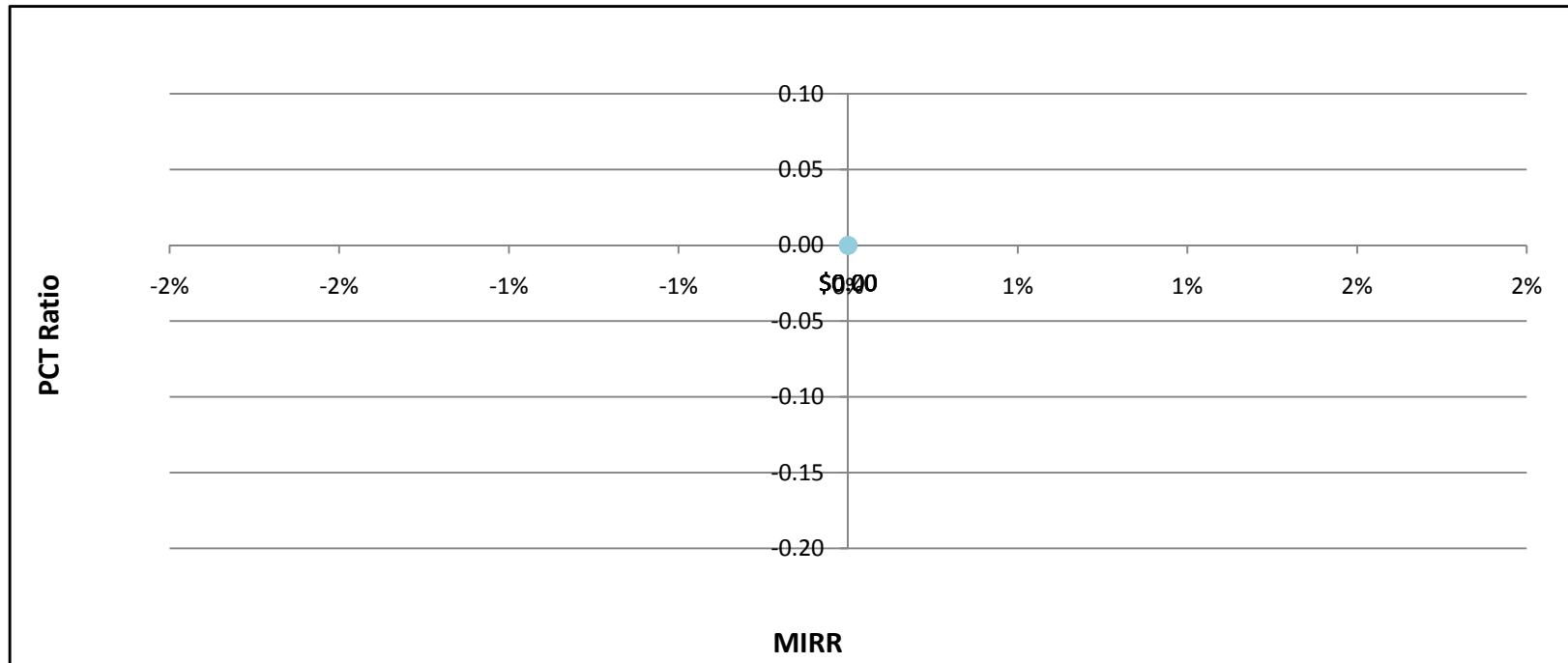

SGIP Cost Effectiveness Report
 Participant Test Results (PCT)
 MIRR Graphs

Storage1MW - Government/Non-Profit - SCE

	Rebate	MIRR	PCT-2010
▲ Actual Rebate - 2010	\$2.00	-100.0%	0.59
■ No Rebate	\$0.00	-100.0%	0.31
● Rebate to Reach MIRR of 10%	\$0.00	0.0%	0.00
● Rebate to Reach MIRR of 11%	\$0.00	0.0%	0.00
● Rebate to Reach MIRR of 12%	\$0.00	0.0%	0.00
● Rebate to Reach MIRR of 13%	\$0.00	0.0%	0.00
● Rebate to Reach MIRR of 14%	\$0.00	0.0%	0.00
● Rebate to Reach MIRR of 15%	\$0.00	0.0%	0.00

System Cost per Watt: \$3.90

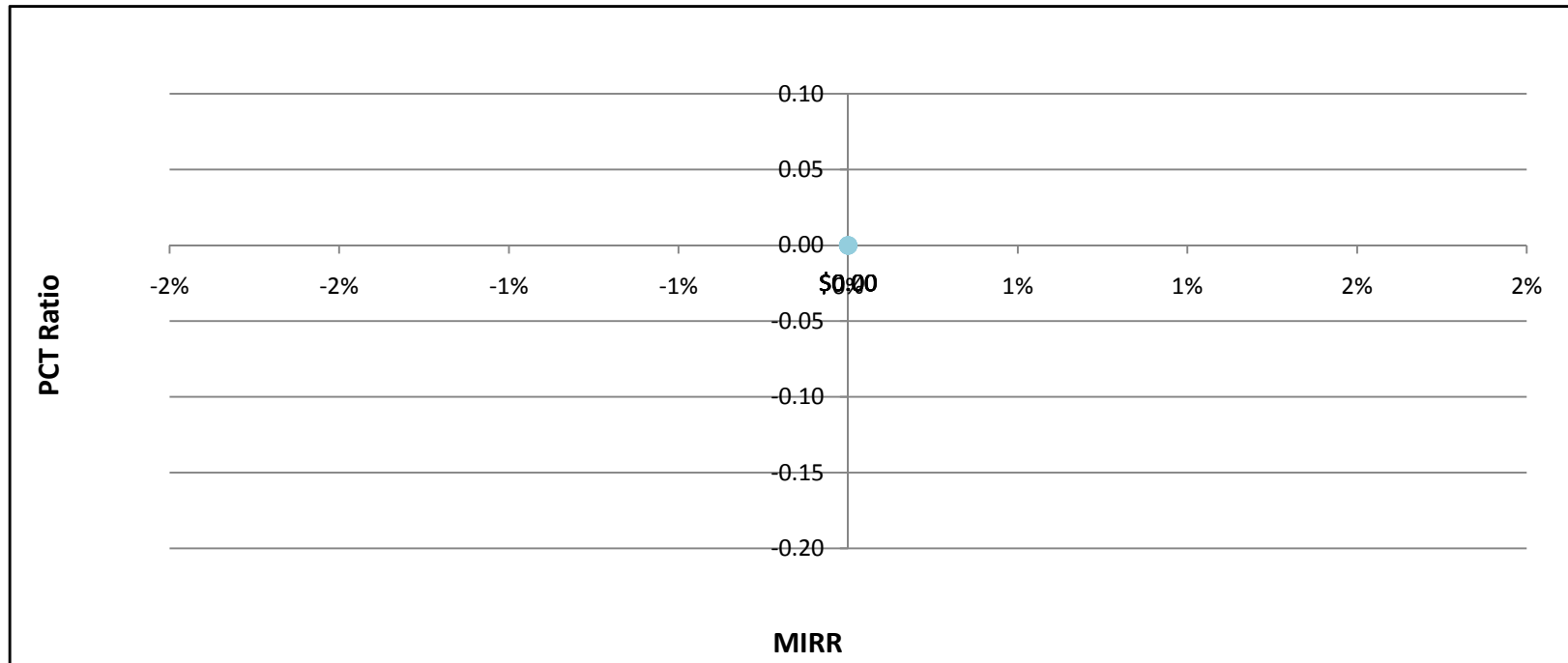

SGIP Cost Effectiveness Report
Participant Test Results (PCT)
MIRR Graphs

Storage1MW - Government/Non-Profit - SDG&E

	Rebate	MIRR	PCT-2010
▲ Actual Rebate - 2010	\$2.00	-100.0%	0.55
■ No Rebate	\$0.00	-100.0%	0.25
● Rebate to Reach MIRR of 10%	\$0.00	0.0%	0.00
● Rebate to Reach MIRR of 11%	\$0.00	0.0%	0.00
● Rebate to Reach MIRR of 12%	\$0.00	0.0%	0.00
● Rebate to Reach MIRR of 13%	\$0.00	0.0%	0.00
● Rebate to Reach MIRR of 14%	\$0.00	0.0%	0.00
● Rebate to Reach MIRR of 15%	\$0.00	0.0%	0.00

System Cost per Watt: \$3.90

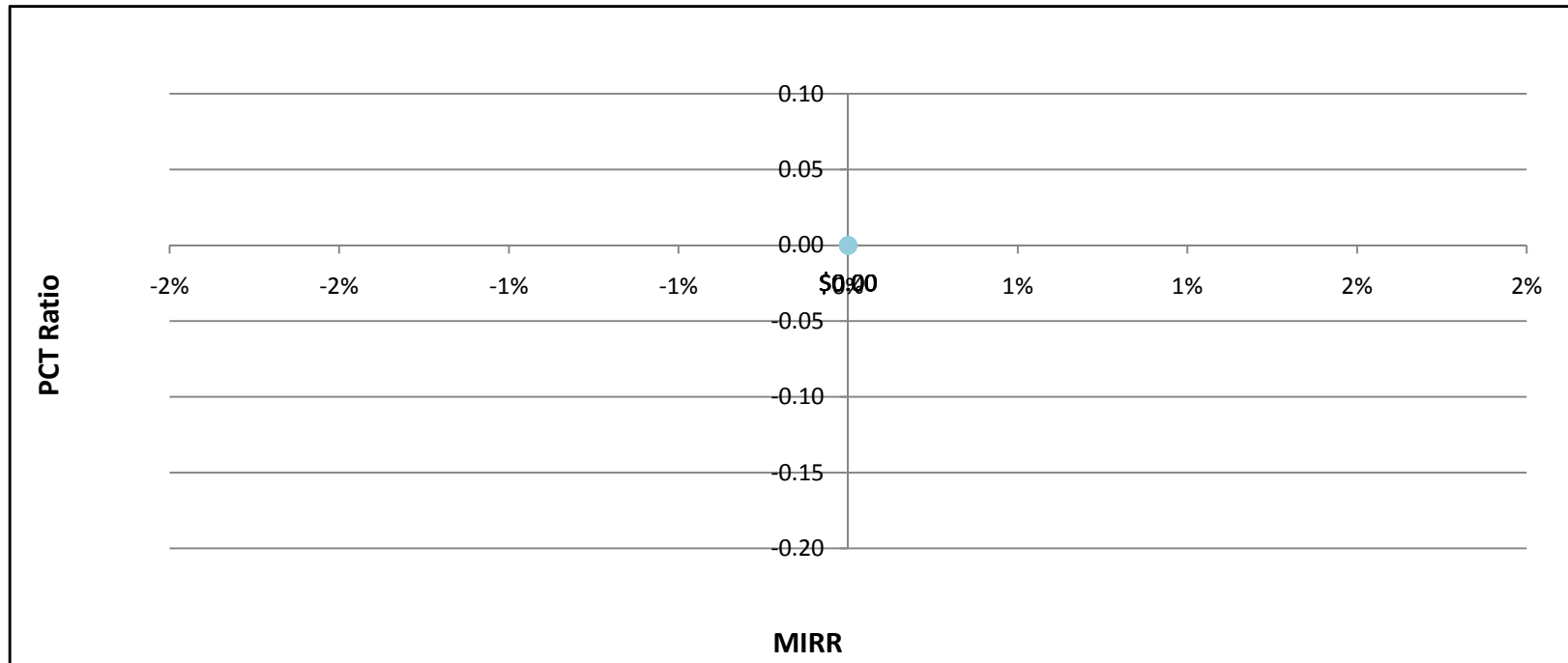

SGIP Cost Effectiveness Report
Participant Test Results (PCT)
MIRR Graphs

Storage1MW - Commercial - PG&E

	Rebate	MIRR	PCT-2010
▲ Actual Rebate - 2010	\$2.00	4.6%	0.69
■ No Rebate	\$0.00	-14.9%	0.51
● Rebate to Reach MIRR of 10%	\$0.00	0.0%	0.00
● Rebate to Reach MIRR of 11%	\$0.00	0.0%	0.00
● Rebate to Reach MIRR of 12%	\$0.00	0.0%	0.00
● Rebate to Reach MIRR of 13%	\$0.00	0.0%	0.00
● Rebate to Reach MIRR of 14%	\$0.00	0.0%	0.00
● Rebate to Reach MIRR of 15%	\$0.00	0.0%	0.00

System Cost per Watt: \$3.90

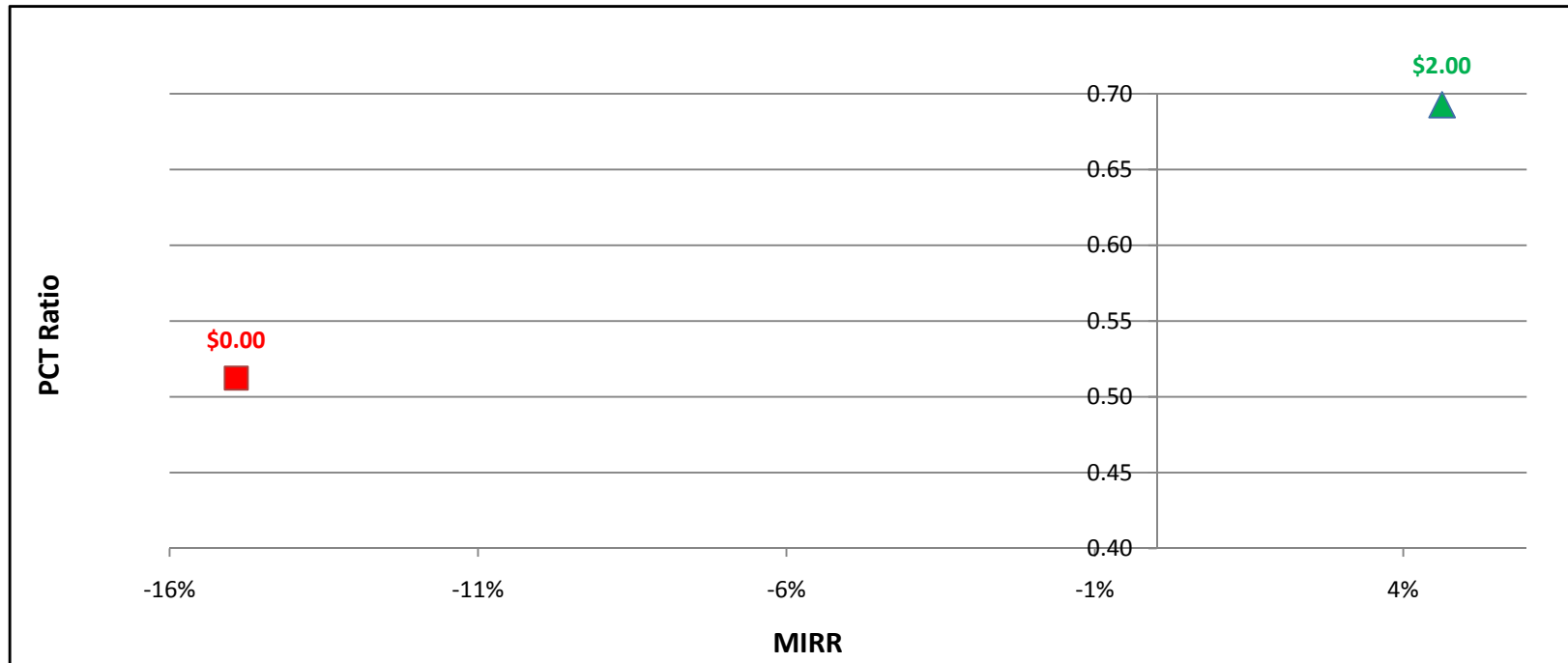

SGIP Cost Effectiveness Report
Participant Test Results (PCT)
MIRR Graphs

Storage1MW - Commercial - SCE

	Rebate	MIRR	PCT-2010
▲ Actual Rebate - 2010	\$2.00	4.7%	0.69
■ No Rebate	\$0.00	-13.9%	0.50
● Rebate to Reach MIRR of 10%	\$0.00	0.0%	0.00
● Rebate to Reach MIRR of 11%	\$0.00	0.0%	0.00
● Rebate to Reach MIRR of 12%	\$0.00	0.0%	0.00
● Rebate to Reach MIRR of 13%	\$0.00	0.0%	0.00
● Rebate to Reach MIRR of 14%	\$0.00	0.0%	0.00
● Rebate to Reach MIRR of 15%	\$0.00	0.0%	0.00

System Cost per Watt: \$3.90

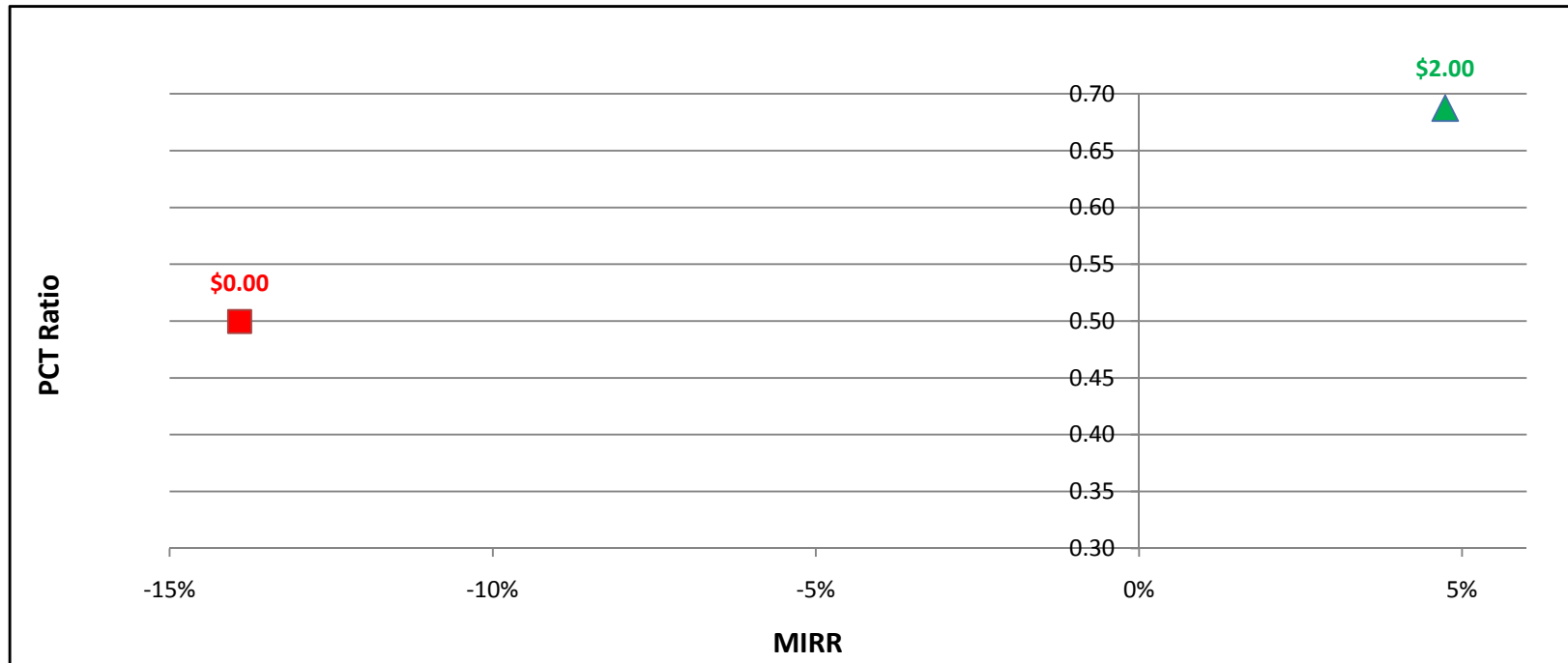

SGIP Cost Effectiveness Report
 Participant Test Results (PCT)
 MIRR Graphs

Storage1MW - Commercial - SDG&E

	Rebate	MIRR	PCT-2010
▲ Actual Rebate - 2010	\$2.00	4.8%	0.67
■ No Rebate	\$0.00	-13.4%	0.46
● Rebate to Reach MIRR of 10%	\$0.00	0.0%	0.00
● Rebate to Reach MIRR of 11%	\$0.00	0.0%	0.00
● Rebate to Reach MIRR of 12%	\$0.00	0.0%	0.00
● Rebate to Reach MIRR of 13%	\$0.00	0.0%	0.00
● Rebate to Reach MIRR of 14%	\$0.00	0.0%	0.00
● Rebate to Reach MIRR of 15%	\$0.00	0.0%	0.00

System Cost per Watt: \$3.90

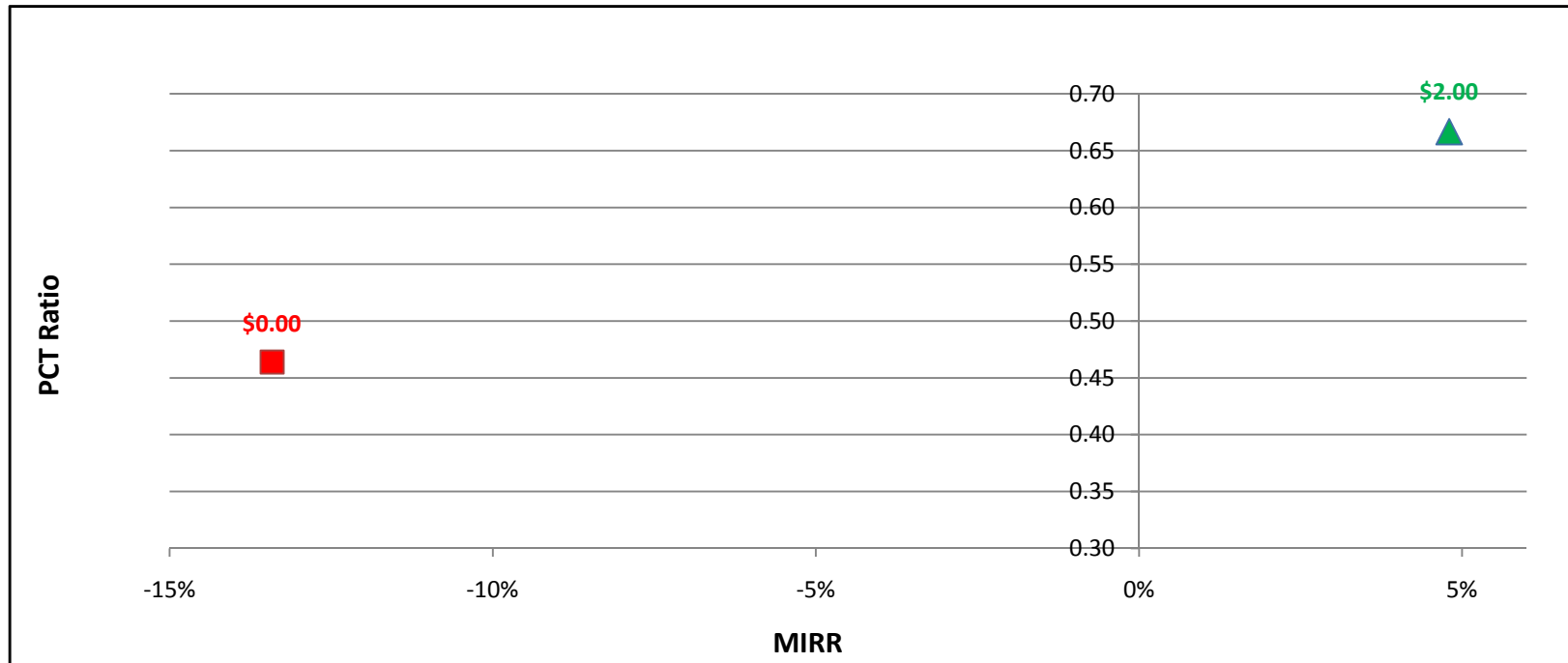

SGIP Cost Effectiveness Report
Participant Test Results (PCT)
MIRR Graphs

Storage25kW - Government/Non-Profit - PG&E

	Rebate	MIRR	PCT-2010
▲ Actual Rebate - 2010	\$2.00	-100.0%	0.42
■ No Rebate	\$0.00	-100.0%	0.24
● Rebate to Reach MIRR of 10%	\$0.00	0.0%	0.00
● Rebate to Reach MIRR of 11%	\$0.00	0.0%	0.00
● Rebate to Reach MIRR of 12%	\$0.00	0.0%	0.00
● Rebate to Reach MIRR of 13%	\$0.00	0.0%	0.00
● Rebate to Reach MIRR of 14%	\$0.00	0.0%	0.00
● Rebate to Reach MIRR of 15%	\$0.00	0.0%	0.00

System Cost per Watt: \$6.29

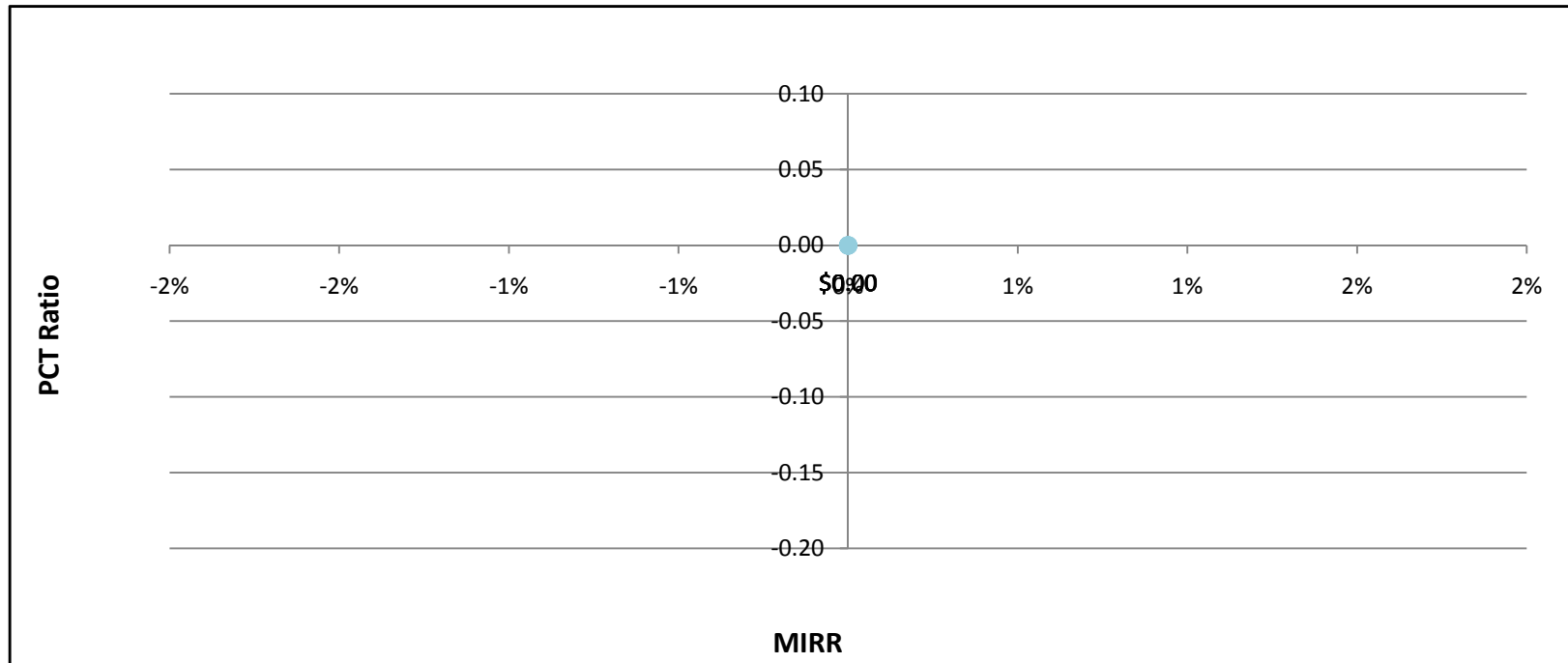

SGIP Cost Effectiveness Report
 Participant Test Results (PCT)
 MIRR Graphs

Storage25kW - Government/Non-Profit - SCE

	Rebate	MIRR	PCT-2010
▲ Actual Rebate - 2010	\$2.00	-100.0%	0.42
■ No Rebate	\$0.00	-100.0%	0.22
● Rebate to Reach MIRR of 10%	\$0.00	0.0%	0.00
● Rebate to Reach MIRR of 11%	\$0.00	0.0%	0.00
● Rebate to Reach MIRR of 12%	\$0.00	0.0%	0.00
● Rebate to Reach MIRR of 13%	\$0.00	0.0%	0.00
● Rebate to Reach MIRR of 14%	\$0.00	0.0%	0.00
● Rebate to Reach MIRR of 15%	\$0.00	0.0%	0.00

System Cost per Watt: \$6.29

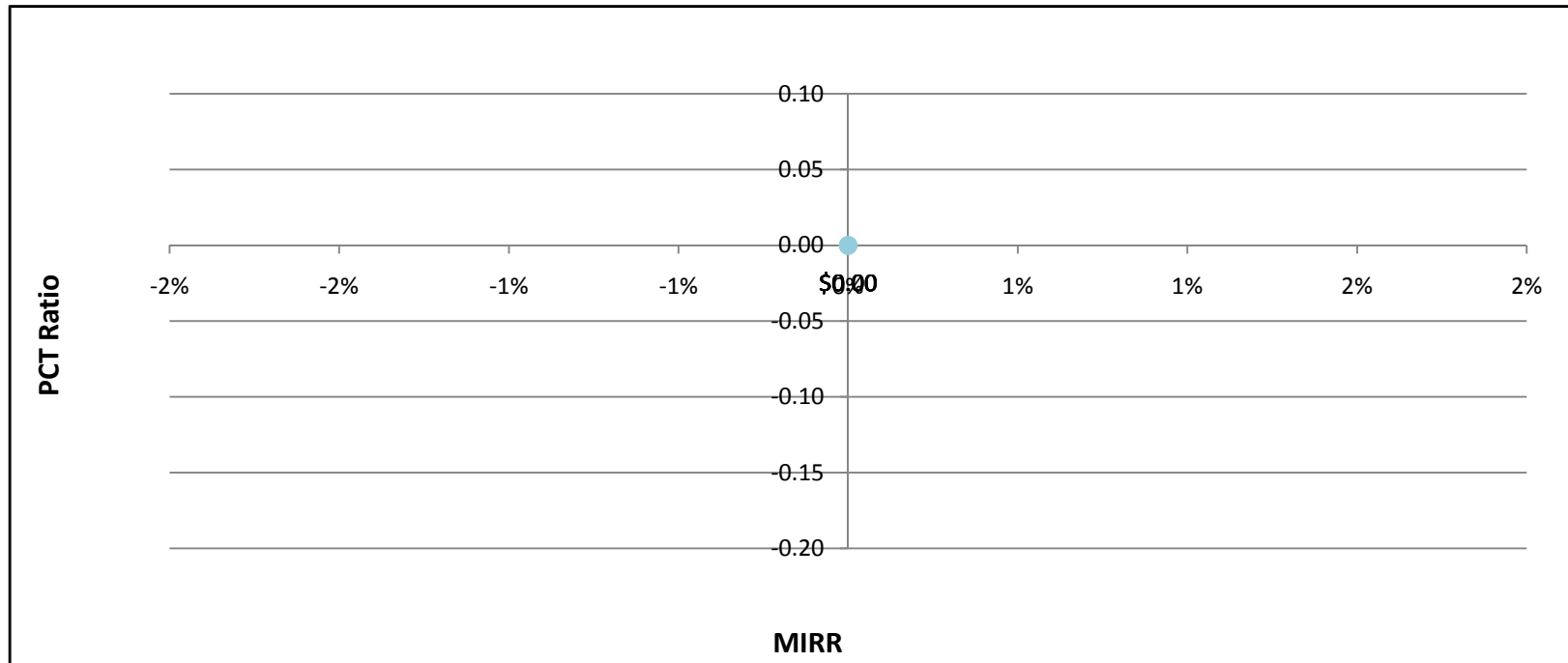

SGIP Cost Effectiveness Report
Participant Test Results (PCT)
MIRR Graphs

Storage25kW - Government/Non-Profit - SDG&E

	Rebate	MIRR	PCT-2010
▲ Actual Rebate - 2010	\$2.00	-100.0%	0.38
■ No Rebate	\$0.00	-100.0%	0.18
● Rebate to Reach MIRR of 10%	\$0.00	0.0%	0.00
● Rebate to Reach MIRR of 11%	\$0.00	0.0%	0.00
● Rebate to Reach MIRR of 12%	\$0.00	0.0%	0.00
● Rebate to Reach MIRR of 13%	\$0.00	0.0%	0.00
● Rebate to Reach MIRR of 14%	\$0.00	0.0%	0.00
● Rebate to Reach MIRR of 15%	\$0.00	0.0%	0.00

System Cost per Watt: \$6.29

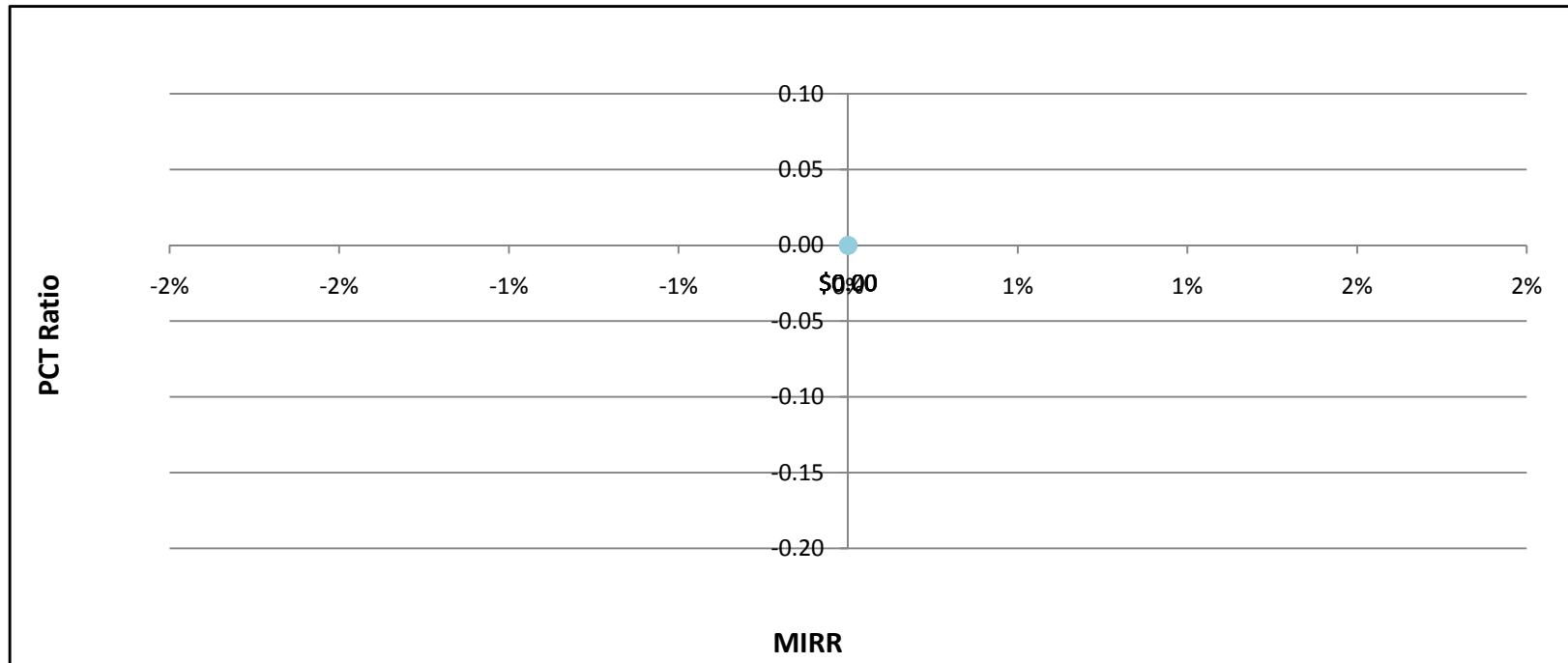

SGIP Cost Effectiveness Report
 Participant Test Results (PCT)
 MIRR Graphs

Storage25kW - Commercial - PG&E

	Rebate	MIRR	PCT-2010
▲ Actual Rebate - 2010	\$2.00	1.8%	0.58
■ No Rebate	\$0.00	-14.1%	0.46
● Rebate to Reach MIRR of 10%	\$0.00	0.0%	0.00
● Rebate to Reach MIRR of 11%	\$0.00	0.0%	0.00
● Rebate to Reach MIRR of 12%	\$0.00	0.0%	0.00
● Rebate to Reach MIRR of 13%	\$0.00	0.0%	0.00
● Rebate to Reach MIRR of 14%	\$0.00	0.0%	0.00
● Rebate to Reach MIRR of 15%	\$0.00	0.0%	0.00

System Cost per Watt: \$6.29

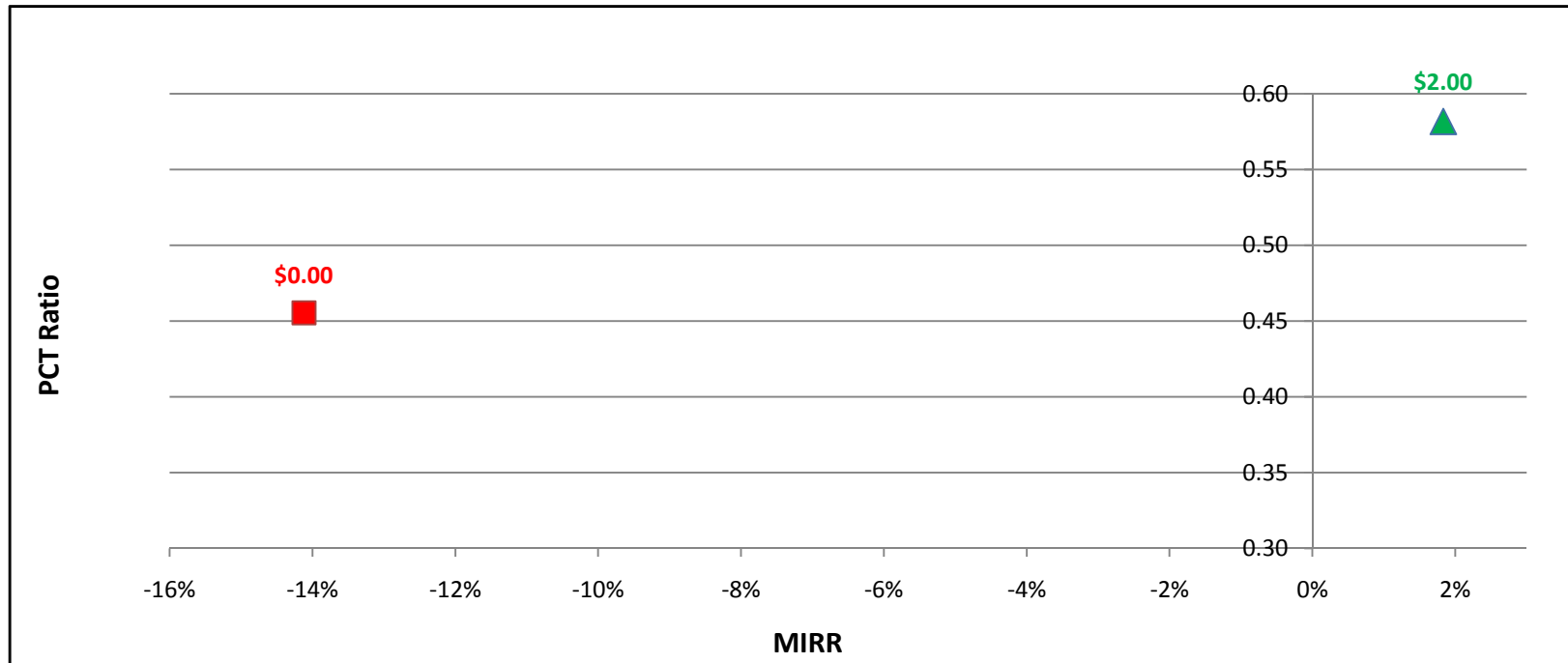

SGIP Cost Effectiveness Report
 Participant Test Results (PCT)
 MIRR Graphs

Storage25kW - Commercial - SCE

	Rebate	MIRR	PCT-2010
▲ Actual Rebate - 2010	\$2.00	1.9%	0.58
■ No Rebate	\$0.00	-13.4%	0.45
● Rebate to Reach MIRR of 10%	\$0.00	0.0%	0.00
● Rebate to Reach MIRR of 11%	\$0.00	0.0%	0.00
● Rebate to Reach MIRR of 12%	\$0.00	0.0%	0.00
● Rebate to Reach MIRR of 13%	\$0.00	0.0%	0.00
● Rebate to Reach MIRR of 14%	\$0.00	0.0%	0.00
● Rebate to Reach MIRR of 15%	\$0.00	0.0%	0.00

System Cost per Watt: \$6.29

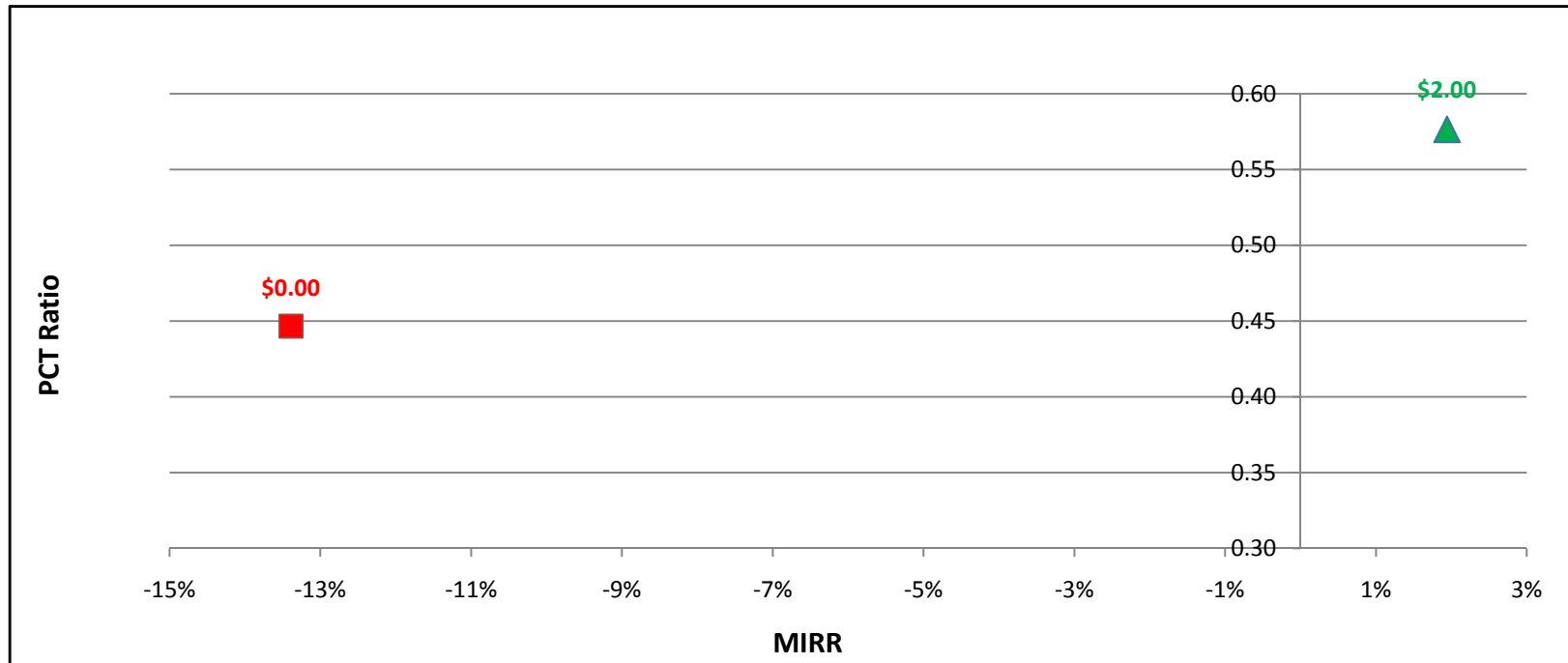

SGIP Cost Effectiveness Report
 Participant Test Results (PCT)
 MIRR Graphs

Storage25kW - Commercial - SDG&E

	Rebate	MIRR	PCT-2010
▲ Actual Rebate - 2010	\$2.00	2.0%	0.55
■ No Rebate	\$0.00	-13.3%	0.42
● Rebate to Reach MIRR of 10%	\$0.00	0.0%	0.00
● Rebate to Reach MIRR of 11%	\$0.00	0.0%	0.00
● Rebate to Reach MIRR of 12%	\$0.00	0.0%	0.00
● Rebate to Reach MIRR of 13%	\$0.00	0.0%	0.00
● Rebate to Reach MIRR of 14%	\$0.00	0.0%	0.00
● Rebate to Reach MIRR of 15%	\$0.00	0.0%	0.00

System Cost per Watt: \$6.29

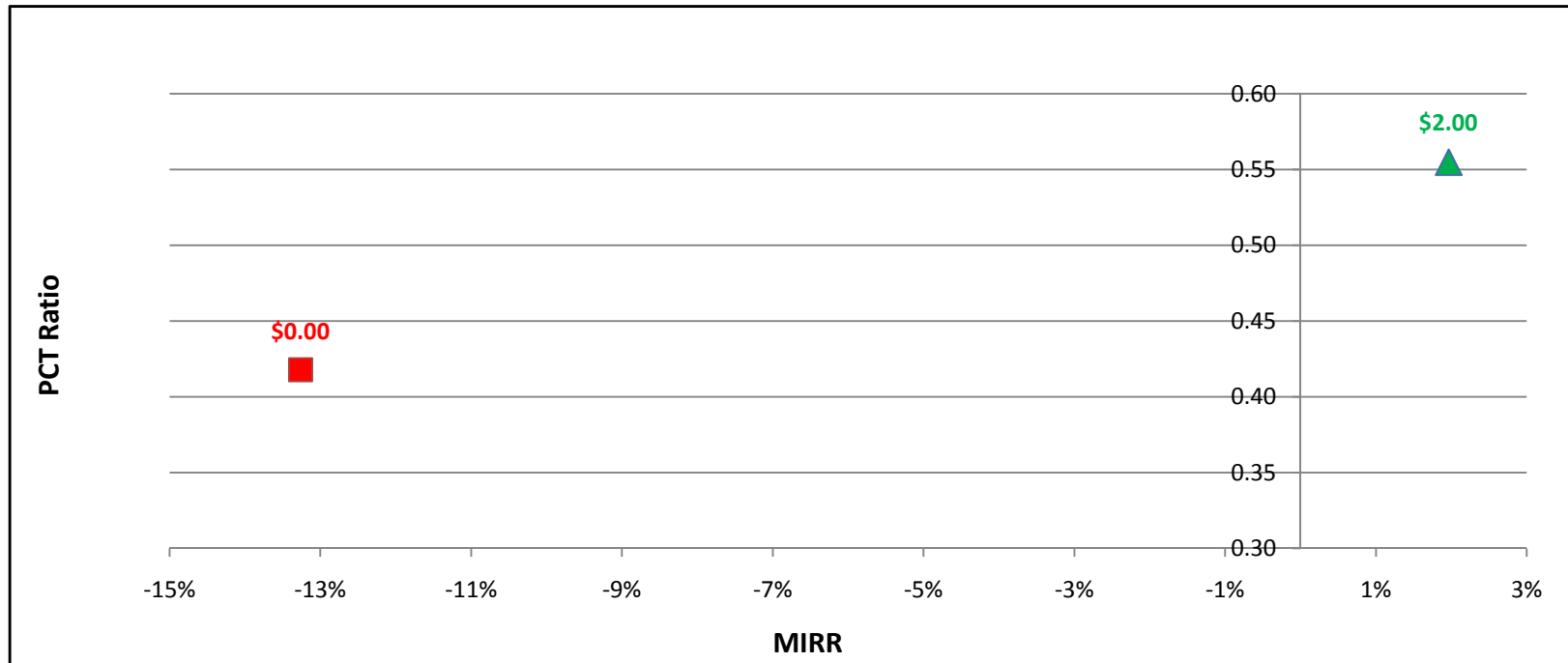

SGIP Cost Effectiveness Report
Participant Test Results (PCT)
MIRR Graphs

Storage25kW - Residential - PG&E

	Rebate	MIRR	PCT-2010
▲ Actual Rebate - 2010	\$2.00	-100.0%	0.46
■ No Rebate	\$0.00	-100.0%	0.28
● Rebate to Reach MIRR of 10%	\$0.00	0.0%	0.00
● Rebate to Reach MIRR of 11%	\$0.00	0.0%	0.00
● Rebate to Reach MIRR of 12%	\$0.00	0.0%	0.00
● Rebate to Reach MIRR of 13%	\$0.00	0.0%	0.00
● Rebate to Reach MIRR of 14%	\$0.00	0.0%	0.00
● Rebate to Reach MIRR of 15%	\$0.00	0.0%	0.00

System Cost per Watt: \$6.29

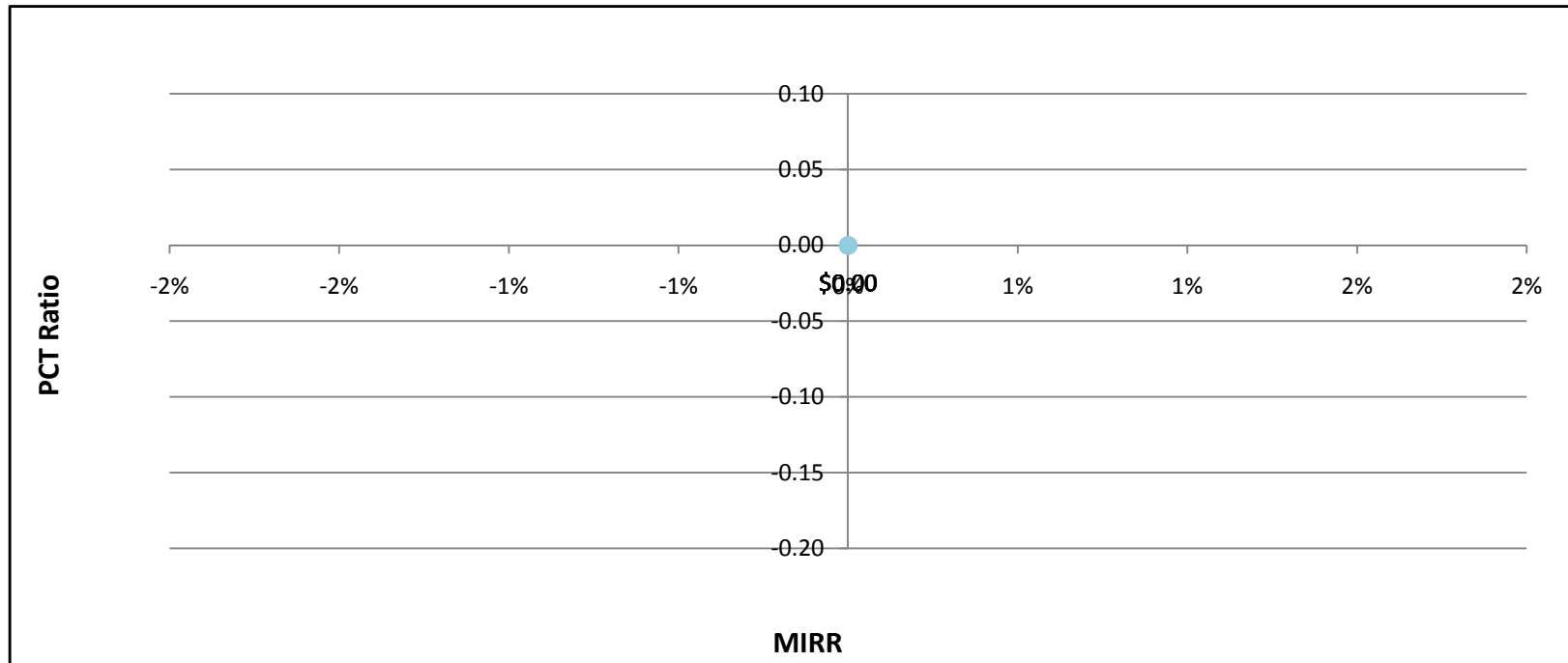

SGIP Cost Effectiveness Report
Participant Test Results (PCT)
MIRR Graphs

Storage25kW - Residential - SCE

	Rebate	MIRR	PCT-2010
▲ Actual Rebate - 2010	\$2.00	-100.0%	0.50
■ No Rebate	\$0.00	-100.0%	0.34
● Rebate to Reach MIRR of 10%	\$0.00	0.0%	0.00
● Rebate to Reach MIRR of 11%	\$0.00	0.0%	0.00
● Rebate to Reach MIRR of 12%	\$0.00	0.0%	0.00
● Rebate to Reach MIRR of 13%	\$0.00	0.0%	0.00
● Rebate to Reach MIRR of 14%	\$0.00	0.0%	0.00
● Rebate to Reach MIRR of 15%	\$0.00	0.0%	0.00

System Cost per Watt: \$6.29

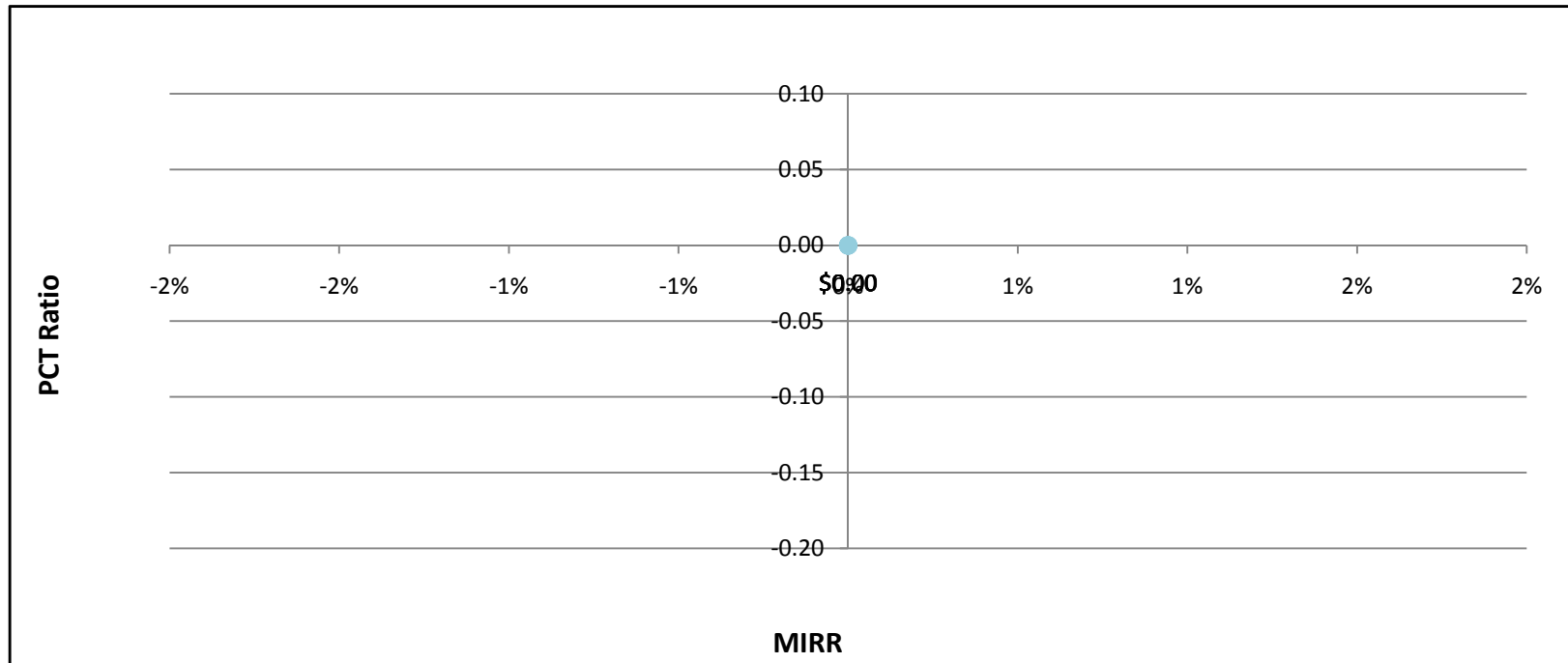

SGIP Cost Effectiveness Report
Participant Test Results (PCT)
MIRR Graphs

Storage25kW - Residential - SDG&E

	Rebate	MIRR	PCT-2010
▲ Actual Rebate - 2010	\$2.00	-100.0%	0.47
■ No Rebate	\$0.00	-100.0%	0.29
● Rebate to Reach MIRR of 10%	\$0.00	0.0%	0.00
● Rebate to Reach MIRR of 11%	\$0.00	0.0%	0.00
● Rebate to Reach MIRR of 12%	\$0.00	0.0%	0.00
● Rebate to Reach MIRR of 13%	\$0.00	0.0%	0.00
● Rebate to Reach MIRR of 14%	\$0.00	0.0%	0.00
● Rebate to Reach MIRR of 15%	\$0.00	0.0%	0.00

System Cost per Watt: \$6.29

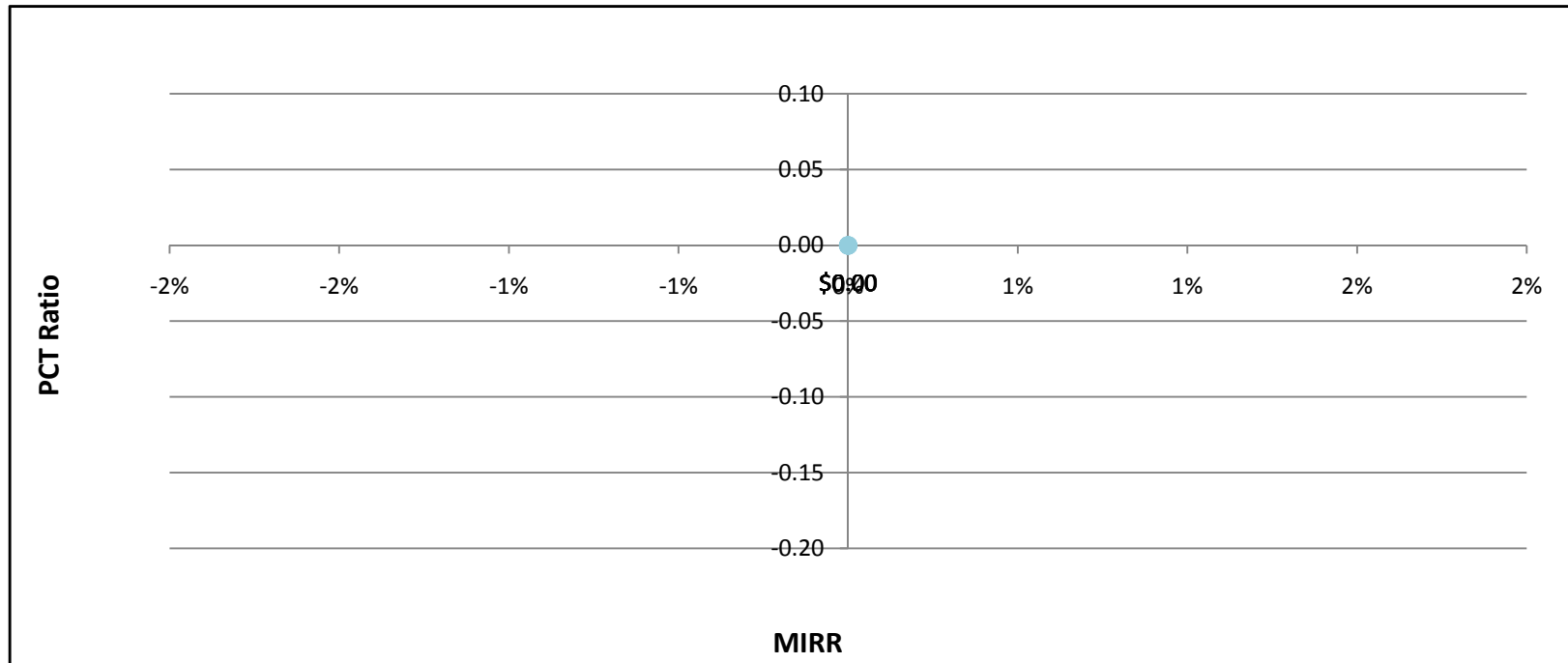

SGIP Cost Effectiveness Report
Participant Test Results (PCT)
MIRR Graphs

WD10kW - Residential - PG&E

	Rebate	MIRR	PCT-2010
▲ Actual Rebate - 2010	\$3.00	13.0%	1.51
■ No Rebate	\$0.00	7.8%	1.21
● Rebate to Reach MIRR of 10%	\$1.52	10.1%	1.37
● Rebate to Reach MIRR of 11%	\$2.07	11.0%	1.42
● Rebate to Reach MIRR of 12%	\$2.56	12.0%	1.47
● Rebate to Reach MIRR of 13%	\$3.00	13.0%	1.51
● Rebate to Reach MIRR of 14%	\$3.38	14.0%	1.55
● Rebate to Reach MIRR of 15%	\$3.72	15.0%	1.59

System Cost per Watt: \$5.84

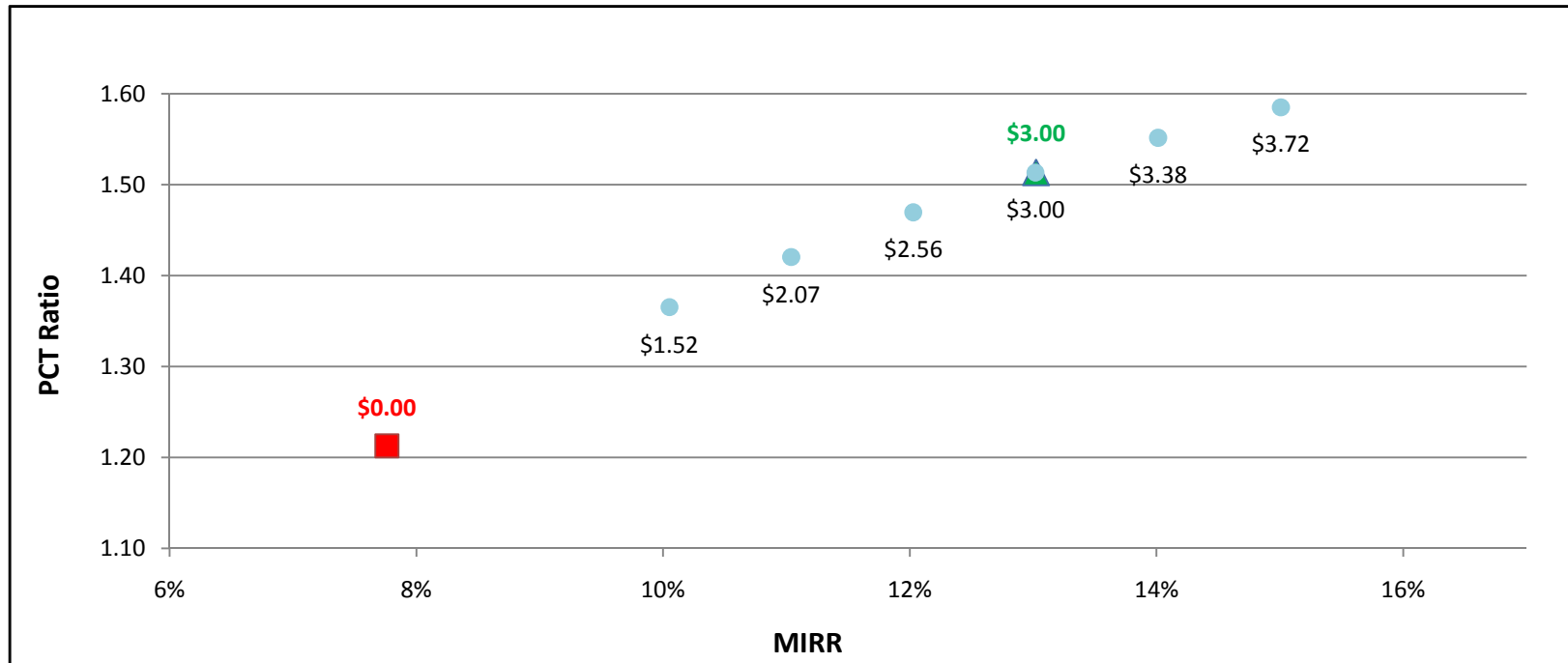

SGIP Cost Effectiveness Report
 Participant Test Results (PCT)
 MIRR Graphs

WD10kW - Residential - SCE

	Rebate	MIRR	PCT-2010
▲ Actual Rebate - 2010	\$3.00	14.6%	1.72
■ No Rebate	\$0.00	9.5%	1.42
● Rebate to Reach MIRR of 10%	\$0.37	10.0%	1.46
● Rebate to Reach MIRR of 11%	\$1.12	11.1%	1.53
● Rebate to Reach MIRR of 12%	\$1.74	12.1%	1.59
● Rebate to Reach MIRR of 13%	\$2.28	13.0%	1.65
● Rebate to Reach MIRR of 14%	\$2.76	14.0%	1.69
● Rebate to Reach MIRR of 15%	\$3.17	15.0%	1.74

System Cost per Watt: \$5.84

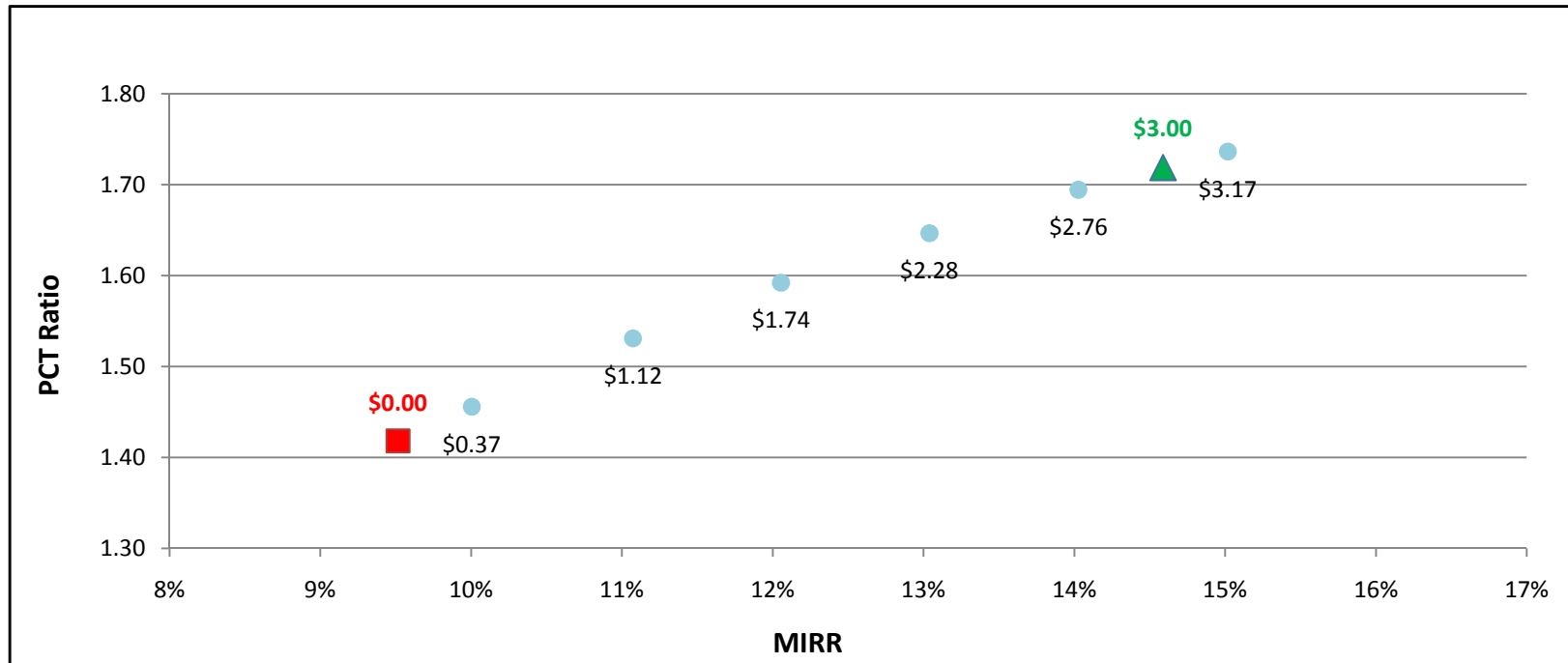

SGIP Cost Effectiveness Report
Participant Test Results (PCT)
MIRR Graphs

WD10kW - Residential - SDG&E

	Rebate	MIRR	PCT-2010
▲ Actual Rebate - 2010	\$3.00	13.1%	1.52
■ No Rebate	\$0.00	7.8%	1.22
● Rebate to Reach MIRR of 10%	\$1.49	10.1%	1.37
● Rebate to Reach MIRR of 11%	\$2.04	11.0%	1.42
● Rebate to Reach MIRR of 12%	\$2.54	12.0%	1.47
● Rebate to Reach MIRR of 13%	\$2.98	13.0%	1.52
● Rebate to Reach MIRR of 14%	\$3.36	14.0%	1.56
● Rebate to Reach MIRR of 15%	\$3.70	15.0%	1.59

System Cost per Watt: \$5.84

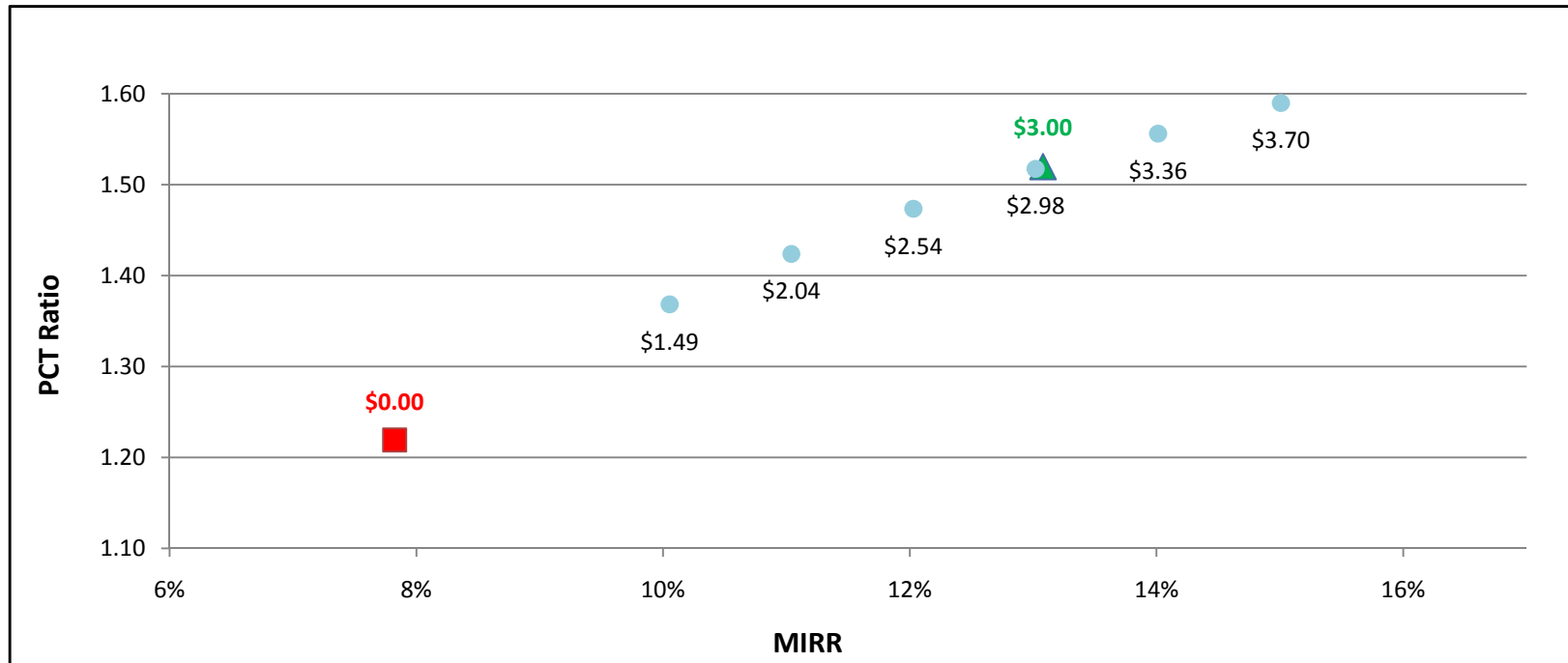

SGIP Cost Effectiveness Report
 Participant Test Results (PCT)
 MIRR Graphs

WD1MW - Government/Non-Profit - PG&E

	Rebate	MIRR	PCT-2010
▲ Actual Rebate - 2010	\$1.50	21.7%	2.83
■ No Rebate	\$0.00	12.9%	2.26
● Rebate to Reach MIRR of 10%	\$0.00	0.0%	0.00
● Rebate to Reach MIRR of 11%	\$0.00	0.0%	0.00
● Rebate to Reach MIRR of 12%	\$0.00	0.0%	0.00
● Rebate to Reach MIRR of 13%	\$0.02	13.0%	2.27
● Rebate to Reach MIRR of 14%	\$0.30	14.1%	2.37
● Rebate to Reach MIRR of 15%	\$0.52	15.1%	2.46

System Cost per Watt: \$2.13

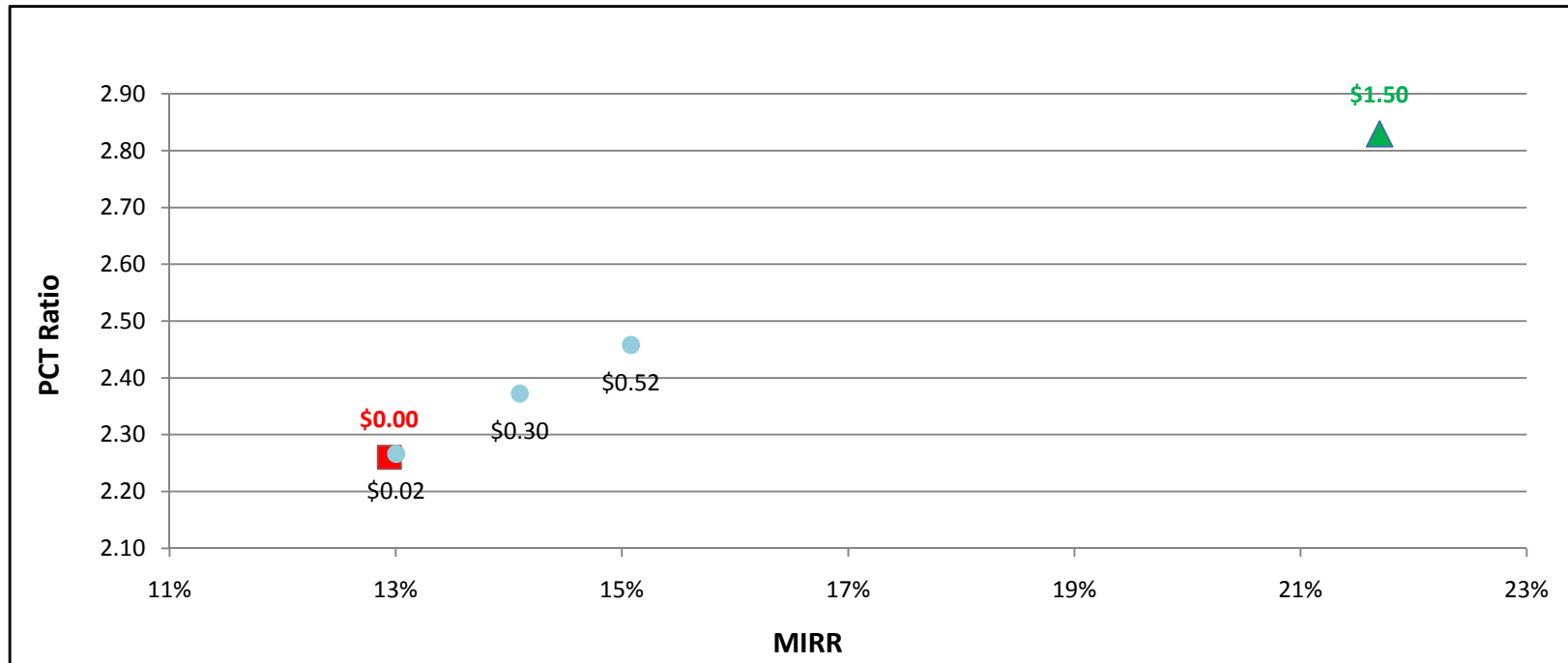

SGIP Cost Effectiveness Report
Participant Test Results (PCT)
MIRR Graphs

WD1MW - Government/Non-Profit - SCE

	Rebate	MIRR	PCT-2010
▲ Actual Rebate - 2010	\$1.50	21.3%	2.72
■ No Rebate	\$0.00	12.5%	2.15
● Rebate to Reach MIRR of 10%	\$0.00	0.0%	0.00
● Rebate to Reach MIRR of 11%	\$0.00	0.0%	0.00
● Rebate to Reach MIRR of 12%	\$0.00	0.0%	0.00
● Rebate to Reach MIRR of 13%	\$0.13	13.0%	2.20
● Rebate to Reach MIRR of 14%	\$0.39	14.1%	2.30
● Rebate to Reach MIRR of 15%	\$0.60	15.1%	2.38

System Cost per Watt: \$2.13

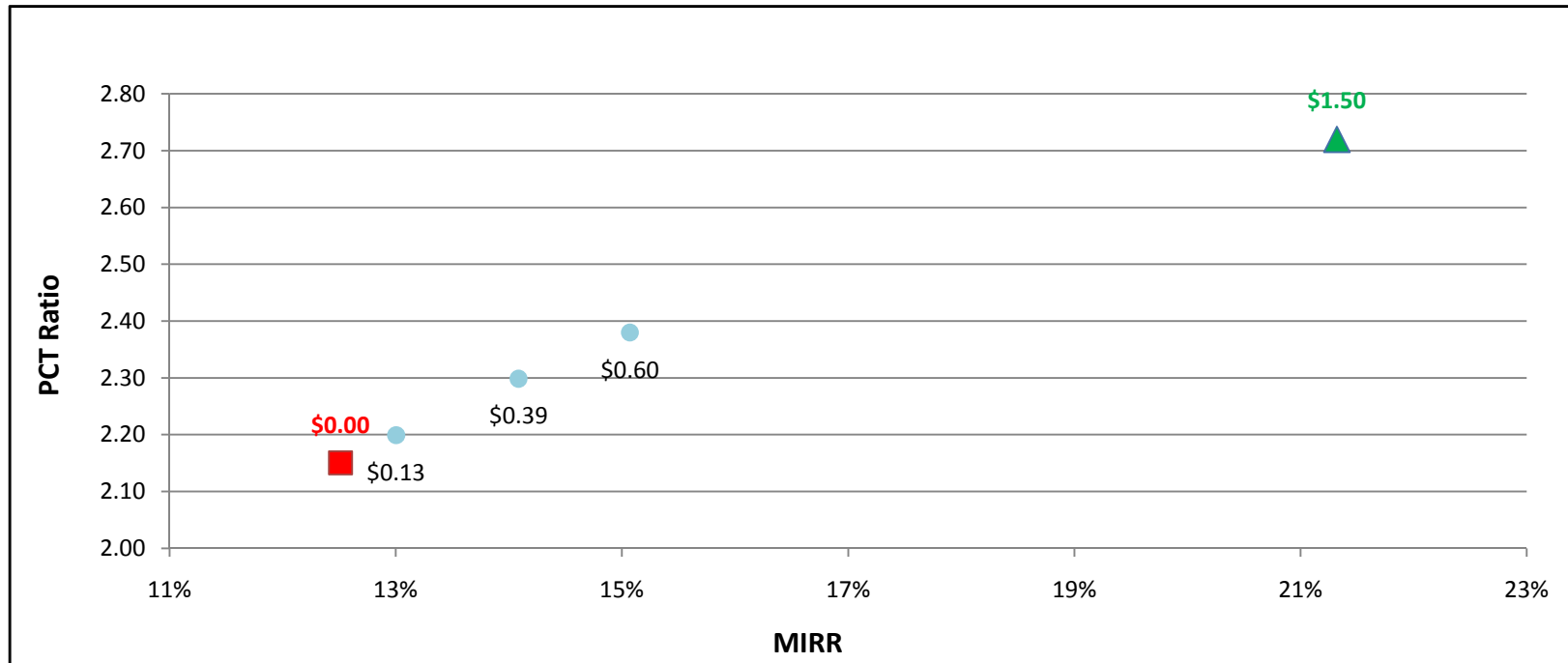

SGIP Cost Effectiveness Report
 Participant Test Results (PCT)
 MIRR Graphs

WD1MW - Government/Non-Profit - SDG&E

	Rebate	MIRR	PCT-2010
▲ Actual Rebate - 2010	\$1.50	19.4%	2.25
■ No Rebate	\$0.00	10.2%	1.68
● Rebate to Reach MIRR of 10%	\$0.00	0.0%	0.00
● Rebate to Reach MIRR of 11%	\$0.20	11.1%	1.76
● Rebate to Reach MIRR of 12%	\$0.42	12.1%	1.84
● Rebate to Reach MIRR of 13%	\$0.62	13.1%	1.92
● Rebate to Reach MIRR of 14%	\$0.80	14.0%	1.99
● Rebate to Reach MIRR of 15%	\$0.96	15.0%	2.05

System Cost per Watt: \$2.13

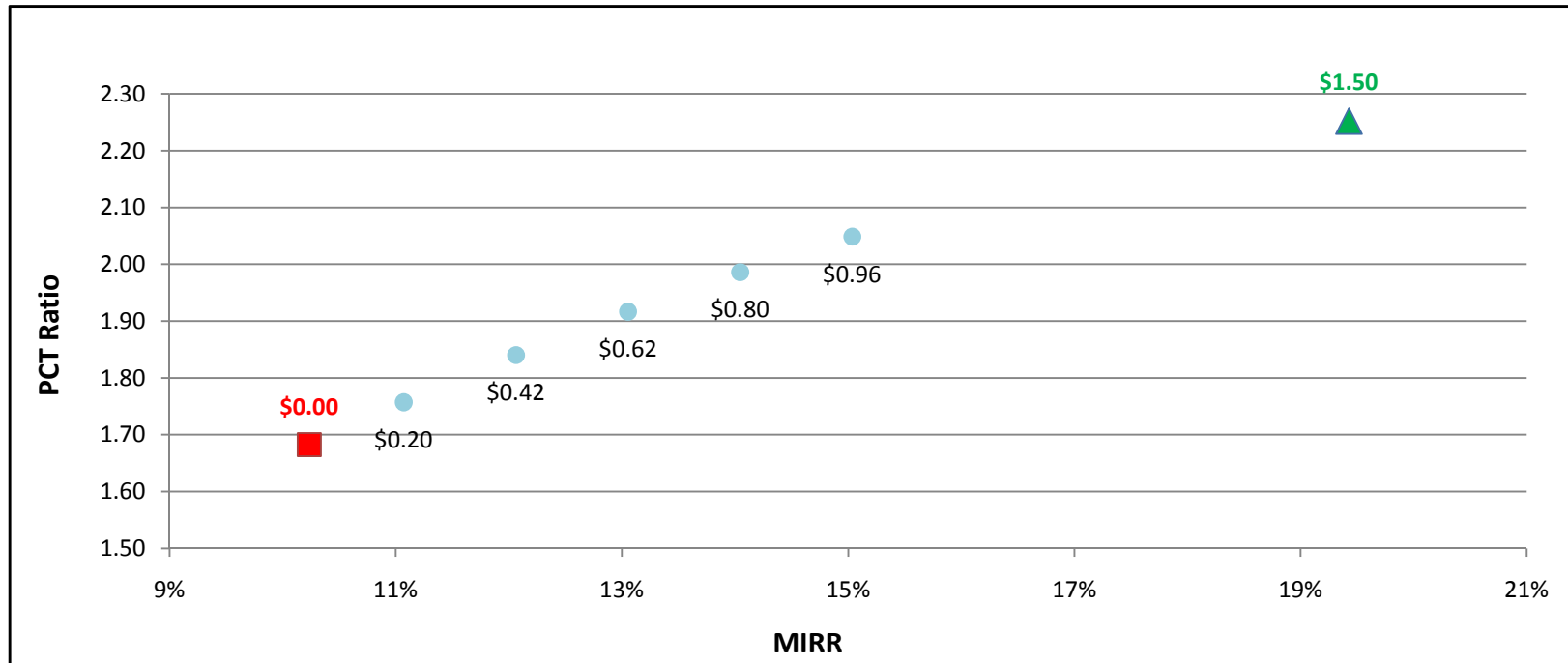

SGIP Cost Effectiveness Report
Participant Test Results (PCT)
MIRR Graphs

WD1MW - Commercial - PG&E

	Rebate	MIRR	PCT-2010
▲ Actual Rebate - 2010	\$1.50	16.4%	1.98
■ No Rebate	\$0.00	14.5%	1.62
● Rebate to Reach MIRR of 10%	\$0.00	0.0%	0.00
● Rebate to Reach MIRR of 11%	\$0.00	0.0%	0.00
● Rebate to Reach MIRR of 12%	\$0.00	0.0%	0.00
● Rebate to Reach MIRR of 13%	\$0.00	0.0%	0.00
● Rebate to Reach MIRR of 14%	\$0.00	0.0%	0.00
● Rebate to Reach MIRR of 15%	\$0.36	15.0%	1.71

System Cost per Watt: \$2.13

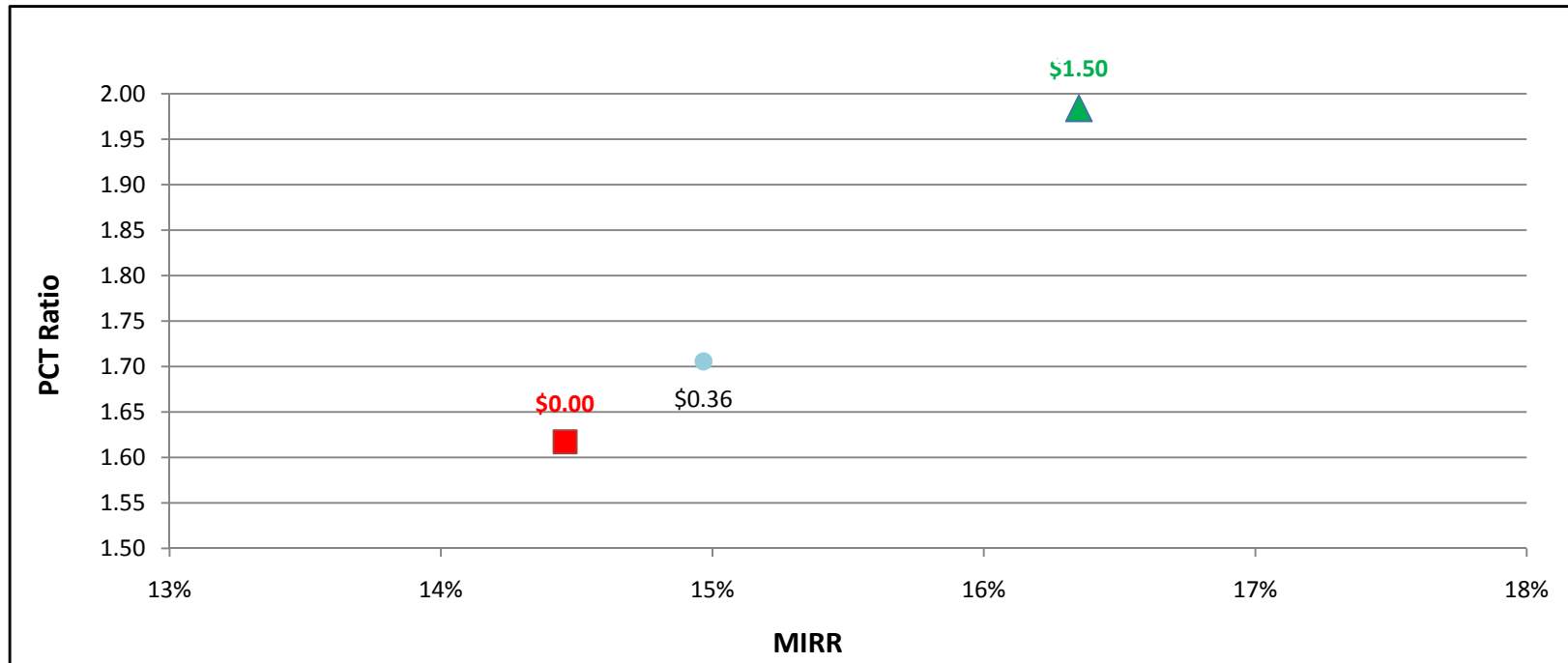

SGIP Cost Effectiveness Report
 Participant Test Results (PCT)
 MIRR Graphs

WD1MW - Commercial - SCE

	Rebate	MIRR	PCT-2010
▲ Actual Rebate - 2010	\$1.50	16.2%	1.94
■ No Rebate	\$0.00	14.2%	1.57
● Rebate to Reach MIRR of 10%	\$0.00	0.0%	0.00
● Rebate to Reach MIRR of 11%	\$0.00	0.0%	0.00
● Rebate to Reach MIRR of 12%	\$0.00	0.0%	0.00
● Rebate to Reach MIRR of 13%	\$0.00	0.0%	0.00
● Rebate to Reach MIRR of 14%	\$0.00	0.0%	0.00
● Rebate to Reach MIRR of 15%	\$0.61	15.1%	1.72

System Cost per Watt: \$2.13

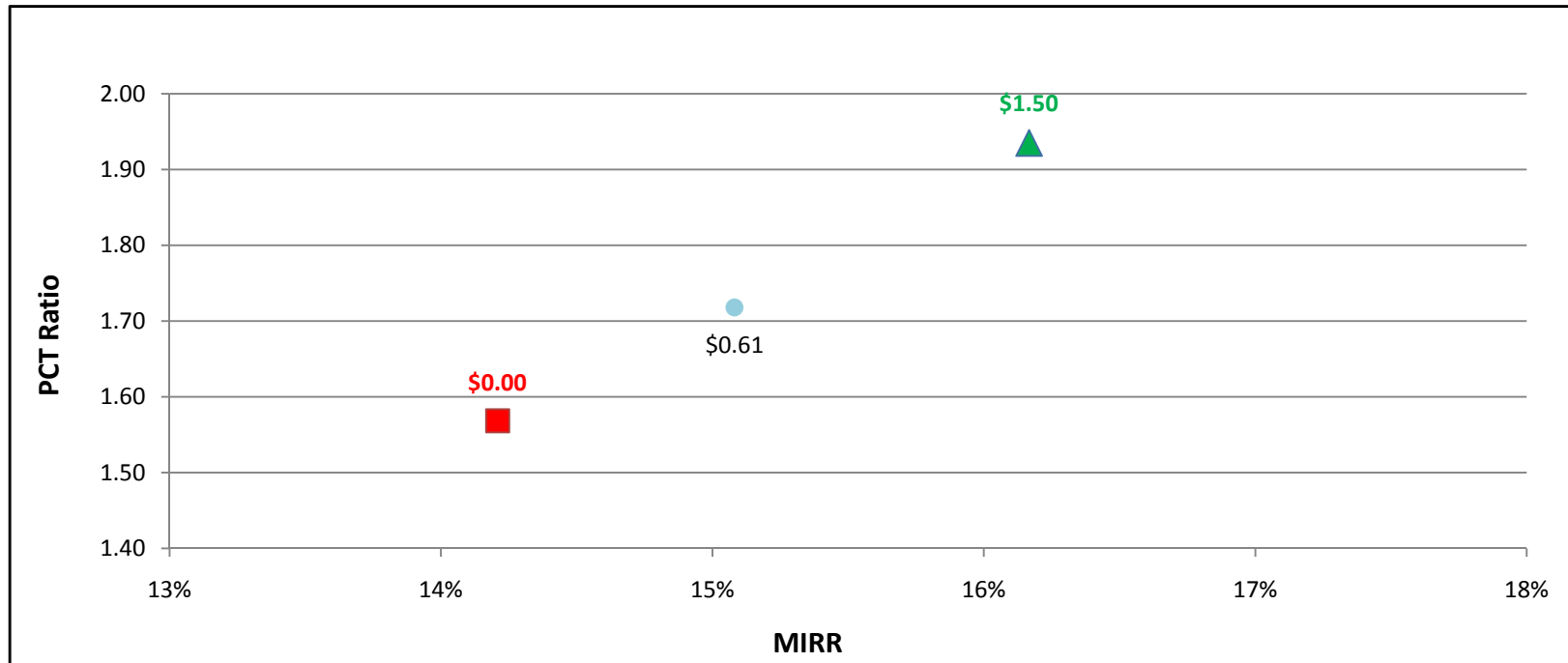

SGIP Cost Effectiveness Report
Participant Test Results (PCT)
MIRR Graphs

WD1MW - Commercial - SDG&E

	Rebate	MIRR	PCT-2010
▲ Actual Rebate - 2010	\$1.50	15.3%	1.73
■ No Rebate	\$0.00	13.0%	1.36
● Rebate to Reach MIRR of 10%	\$0.00	0.0%	0.00
● Rebate to Reach MIRR of 11%	\$0.00	0.0%	0.00
● Rebate to Reach MIRR of 12%	\$0.00	0.0%	0.00
● Rebate to Reach MIRR of 13%	\$0.00	0.0%	0.00
● Rebate to Reach MIRR of 14%	\$0.61	14.1%	1.51
● Rebate to Reach MIRR of 15%	\$1.24	15.0%	1.66

System Cost per Watt: \$2.13

